

ASSEMBLY INSTRUCTION

SKU CODE : (WF286322/WF286323)

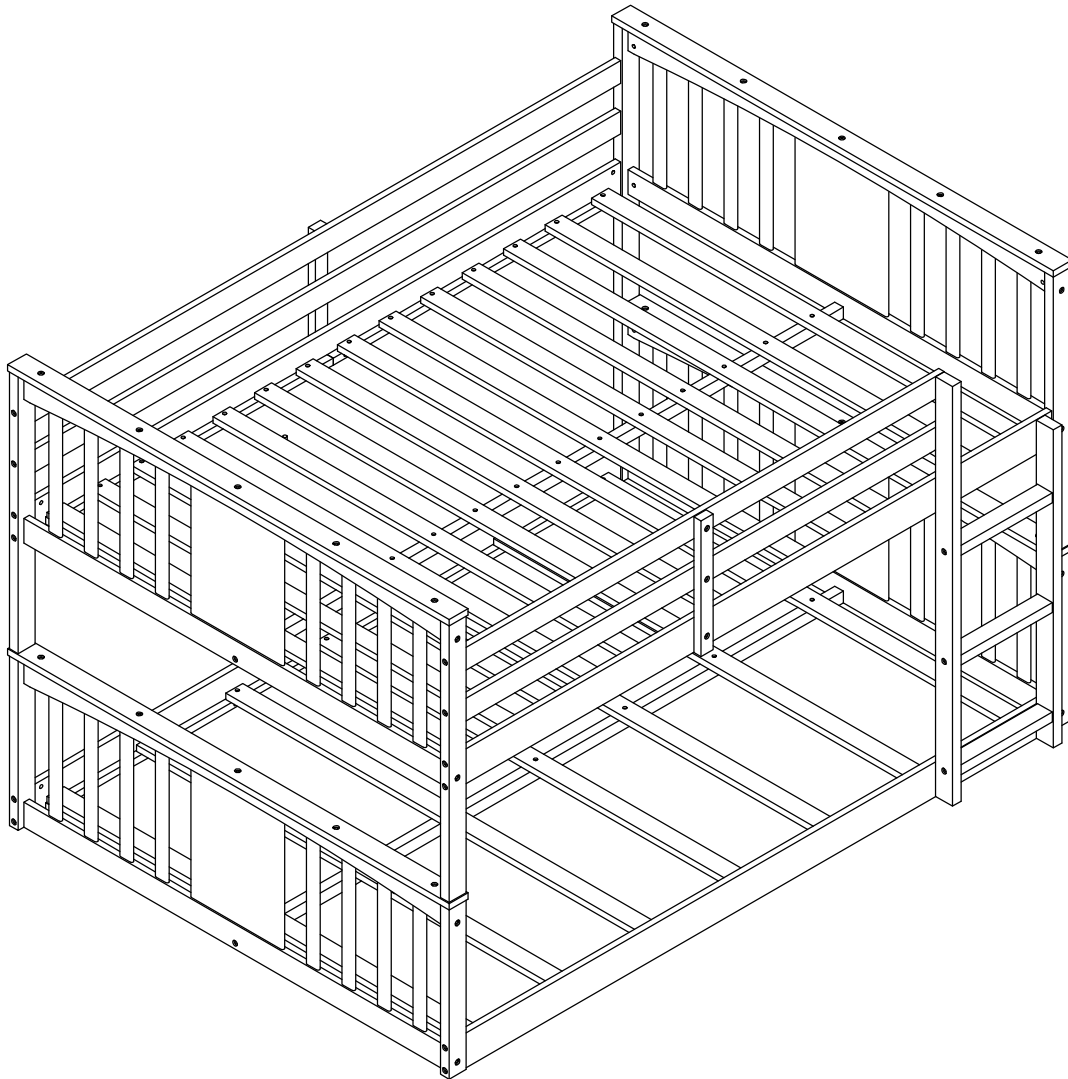



SAFETY WARNINGS

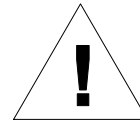

1. This bed is designed for use only mattress(es) meeting the following specifications on the upper bunk, and lower bunk:

Upper bunk (bunk bed and tribed included)

Bed Type	Length	Width	Thickness
Full Standard	74"-75"	53"-54"	6" max

Lower bunk

Bed Type	Length	Width	Thickness
Full Standard	74"-75"	53"-54"	8"

2. Replacement parts, including additional guardrails, maybe obtained from any of our (GIGACLOUD TECHNOLOGY (USA) INC. 18961 ARENTH AVENUE CITY OF INDUSTRY, CA, 91748) dealers.
3. Follow the information on the warnings appearing on the upper bunk bed end structure and on the carton. Do not remove warning label from bed.
4. Always use the recommended size mattresses or mattress supports, or both, to help prevent the likelihood of entrapment or falls.
5. Surface of the mattress must be at least 5" . (127 mm) below the upper edge of guardrails.
6. Do not allow children under 6 years of age to use the upper bunk.
7. Periodically check and ensure that the guardrail, ladder, and other components are in their proper position, free from damage, and that all connectors are tight.
8. Do not allow horseplay on or under the bed and prohibit jumping on the bed
9. Always use the ladder for entering and leaving the upper bunk.
10. Do not use substitute parts. Contact the manufacturer or dealer for replacement parts.
11. Use of a night light may provided added safety precaution for a child using the upper bunk.
12. Always use guardrails on both long sides of the upper bunk. If the bunk bed will be placed next to the wall, the guardrail that runs the full length of the bed should be placed against the wall to prevent entrapment between the bed and wall.
13. The use of water or sleep flotation mattresses is prohibited.
14. STRANGULATION HAZARD – Never attach or hang items to any part of the bunk bed that are not designed for use with the bed; for example, but not limited to, hook, belts and jump ropes.
15. Keep these instructions for future reference
16. Prohibit more than one person on upper bunk.
17. We recommend assembling your bunk bed on the shipping carton to protect your floor or carpet.
18. Be certain all staples are out of the box before beginning assembly on the shipping carton.

Detail View - FULL BED

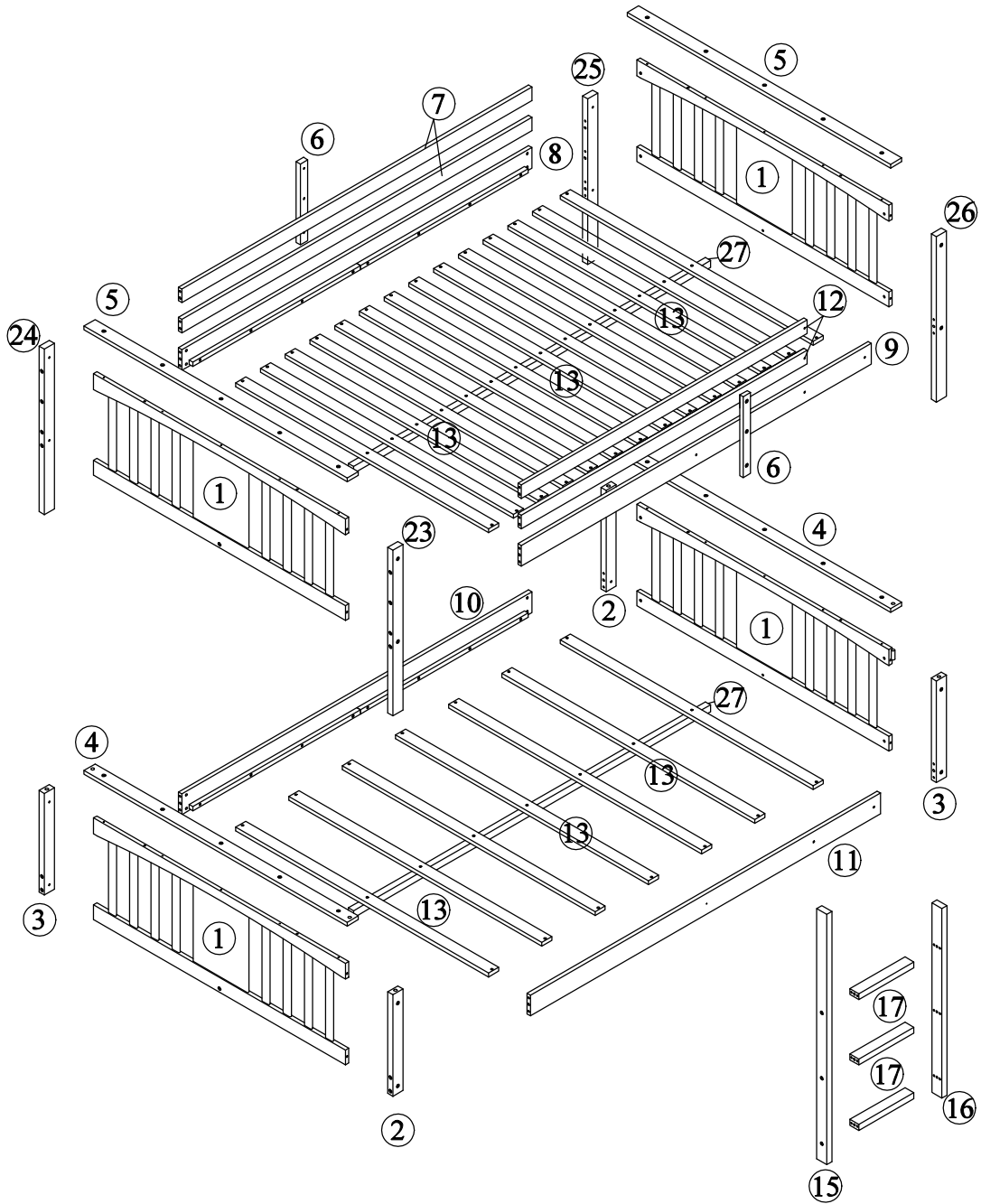

Identifying the Hardware-Identify the hardware using the illustrations below.

Part List—WF286322

1

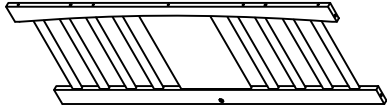







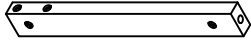
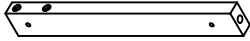

Headboard - 4pcs

13

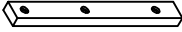

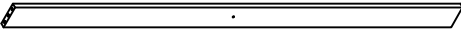
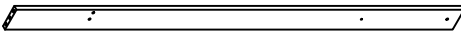

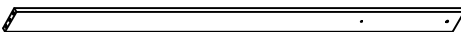
Bed board - 21pcs

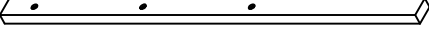



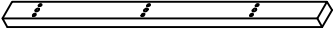
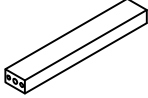

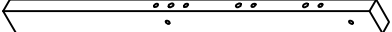
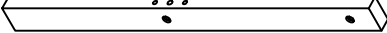
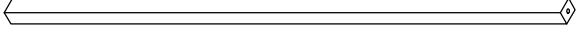



Part List—WF286323

<p>2</p>  <p>Left front + Right rear bed column - 2pcs</p>	<p>3</p>  <p>Right front + Left rear bed column - 2pcs</p>
<p>4</p>  <p>Headboard cap -2pcs</p>	<p>5</p>  <p>Headboard cap -2pcs</p>
<p>6</p>  <p>Support timber -2pcs</p>	<p>7</p>  <p>Rear guard rail - 2pcs</p>
<p>8</p>  <p>Bed side plate - 1pc</p>	<p>9</p>  <p>Bed side plate - 1pc</p>
<p>10</p>  <p>Bed side plate - 1pc</p>	<p>11</p>  <p>Bed side plate - 1pc</p>
<p>12</p>  <p>Front guard rail - 2pcs</p>	<p>15</p>  <p>Bed ladder column - 1pc</p>

Part List—WF286323

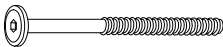
<p>16</p>  <p>Bed ladder column - 1pc</p>	<p>17</p>  <p>Ladder step - 3pcs</p>
<p>23</p>  <p>Left front bed column - 1pc</p>	<p>24</p>  <p>Left rear bed column - 1pc</p>
<p>25</p>  <p>Right rear bed column - 1pc</p>	<p>26</p>  <p>Right front bed column - 1pc</p>
<p>27</p>  <p>Reinforcement bar - 2pcs</p>	



Hardware List—WF286322

<p>A</p>  <p>$\varnothing 10 \times 40 \text{mm}$</p>	<p>B</p>  <p>$\varnothing 14 \times 100 \text{mm}$</p>	<p>C</p>  <p>$\varnothing 13 \times \varnothing 6.2 \times 27 \text{mm}$</p>
<p>Wood dowel(34pcs)</p>	<p>Wood dowel(4pcs)</p>	<p>Hex-Head screw(6pcs)</p>
<p>D</p>  <p>$\varnothing 13 \times \varnothing 6.2 \times 32 \text{mm}$</p>	<p>E</p>  <p>$\varnothing 13 \times \varnothing 6.2 \times 50 \text{mm}$</p>	<p>F</p>  <p>$\varnothing 13 \times \varnothing 6.2 \times 80 \text{mm}$</p>
<p>Hex-Head screw(30pcs)</p>	<p>Hex-Head screw(6pcs)</p>	<p>Hex-Head screw(6pcs)</p>
<p>G</p>  <p>$\varnothing 13 \times 1/4" \times 57 \text{mm}$</p>	<p>H</p>  <p>$\varnothing 13 \times 1/4" \times 100 \text{mm}$</p>	<p>I</p>  <p>$\varnothing 1/4 \times \varnothing 10 \times 12.5 \text{mm}$</p>
<p>Hex-Head bolts(16pcs)</p>	<p>Hex-Head bolts(16pcs)</p>	<p>Horizontal-Hole bolts(32pcs)</p>
<p>J</p>  <p>$\varnothing 8 \times \varnothing 4 \times 30 \text{mm}$</p>	<p>K</p>  <p>4mm</p>	
<p>Round head screw(63pcs)</p>	<p>Allen key(1pc)</p>	

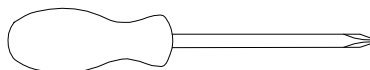
ASSEMBLY TOOLS REQUIRED (NOT INCLUDED)



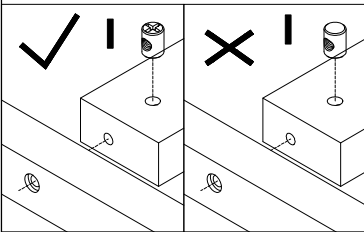
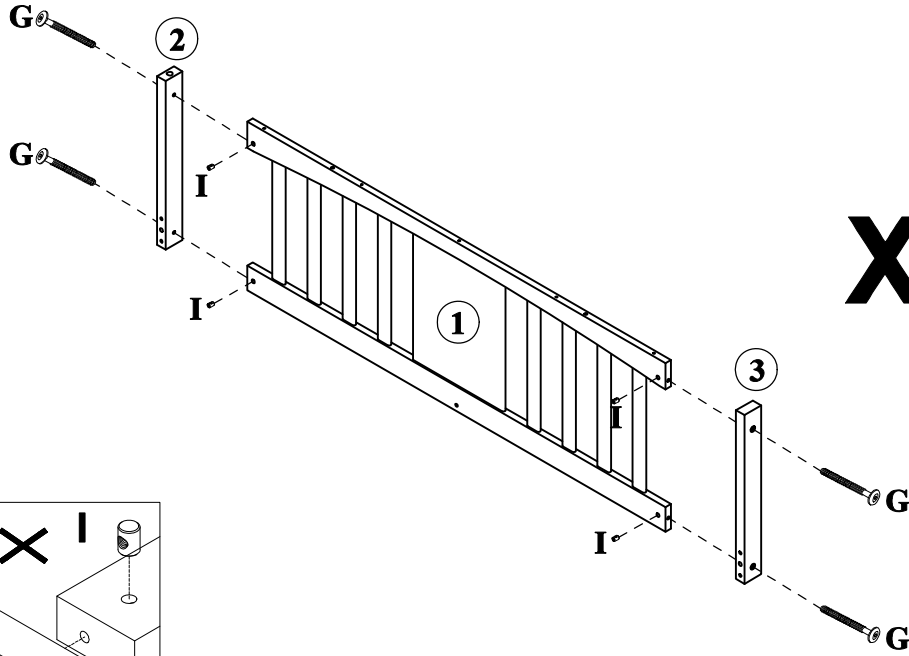

STEP: 1

G	I
	
8PCS	8PCS



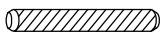
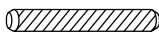

STEP: 2

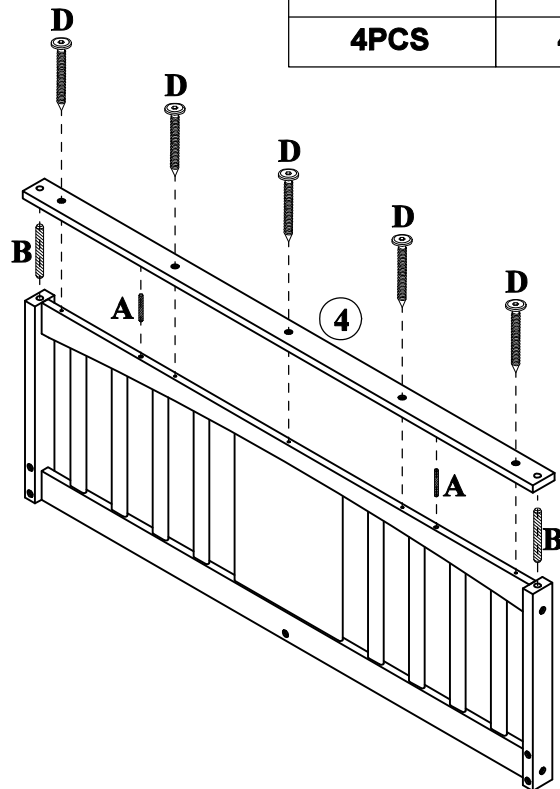
A	B	D
		
4PCS	4PCS	10PCS



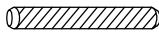
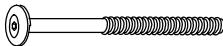

STEP: 3

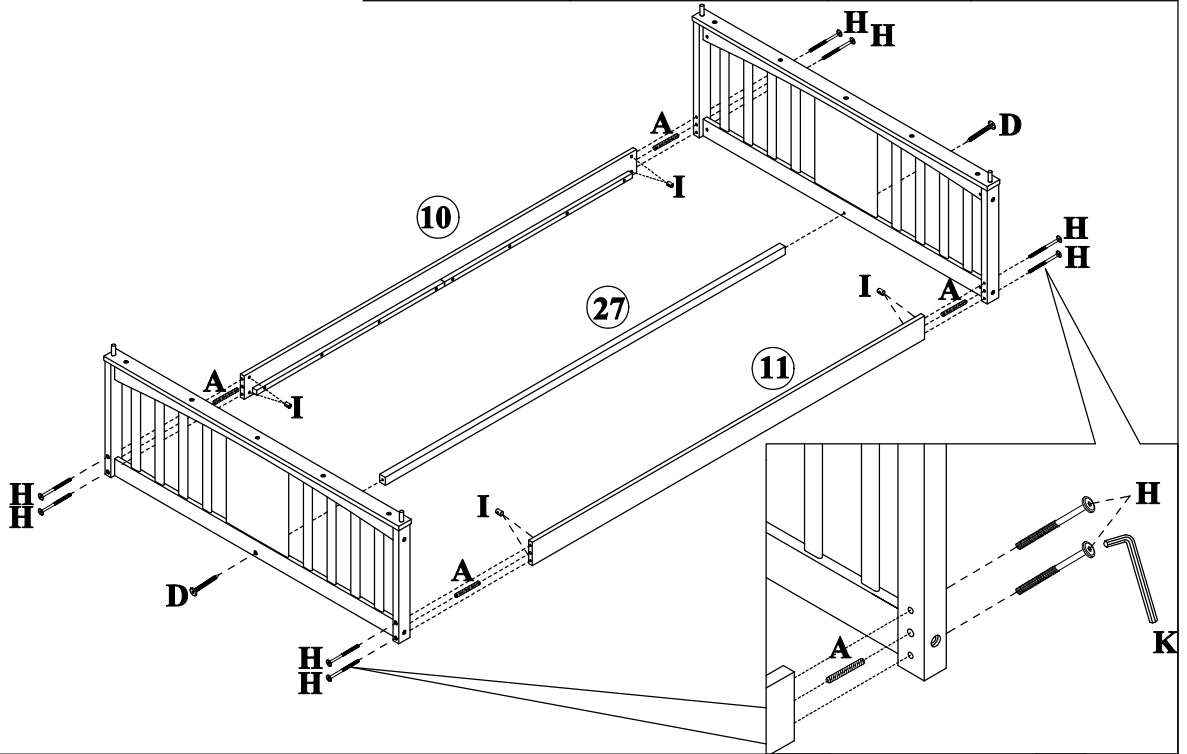
A	H	I	D
			
4PCS	8PCS	8PCS	2PCS



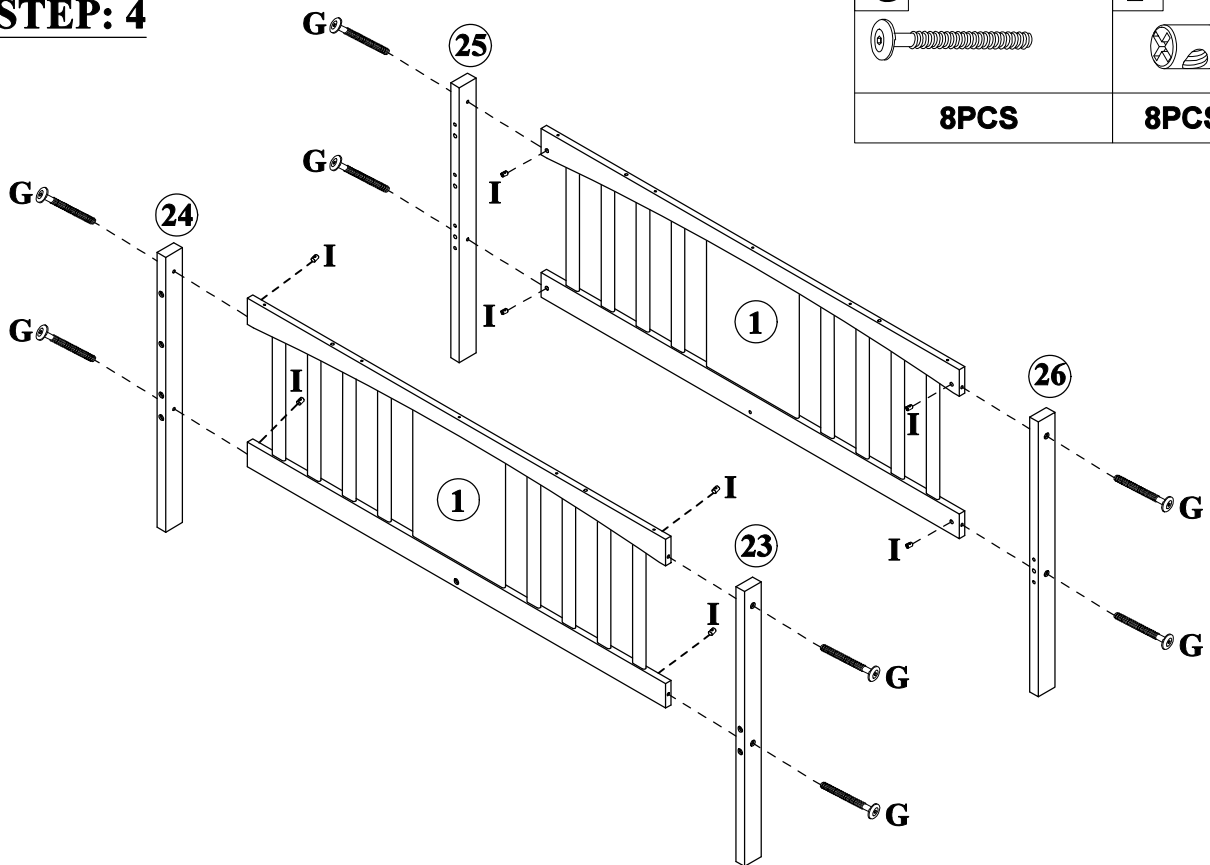

STEP: 4

G	I
	
8PCS	8PCS



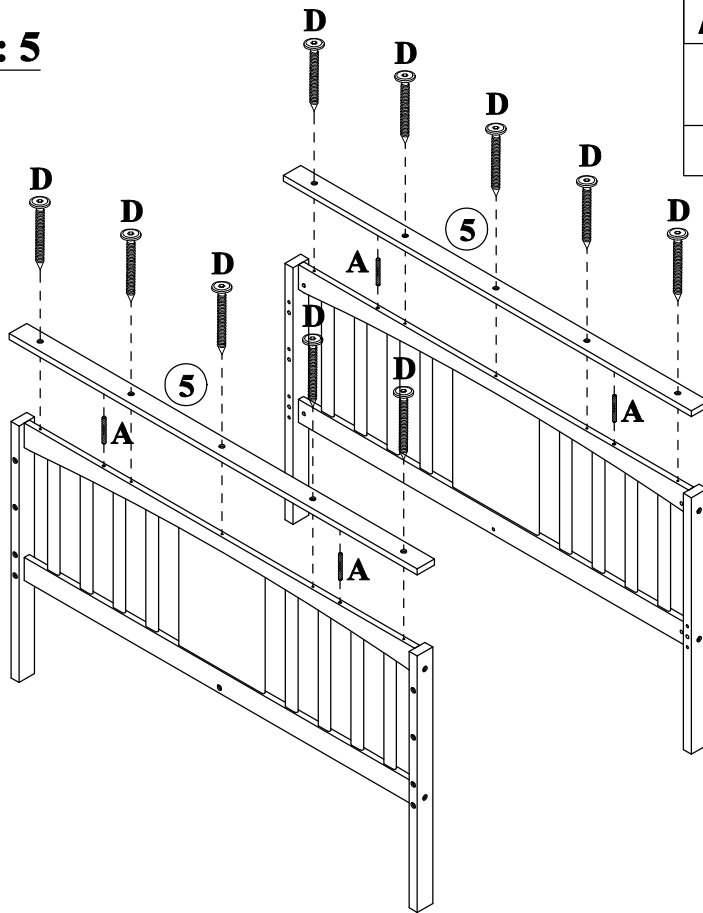

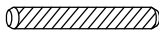

STEP: 5

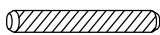

A	D
	
4PCS	10PCS

STEP: 6

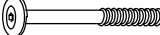
A	C	D	F	H
				
8PCS	3PCS	2PCS	4PCS	8PCS

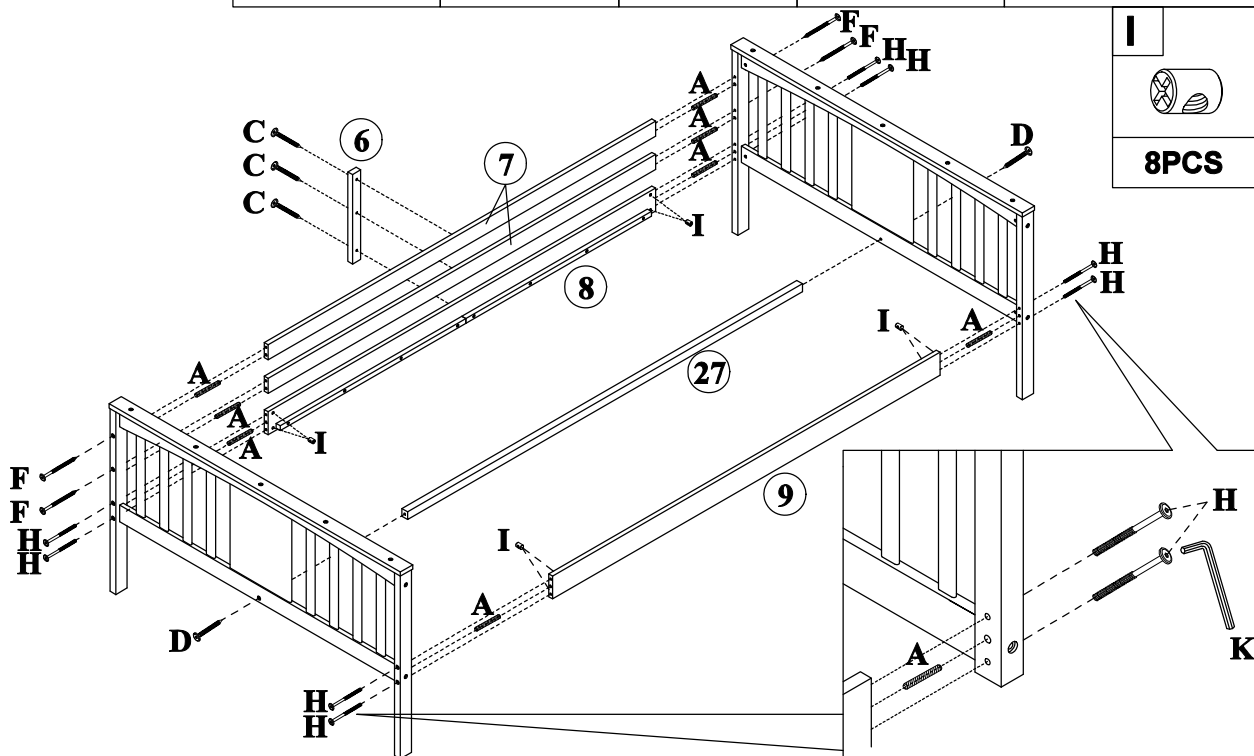

I

8PCS

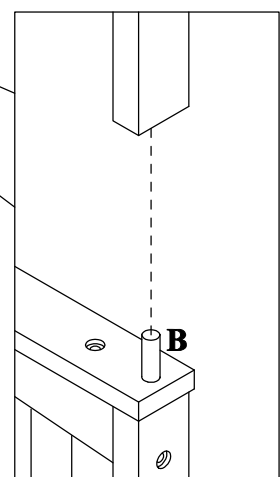
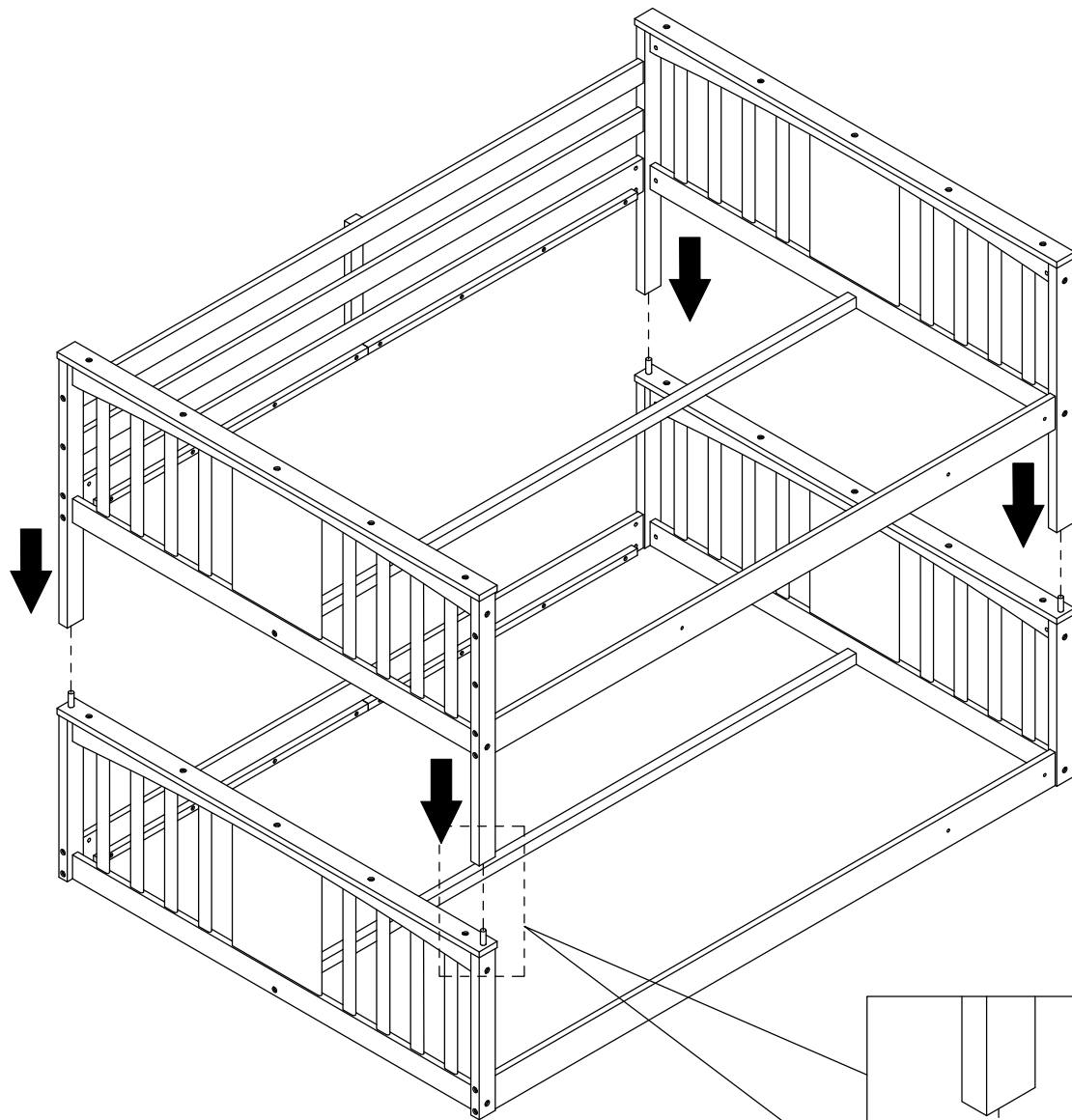
STEP: 7

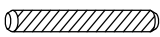

STEP: 8

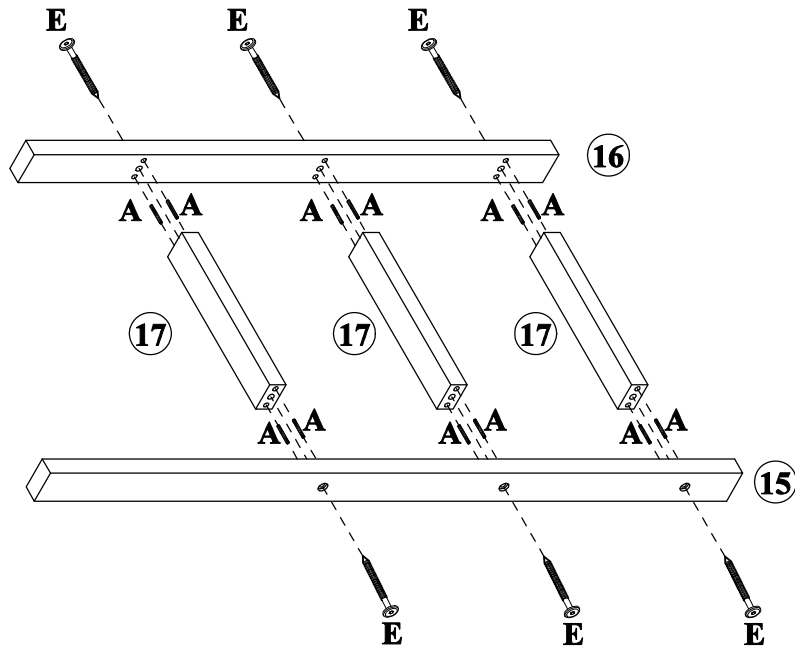
E	A
	
6PCS	12PCS



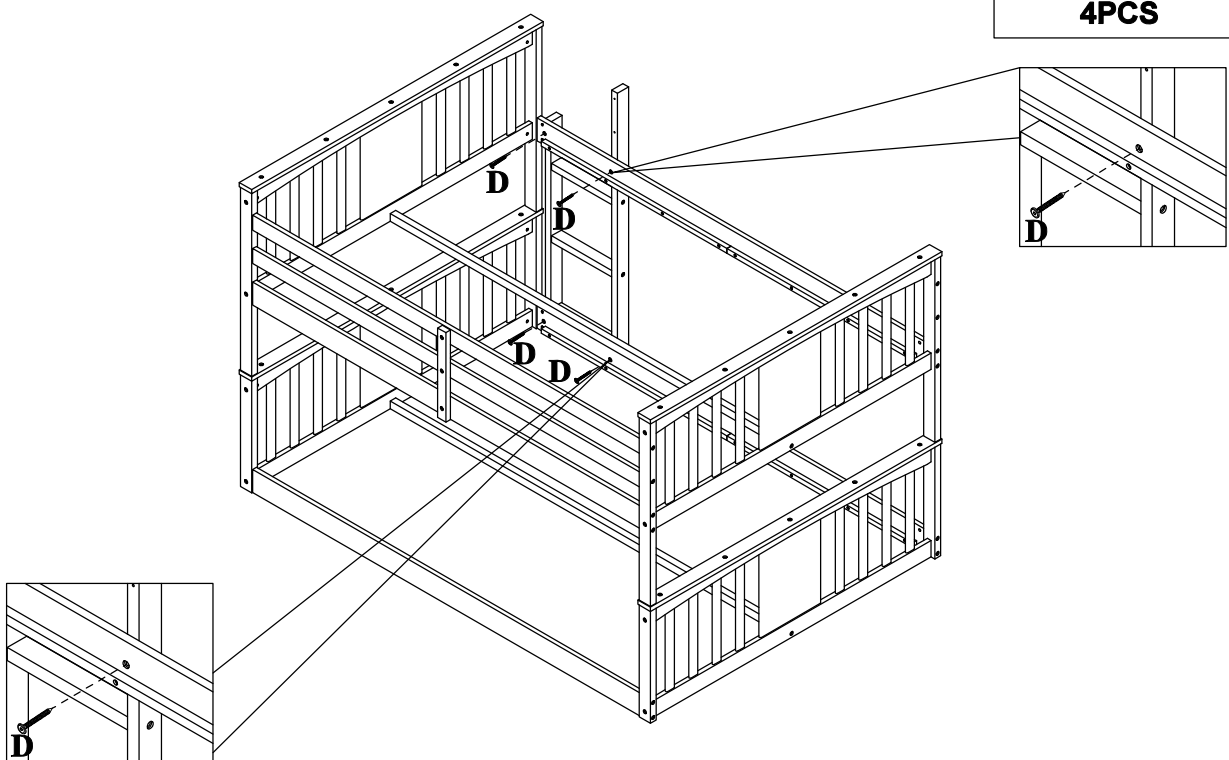

STEP: 9

D

4PCS

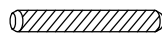

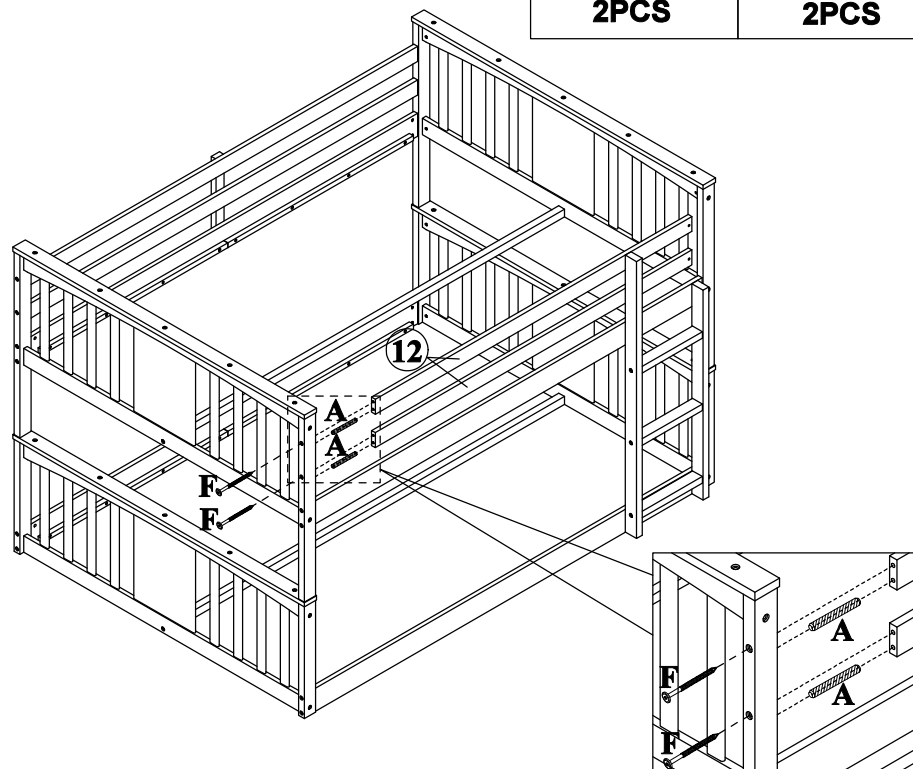

STEP: 10

A	F
	
2PCS	2PCS



STEP: 11

C	D
	
3PCS	2PCS

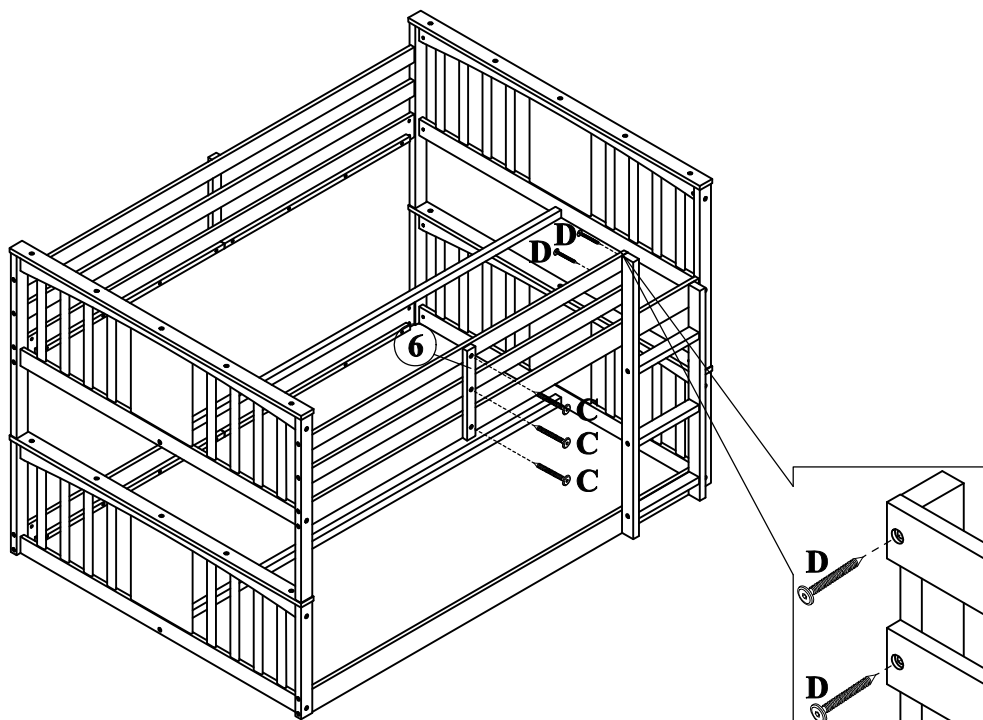

STEP: 12

J



63PCS

