

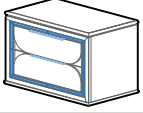

# ASSEMBLY INSTRUCTION FOR ACME FURNITURE





## MODEL#BD02318

Thank you for purchasing this quality product. Be sure to check all packing material carefully for small parts which may have loose inside the carton during shipment. Separate, identify and count all parts and metal hardware. Compare with all parts list to be sure all parts are present. If any part(s) are missing or damaged, please contact your local furniture dealer. For efficient and speedy service, please indicate the model number and code letter of part(s) needed.

\*\*\*Do not fully tighten screw until fully assembled\*\*\*

COMPONENT PARTS		
DESCRIPTION	PART NAME	Q'TY (PCS)
(A)	NIGHTSTAND 	1
(B)	BUN FOOT 	2
(C)	METAL LEG 	2

### HARDWARE REQUIRED

NO	NAME	PART	QTY
1	Allen key		1pc
2	JCBC 20mm		4pcs
3	M6 Spring washer		4pcs
4	M6 Flat washer		4pcs

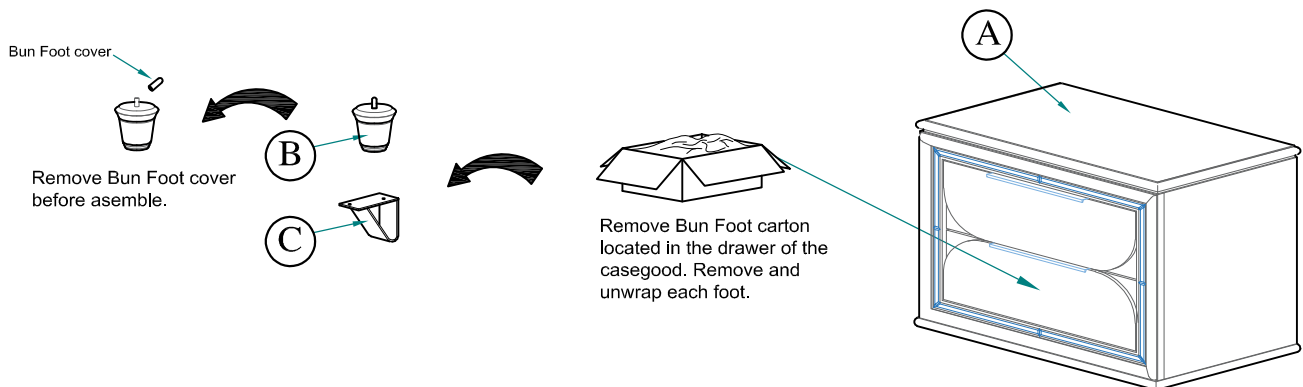

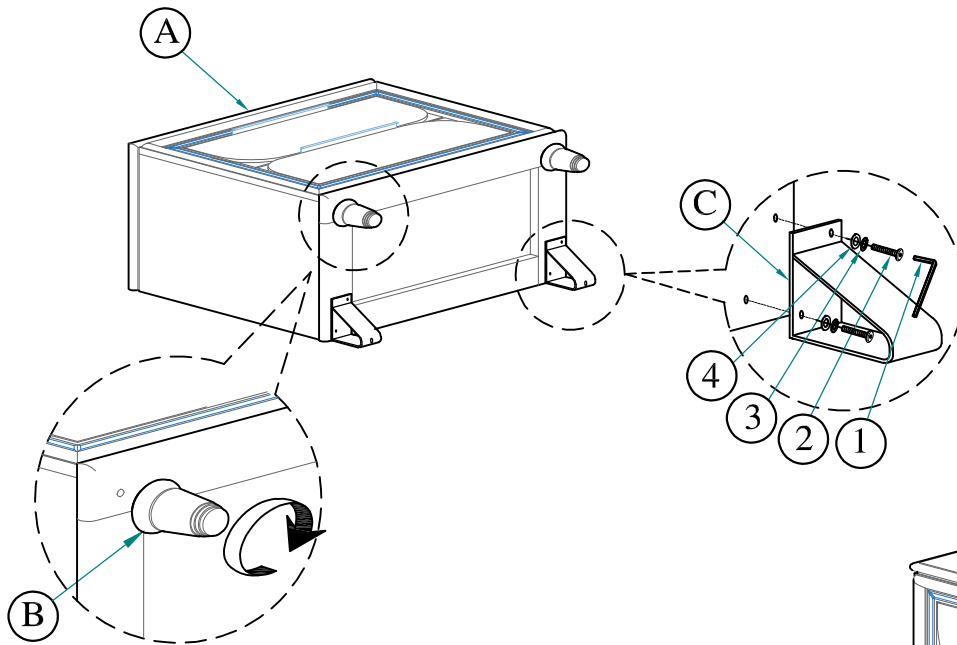



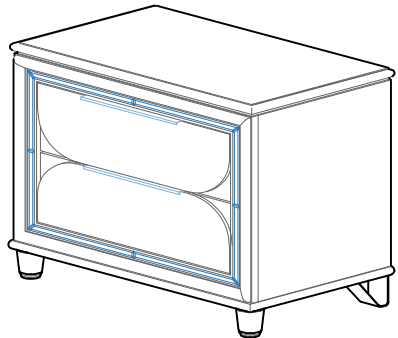

Step 2 : Secure the (C) Metal Leg to the bottom of (A) Nightstand tighten using (2) JCBC 20mm, (3) M6 Spring Washer & (4) M6 Flat Washer as a diagram shown.

Step 1: Secure the (B) Bun Foot to the bottom of (A) Nightstand as a diagram shown.



Assembly completed

**HARDWARE LIST (ANTI TIPPING)**

NO	NAME	PART	QTY
A	Bracket		2pcs
B	Tie Wrap		1pc
C	Long Screw		1pc
D	Short Screw		1pc

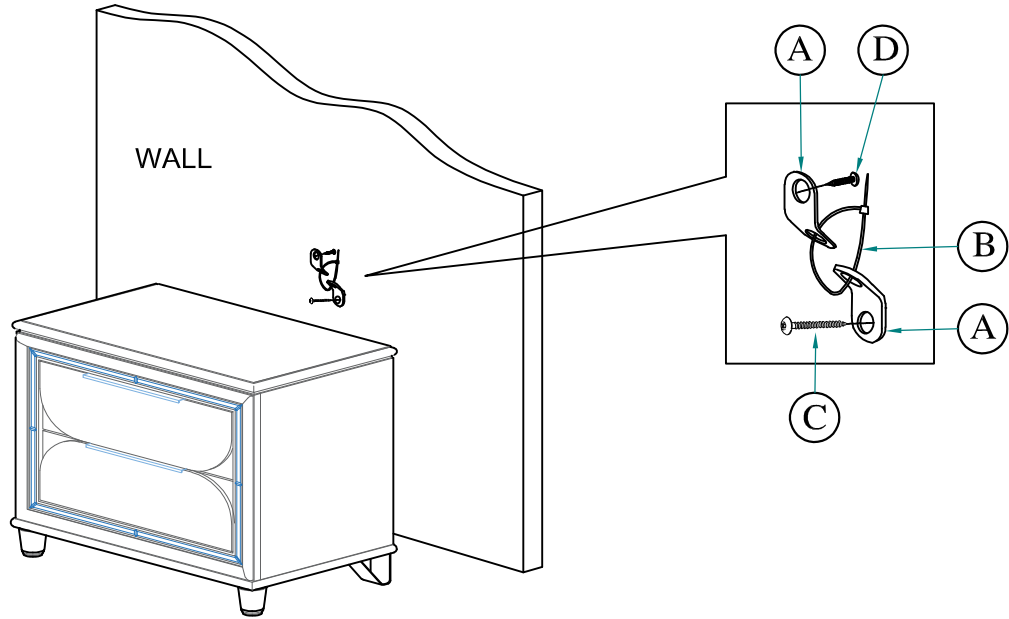

Assembly completed