

Assembly Instruction









Love seat

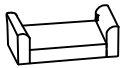

Legs and hardware are stored on the seat, please take them out for assembly.

Note: Do not use power tools for assembly. Power tools increase the risk of over tightening which lead to splitting or cracking the wood.

Component list

No	Drawing	Qty	Description
A		1	SEAT BASE
B		1	BACKREST
C		2	BACK CUSHIONS
D		2	SEAT CUSHIONS
E		2	PILLOWS (19*19")
F		4	WOODEN LEGS (177*177*45mm)
G		8	BOLTS 1/4*-20*45MM
H		1	ALLEN KEY 5/ 32mm

Step 1

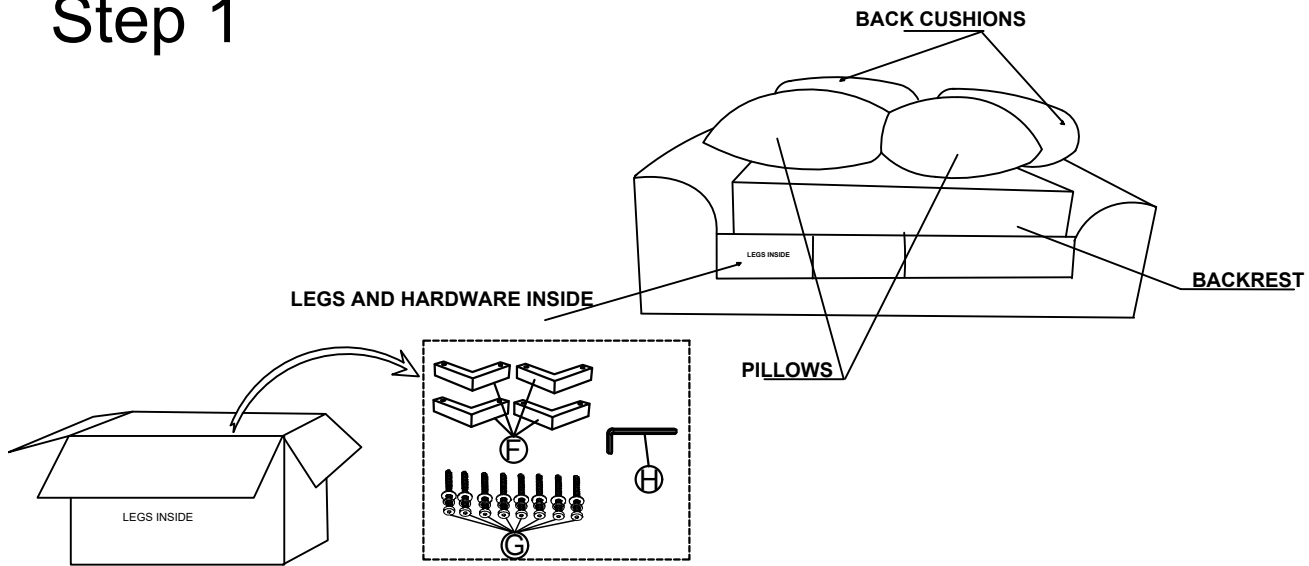

Step 2

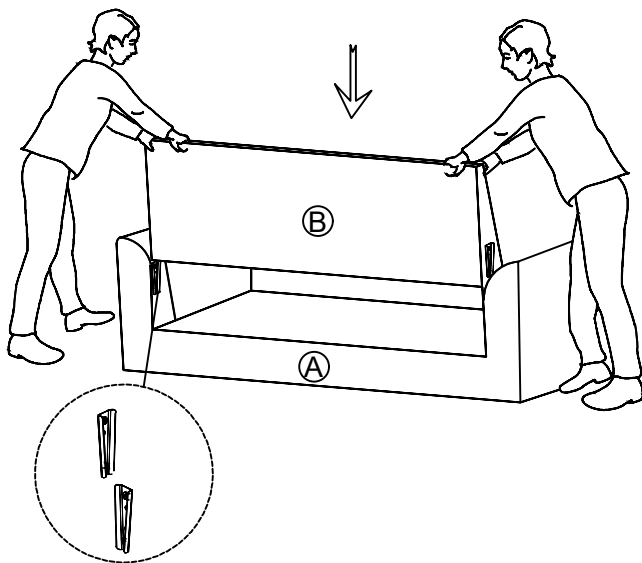

Step 3

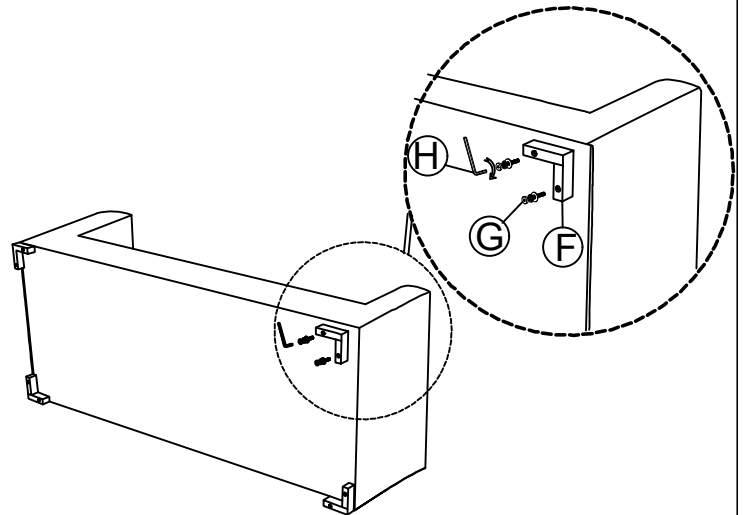

Step 4

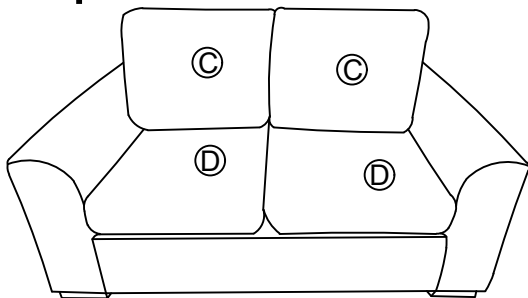

Completed

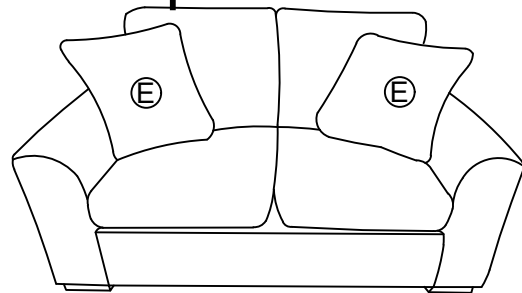

Care Instruction for Textured Fabric Furniture:

In order to maintain the original appearance of your textured fabric furniture, please follow below simple care procedures:

- Avoid exposing furniture directly to sunlight or heating and air conditioning outlets. Sunlight and/or exposure to heating and air conditioning outlets will fade/damage fabrics. Do not place your upholstered furniture too close to windows, radiators, or vents, and be sure to use windows, radiators, or vents.
- Vacuum or wipe with a soft cloth to remove dust.
- Hardware may loosen over time. Periodically check to make sure all connections are tight. Re-tighten if necessary.



For items use on wooden floor, hard surfaces or carpets, it is recommended to Install protective pads under all legs and supports to avoid/prevent from damages/scratches and discoloration.