

Assembly Instructions

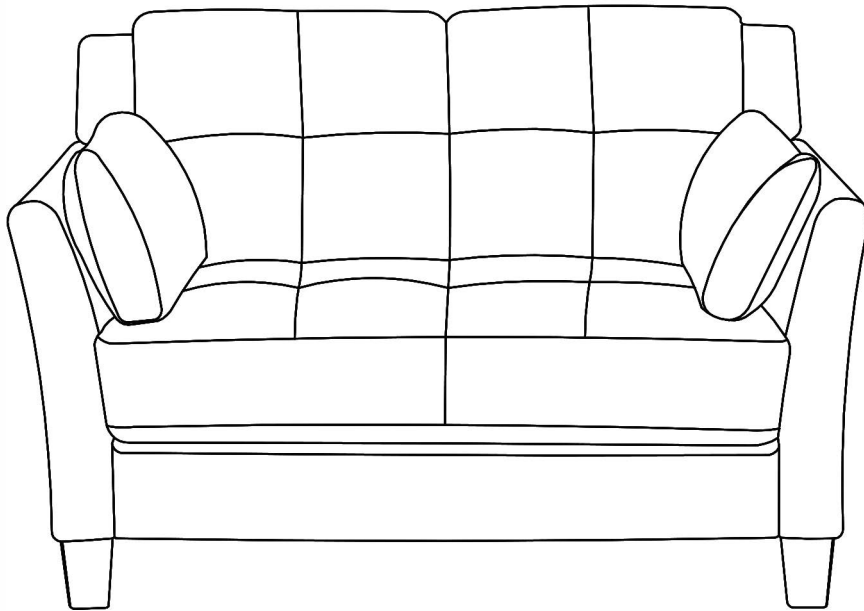

ASSEMBLY RATING

The Assembly Rating is a 5-point system that shows the degree of effort needed in assembling a specific product (with 1 being easy and 5 being difficult). For some products, two persons are recommended.

EASY  DIFFICULT

Tools Required For Assembly:

Wrench



(Included)



2 PERSONS RECOMMENDED

ASSEMBLY & CARE ADVICE

FOR YOUR FURNITURE TO LAST, CORRECT ASSEMBLY AND PROPER MAINTENANCE ARE NECESSARY. PLEASE FOLLOW THE INFORMATION PROVIDED BELOW TO FULLY ENJOY YOUR FURNITURE.

BASIC ASSEMBLY TECHNIQUES

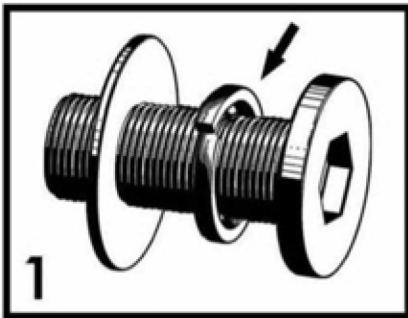

When lock or spring washer is used in an assembly, please make sure the lock or spring washer is placed between the larger flat washer and the head of the screw or bolt.



Position each part correctly and insert screws or bolts into their respective holes by hand tighten or using the proper hand tool. Only tighten when step is completed or when instructed to do so.



Use cardboard or carpet area when assembling furniture to prevent scratches. Make sure the furniture rests on a flat and level surface with each leg evenly touching the floor.

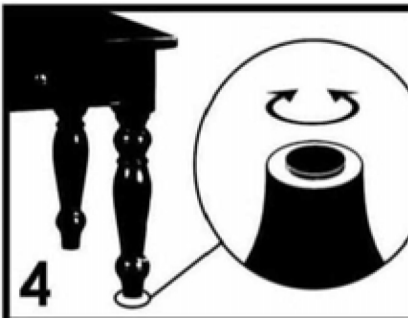

Some furniture comes with height adjustment knobs underneath each leg. To lower or to raise each leg, you need to turn clockwise or counterclockwise, respectively.

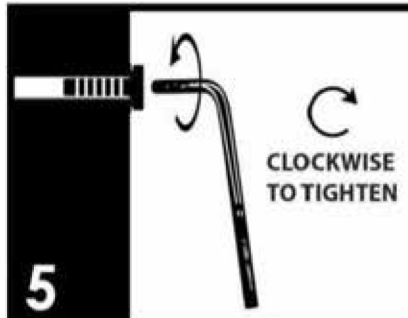

Make sure all parts are properly aligned, then use the appropriate hand tool to completely tighten the bolts or screws. Do not use power tools and do not overtighten.



Save the instructions and store the Allen wrench or any supplied tool for later maintenance. After two weeks, check and tighten any loose hardware and repeat again every six months thereafter.

IT IS THE USER'S RESPONSIBILITY TO MAINTAIN THE FURNITURE. THE HARDWARE MAY LOOSEN OVER TIME AND MAY CAUSE THE FURNITURE TO BE WOBBLY AND UNABLE TO SUPPORT ITS INTENDED WEIGHT CAPACITY. THIS MAY LEAD TO COLLAPSE AND MAY CAUSE SERIOUS INJURY.



FAILURE TO FOLLOW THE GUIDELINES ABOVE MAY RESULT IN INJURY AND/OR PROPERTY DAMAGE.



Before you begin, please read Page 2 of "Assembly and Care Advice".

And remember, do not tighten until each step is completed or instructed.

Parts List

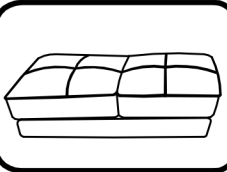

#1 x 1pc
Seat

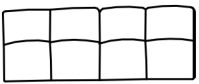

#2 x 1pc
Backrest

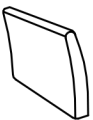

#3 x 2pcs
Arm



#4 x 2pcs
Ear



#5 x 2pcs
Pillow



#6 x 4pcs
Leg

Hardware List



#A x 14pcs
Threaded rod (M8*95mm)

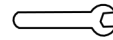

#B x 1pc
Wrench



#C x 14pcs
Hex Nut



#D x 14pcs
Flat washer



#E x 4pcs
Gasket



#A x 4pcs
#C x 4pcs
#D x 4pcs

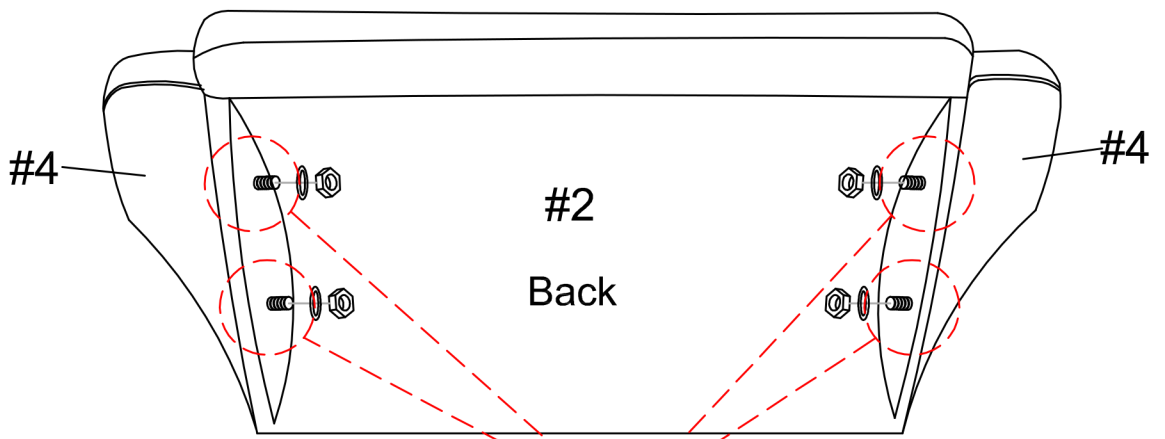

- I. Insert 2 bolts (#A) into each ear (#4), turn right to tighten.
- II. Facing the back, align the ears (#4) to the pre-drilled holes along the sides of the backrest (#2). Insert the ends of the bolts (#A).
- III. Onto each bolt end insert a flat washer (#D) and then a hex nut (#C). Secure each by using the wrench (#B).

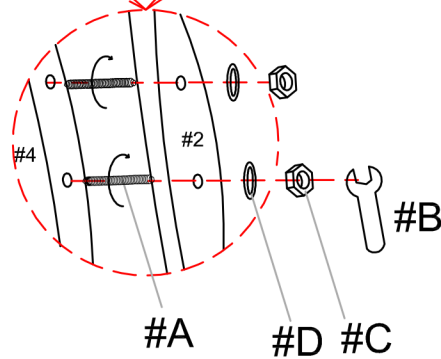

#A x 2pcs
#C x 2pcs
#D x 2pcs

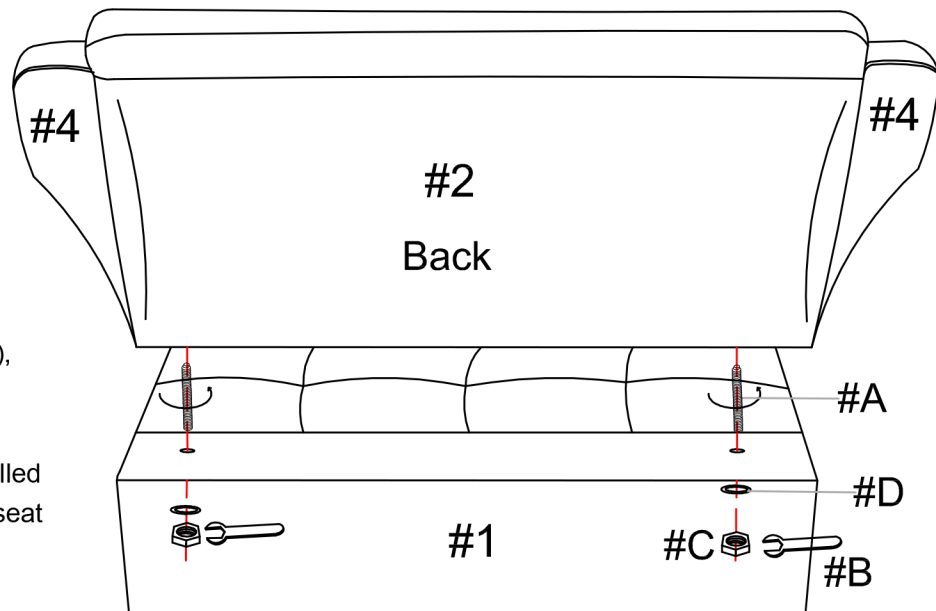

- I. Insert 2 bolts (#A) into the bottom of the backrest (#2), turn right to tighten.
- II. Facing the back, align the backrest (#2) to the pre-drilled holes along the top of the seat (#1). Insert the ends of the bolts (#A).
- III. Onto each bolt end insert a flat washer (#D) and then a hex nut (#C). Secure each from below by using the wrench (#B).



#A x 8pcs
 #C x 6pcs
 #D x 6pcs

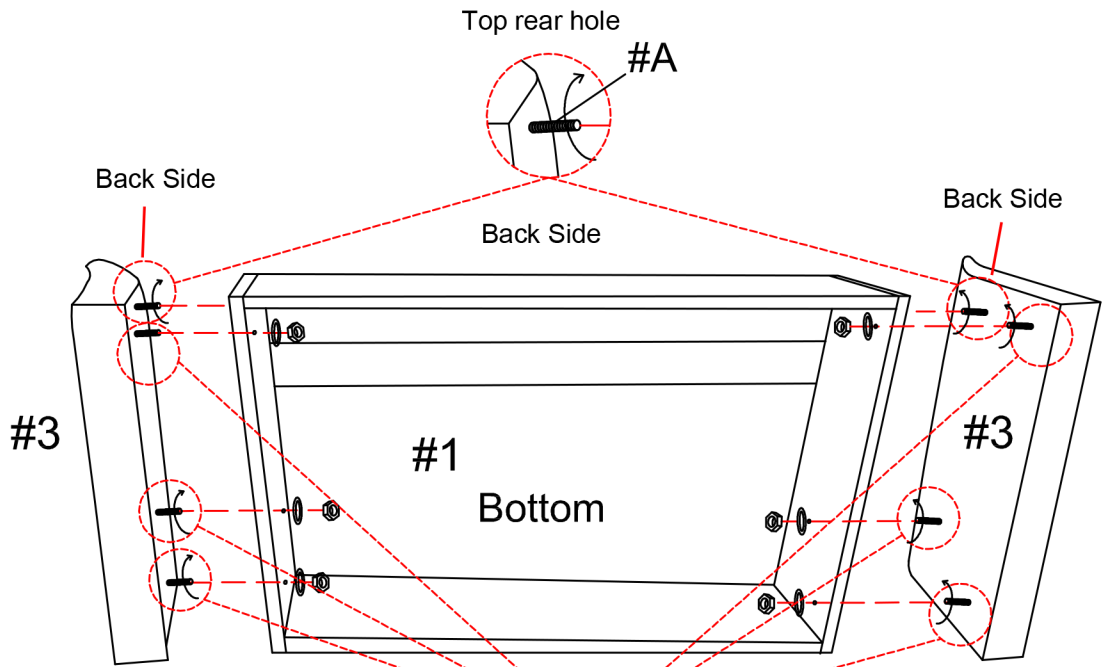

- I. Insert 1 bolt (#A) into the pre-drilled hole on the top back of each arm (#3). Insert 3 bolts (#A) into the remaining holes on each arm (#3), turn right to tighten.
- II. Insert the other ends of the bolts on the arms (#3) into the pre-drilled holes along the sides of the seat (#1).
- III. From within the seat (#1) apply a flat washer (#D) and then a hex nut (#C). Secure each by using the wrench (#B).

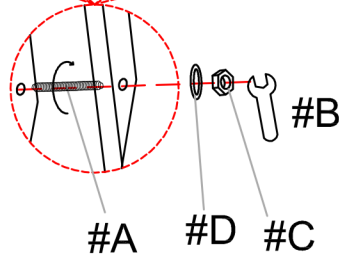

#C x 2pcs
 #D x 2pcs

Apply the top assembly onto the seat (#1) and insert onto the bolts (#A) on each side. Once inserted, apply a flat washer (#D) then a hex nut (#C) and secure using the wrench (#B).

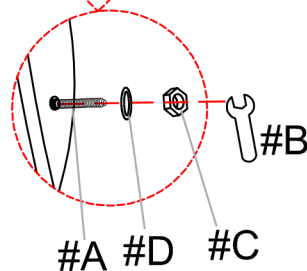
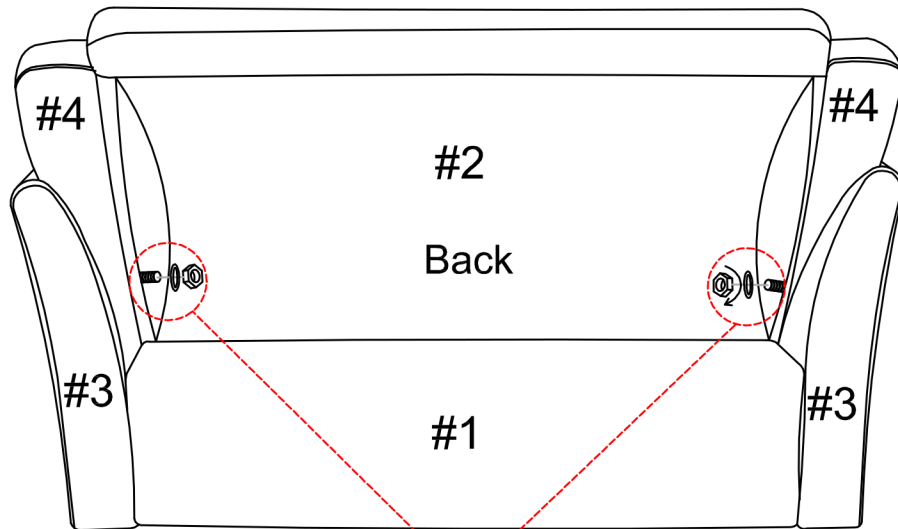



#E x 4pcs

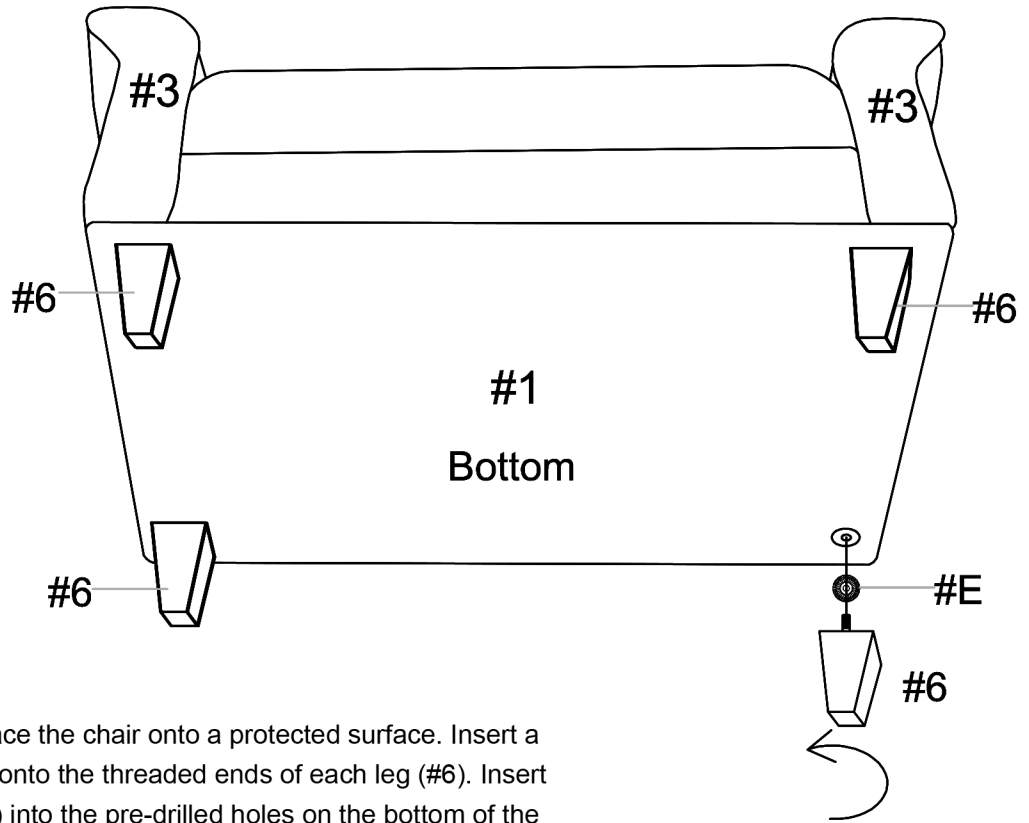

Carefully place the chair onto a protected surface. Insert a gasket (#E) onto the threaded ends of each leg (#6). Insert the legs (#6) into the pre-drilled holes on the bottom of the seat and turn right to tighten.



Place pillows. Make sure all parts are firmly secured.

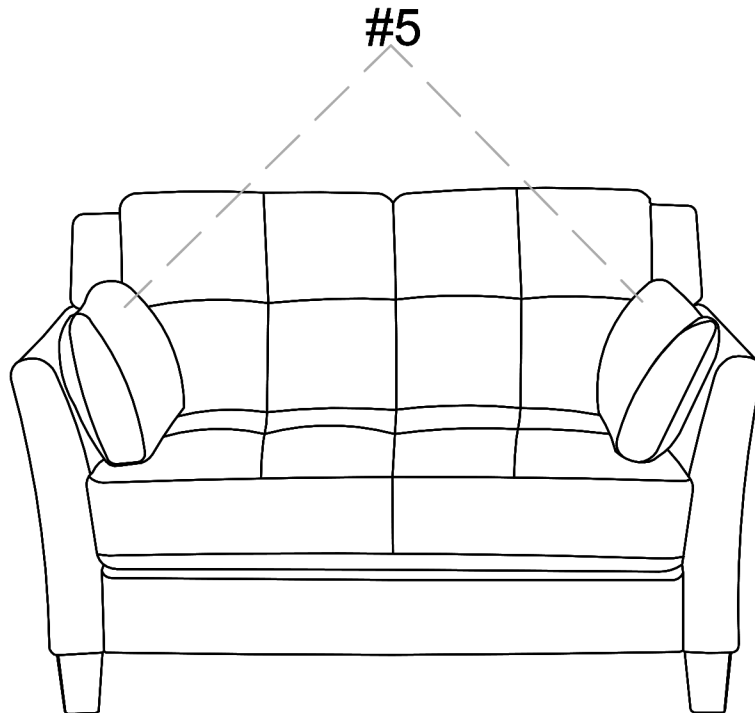

ASSEMBLY IS COMPLETED