

# ASSEMBLY INSTRUCTIONS

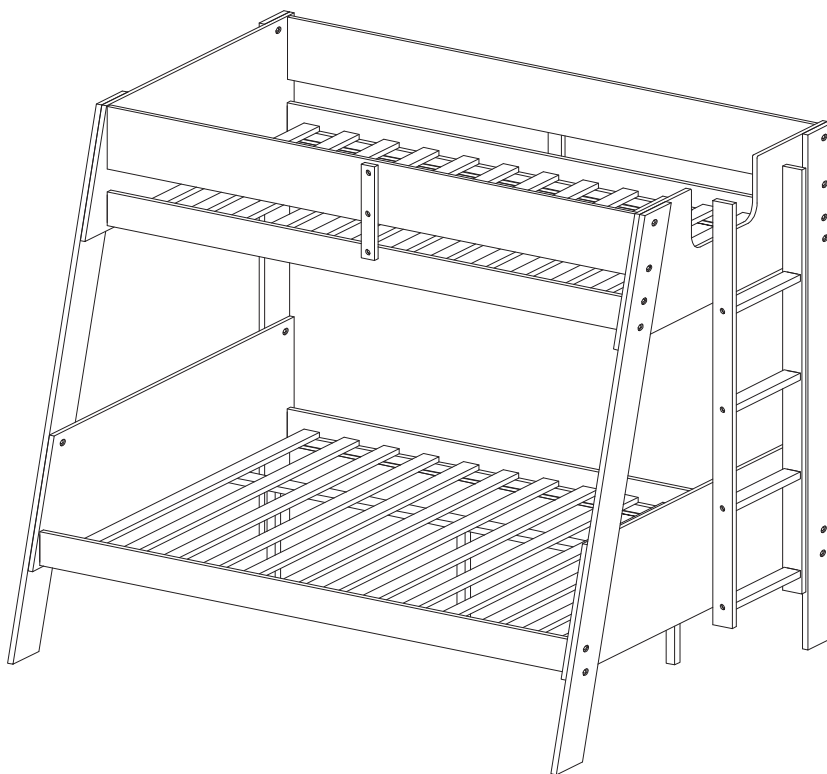

## TOOLS REQUIRED



Allen Wrench

(Included)



Phillips  
Screwdriver

(Not Included)



2 - People  
Recommended

## ASSEMBLY RATING



EASY —————> DIFFICULT

The Assembly Rating is a 5-point system showing the level of effort needed to assemble a specific product.



## CHECK BEFORE STARTING



### Are you missing anything?

Double-check all parts, hardware and accessories listed on Page 6 are accounted for.



### Check out our Quick Tips!

We recommend reviewing the pre-assembly handouts. Even experts need a refresher now and then!



### Should we send any replacements?

Are there any irregularities or flaws in the parts? We can send replacements!



### Prep Time!

Please review the assembly instructions and all diagrams prior to assembling. Set up your workspace by laying the parts and hardware out separately, then begin!

# PRE ASSEMBLY INTRODUCTION

We understand building ready-to-assemble furniture can be a challenging experience for some. To help avoid confusion, we have provided some helpful tips that may speed up the process.



## Teamwork

ALWAYS have at least two people to help with transporting and assembling the product to avoid potential injury and/or damage.



## Suitable Location

Assembling near the area of the intended location is highly recommended.



## Sufficient Space

Make sure you have enough space to move around during the assembly.



## Avoid Scratches

Use cardboard, blankets or a carpeted area while assembling furniture to prevent scratches.



## Flat Surface

Make sure the furniture rests on a flat and level surface with each leg evenly touching the floor.

# ASSEMBLY AND CARE ADVICE



**FAILURE TO FOLLOW THE GUIDELINES BELOW MAY RESULT IN INJURY AND/OR PROPERTY DAMAGE.**



Position each part correctly and insert screws or bolts into their respective holes.

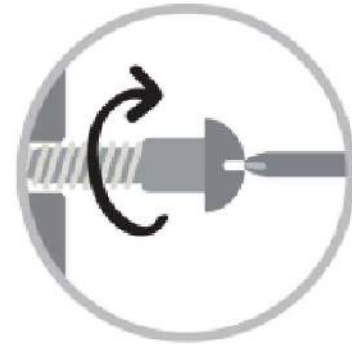

Turn clockwise to tighten and only tighten when step is completed or when instructed to do so.



Use the appropriate hand tools or power tools for assembly. Select steps, such as tightening screws and/or bolts, may require hand tools to avoid causing damage during assembly.



Save the instructions and store any supplied tools for later maintenance.

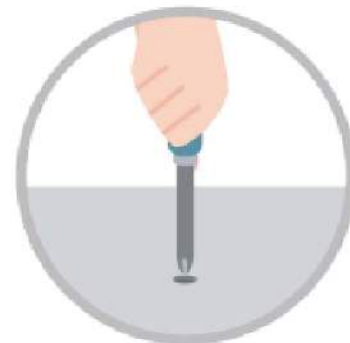

After two weeks, check and tighten any loose hardware and repeat again every six months thereafter.

**IT IS THE USER'S RESPONSIBILITY TO MAINTAIN THE FURNITURE. THE HARDWARE MAY LOOSEN OVER TIME AND MAY CAUSE THE FURNITURE TO BE WOBBLY AND UNABLE TO SUPPORT ITS INTENDED WEIGHT CAPACITY. THIS MAY LEAD TO COLLAPSE AND MAY CAUSE SERIOUS INJURY.**

# BUNK BED

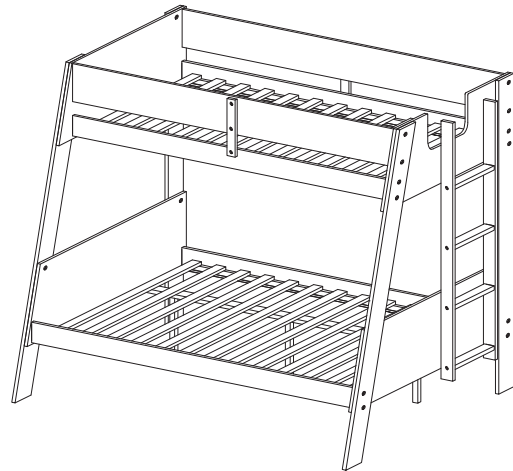
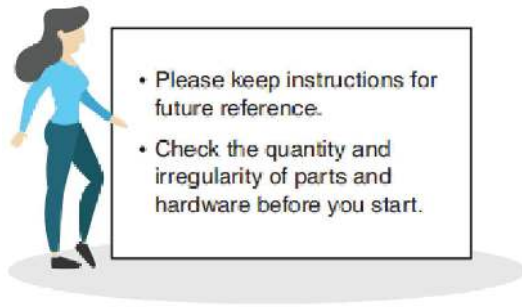

## PARTS

1



1pc  
Front Leg (L)

5

2



1pc  
Front Leg (R)

6

3



1pc  
Back Leg (R)

7

4



1pc  
Back Leg (L)

8

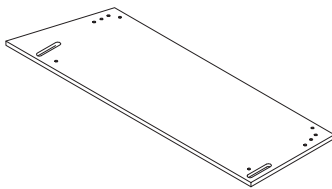

1pc  
Upper Board (L)

9

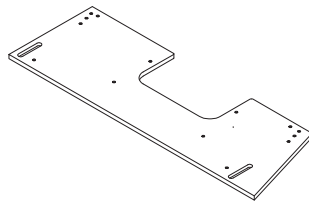

1pc  
Upper Board (R)

10

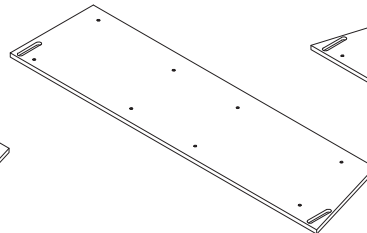

1pc  
Lower Board (R)

11

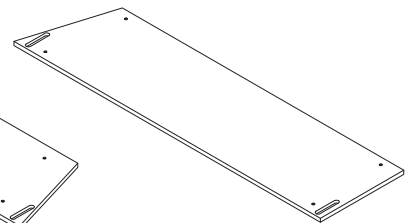

1pc  
Lower Board (L)

12

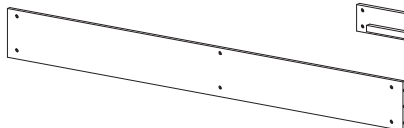

2pcs  
Panel Top

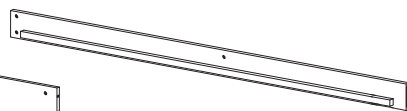

2pcs  
Side Rail Top



2pcs  
Vertical Guard Rail Support

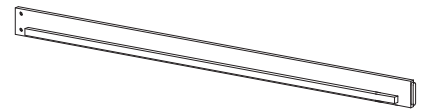

2pcs  
Side Rail Bottom

**PARTS**

13

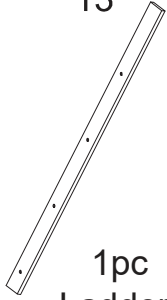

1pc  
Ladder (L)

14

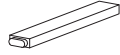

4pcs  
Step Ladder

15

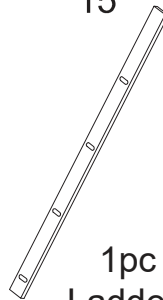

1pc  
Ladder (R)

16

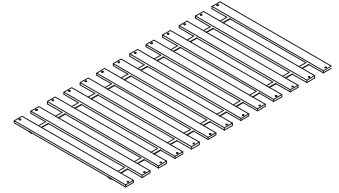

1set  
Upper Slat (13pcs)

17

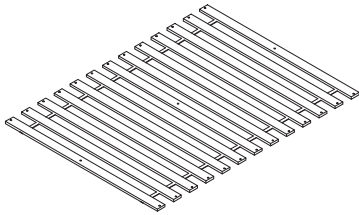

1set  
Lower Slat (13pcs)

18



3pcs  
Center Support Leg

19

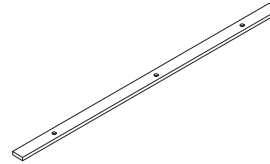

1pc  
Center Support

**HARDWARE**

A

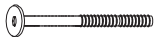

Bolt  $\text{\O}1/4 \times 3-3/8$ "(D15)  
24pcs

B



Bolt  $\text{\O}1/4 \times 20$   
24pcs

C



Bolt  $\text{\O}1/4 \times 1-5/8$ "(D13)  
8pcs

D



Bolt  $\text{\O}1/4 \times 1-1/8$ "(D15)  
22pcs

E



Wood Screw  $1/4 \times 2$ "(D13)  
11pcs

F

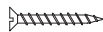

Screw  $4 \times 30$ mm  
55pcs

G













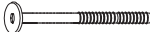





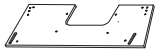
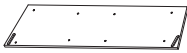

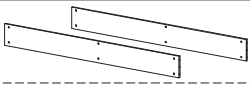
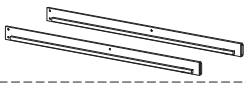

$\text{\O}10 \times 50$ mm  
4pcs

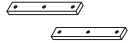
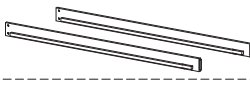
K

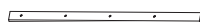

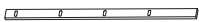
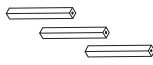
Allen Key 4mm  
1pc

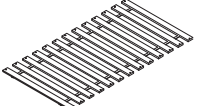
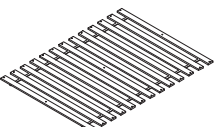
Carton	Disignation		Part	Hardware
01	Front Leg (L)	1		FM-BK202WH-1
	Front Leg (R)	2		 A x 24pcs
	Back Leg (R)	3		 B x 24pcs
	Back Leg (L)	4		 C x 8pcs
	Upper Board (L)	5		 D x 22pcs
	Upper Board (R)	6		
	Lower Board (R)	7		 E x 11pcs
	Lower Board (L)	8		 F x 55pcs
02	Panel Top	9		
	Side Rail Top	10		 G x 4pcs
	Vertical Guard Rail Support	11		
	Side Rail Bottom	12		 K x 1pc
	Ladder (L)	13		
	Step Ladder	14		
	Ladder (R)	15		
	Center Support Leg	18		
	Center Support	19		
03	Upper Slat (13pcs)	16		
	Lower Slat (13pcs)	17		

# ASSEMBLY INSTRUCTIONS

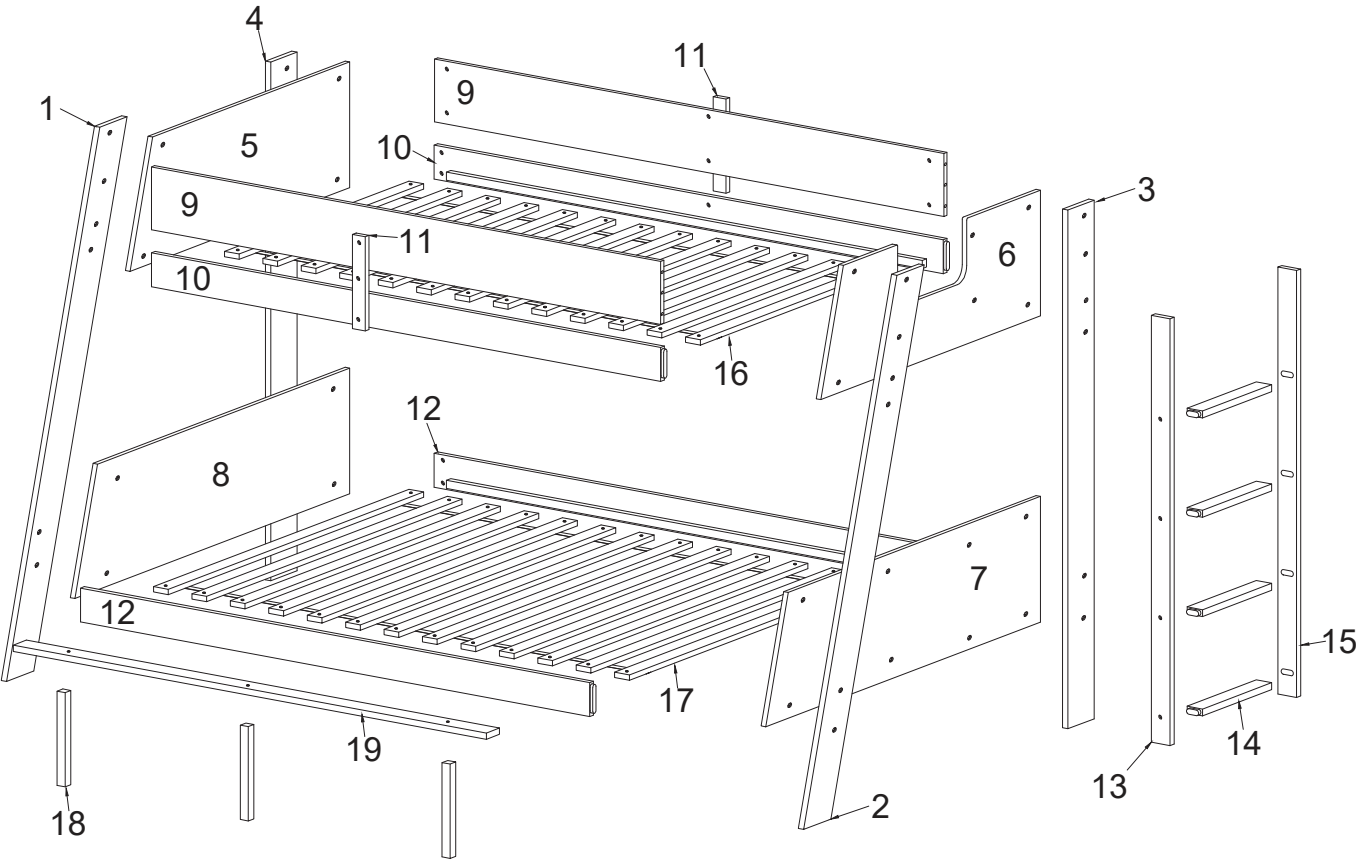

# ASSEMBLY INSTRUCTIONS

1

- Part #1 x1pc
- Part #2 x1pc
- Part #3 x1pc
- Part #4 x1pc
- Part #5 x1pc
- Part #6 x1pc
- Part #7 x1pc
- Part #8 x1pc
- Hardware #D x16pcs
- Hardware #G x4pcs
- Hardware #K x1pc

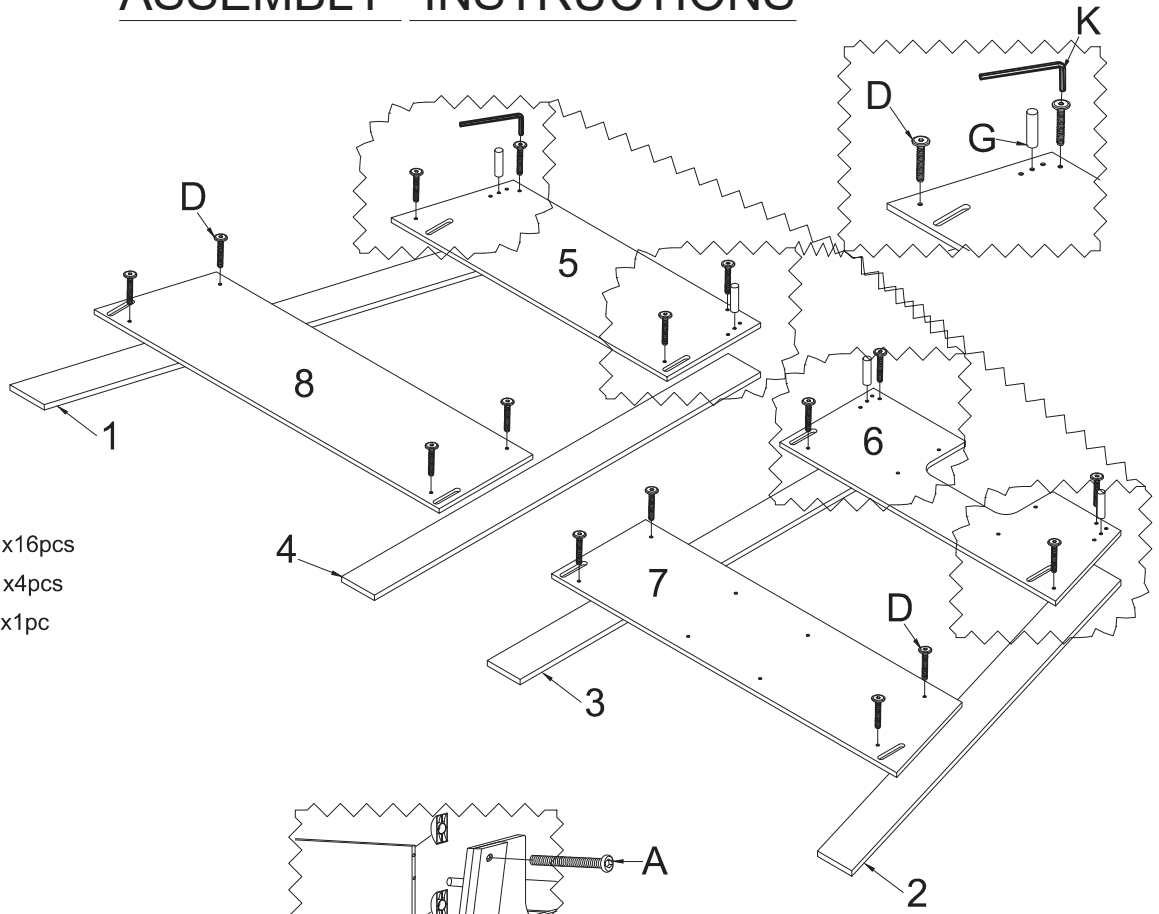

2

- Part #9 x2pcs
- Part #10 x2pcs
- Part #12 x2pcs
- Hardware #A x24pcs
- Hardware #B x24pcs
- Hardware #K x1pc

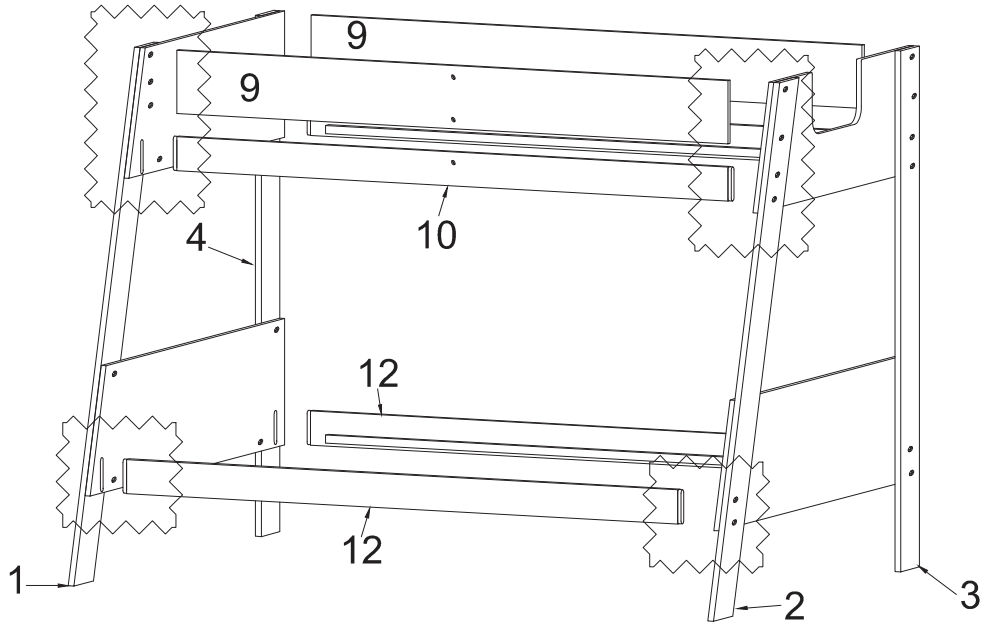
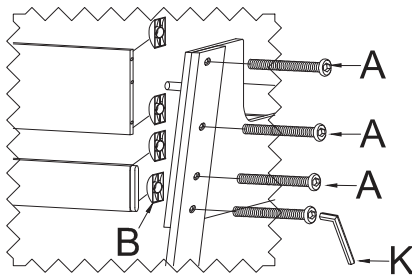

# ASSEMBLY INSTRUCTIONS

## 3

- Part #13 x1pc
- Part #14 x4pcs
- Part #15 x1pc
- Hardware #E x8pcs
- Hardware #K x1pc

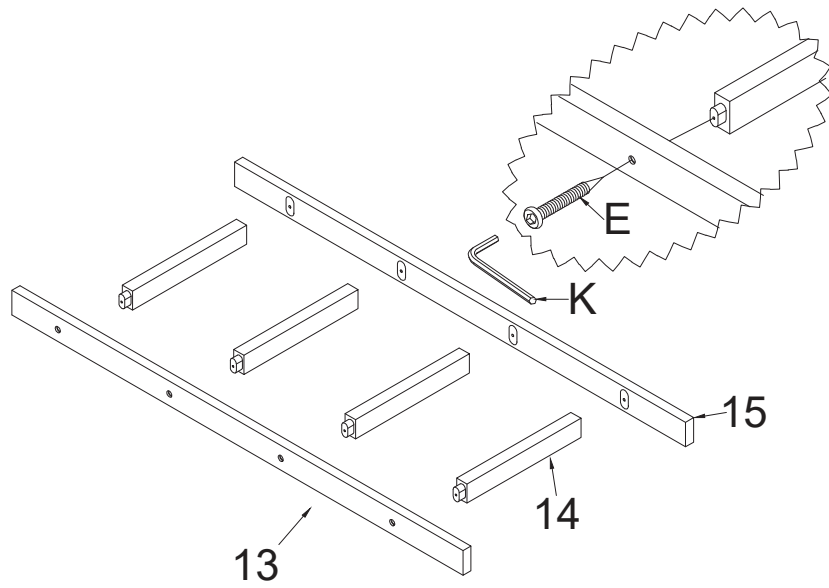

## 4

- Part #11 x2pcs
- Hardware #C x8pcs
- Hardware #D x6pcs
- Hardware #K x1pc

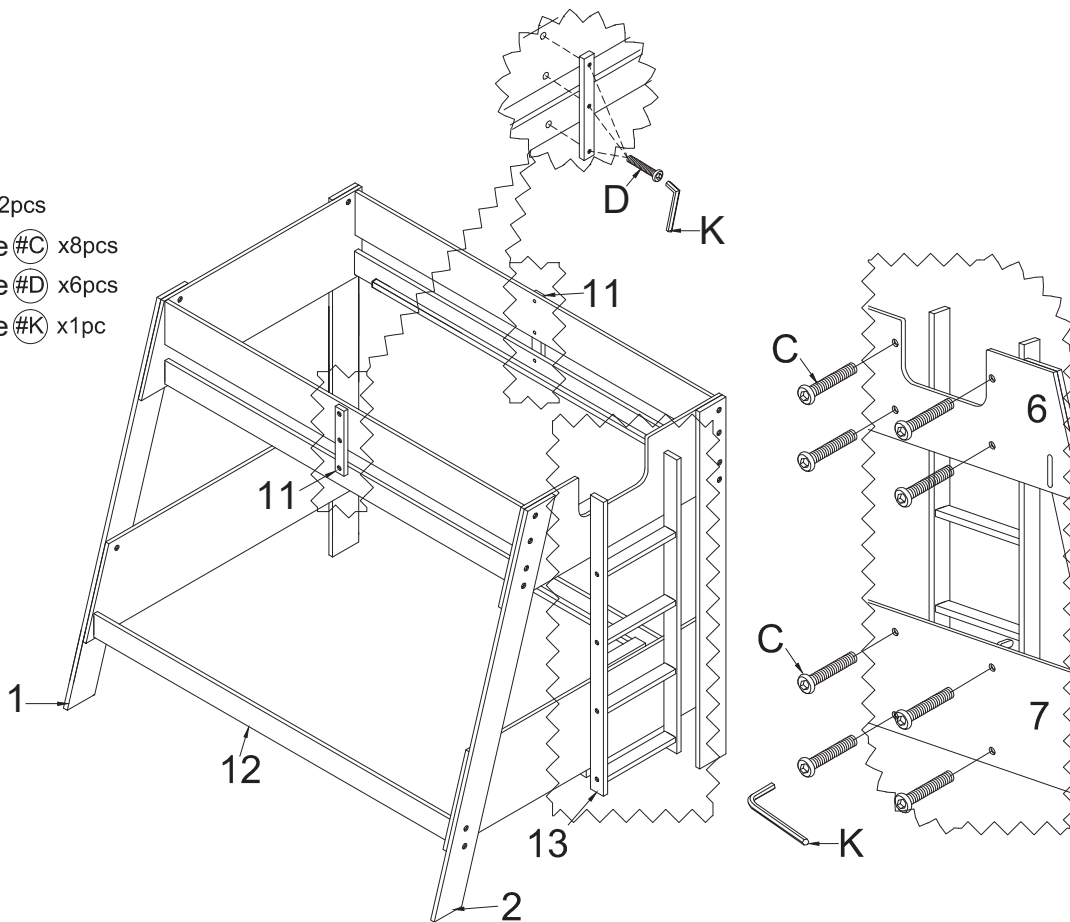

# ASSEMBLY INSTRUCTIONS

## 5

- Part #16 x1set
- Part #17 x1set
- Hardware #F x52pcs

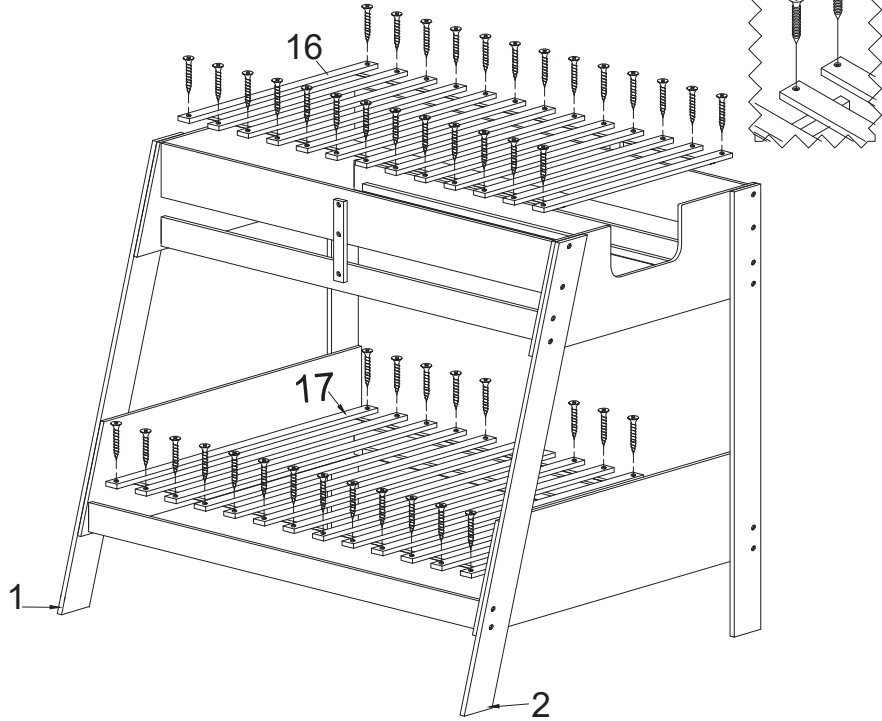

## 6

- Part #18 x3pcs
- Part #19 x1pc
- Hardware #E x3pcs
- Hardware #F x3pcs
- Hardware #K x1pc

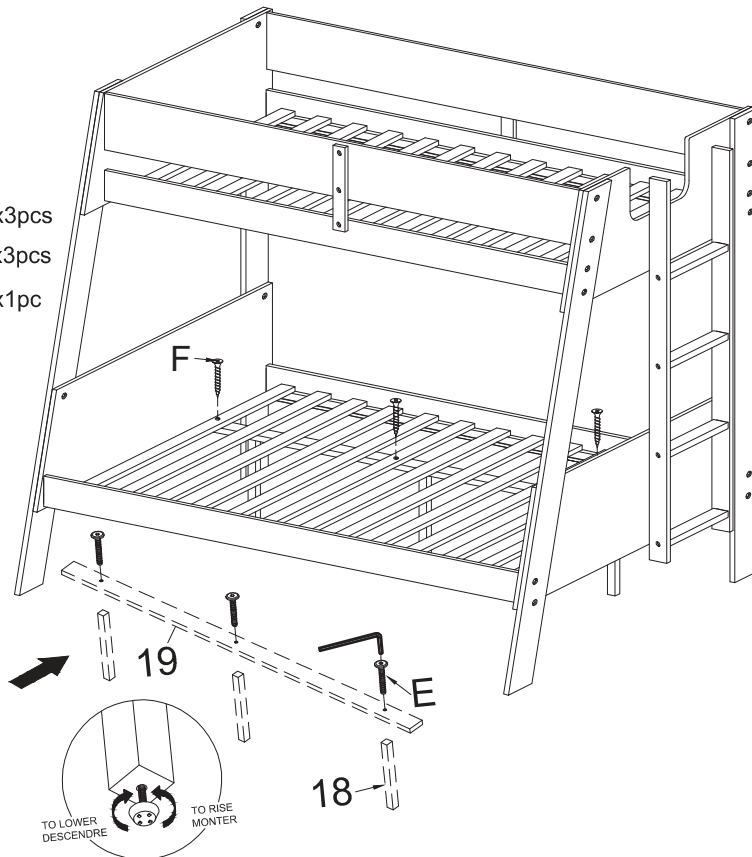

### ASSEMBLY COMPLETED



Please ensure the furniture rests on an even and flat surface. If the product wobbles or feels loose, double-check all bolts and/or screws are properly tightened and secured.



#### Keep this handy!

Please retain this instruction manual and any order-related information for future reference.



#### Lift, don't drag!

To avoid damage to product please **always LIFT** the product when transporting or adjusting the placement.

This product is intended for RESIDENTIAL USE ONLY and not for commercial use.

## Safety Warnings for Bunk Beds

1. Read and follow the information on the WARNING labels shown on the end structure of the upper bunk and on the carton.
2. Do not remove warning labels from the bed.
3. Keep these instructions for future use.
4. **IMPORTANT:** Must use Bunkie mattress or Bunkie board. The proper sizes for the UPPER/LOWER TWIN-SIZE Bunkie mattress or Bunkie board should be 74" - 75" long and 37 ½" - 38 ½" wide with no more than 6" thickness and for the UPPER/LOWER FULL -SIZE should be 74"-75" long and 53" - 54" wide with no more than 6" thickness.
5. Surface of mattress must be at least 5 inches (127 mm) BELOW the upper edge of the guardrails.
6. The MAXIMUM weight capacity for the upper bunk is not to exceed 150 lbs.
7. Do not allow children under 6 years of age to use the upper bunk.
8. Periodically check and ensure that the guardrails, ladder, handle and other components are in their proper position, free from damage, and that all connectors are tightened and secured.
9. **DO NOT** allow horseplay, rough playing, or jumping on the beds and do not allow playing or hiding under the beds.
10. Always use the ladder for entering or leaving the upper bunk.
11. Do not use substitute parts. Contact the manufacturer or dealer for replacement parts.
12. Use of a nightlight may provide added safety precaution for a person using the upper bunk.
13. Always use the guardrails on both sides of the upper bunk.
14. If the bunk bed will be placed next to a wall, the guardrail that runs the full length of the bed should be placed against the wall to prevent entrapment between the bed and the wall.
15. The use of water or sleep flotation mattresses is prohibited.
16. No more than one person is allowed on the upper bunk at all times.
17. Always use the recommended size mattresses or mattress supports, or both, to help prevent the like likelihood of entrapment or falls.



Objects such as, but not limited to, hanger, hooks, belts, bag, rope strings, etc. should not be hanged or used on or around the bunk bed.