

**Service • Assistenza • Dienstverlening • Serwis
Servis • Szerviz • Сервисная служба**

Name • Nom • Nome • Naam • Nazwa • Jméno • Názov • Név • Denumire • İsim • Название	Bradford
Nr. • No. • N° • Номер • Č • Sz	
Typ • Type • Тип • Típus • Тиро • Тип	
	

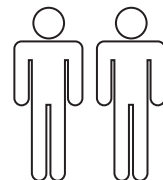

- (D)** Montageanleitung
- (FR)** Notice de montage
- (NL)** Handleiding voor de montage
- (CZ)** Montážní návod
- (HU)** Szerelési útmutató
- (TR)** Montaj talimati
- (GB)** Assembly instructions
- (IT)** Istruzioni di montaggio
- (PL)** Instrukcja montażu
- (SK)** Návod na montáž
- (RO)** Instrucțiuni de montaj
- (RU)** Инструкция по монтажу

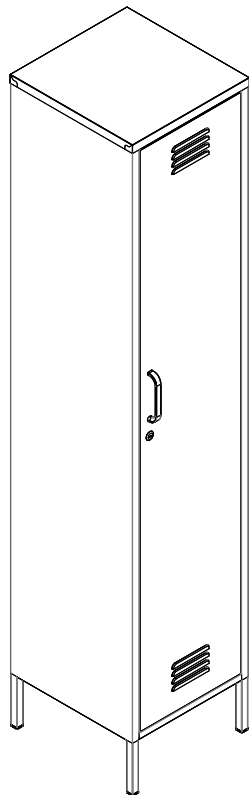
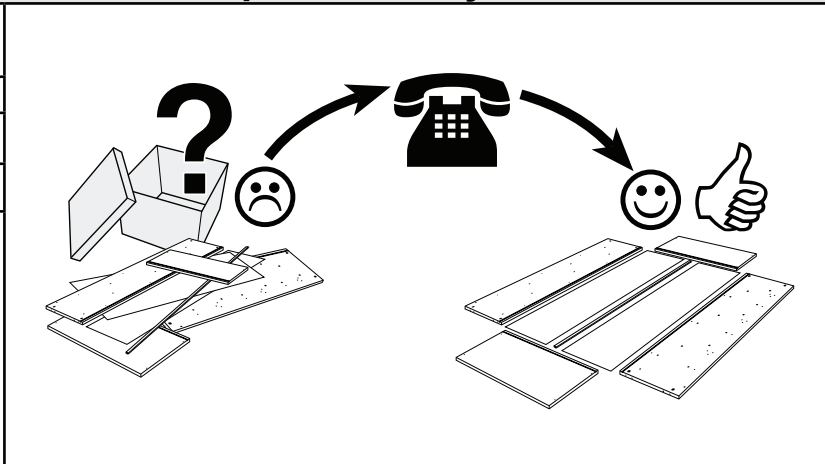
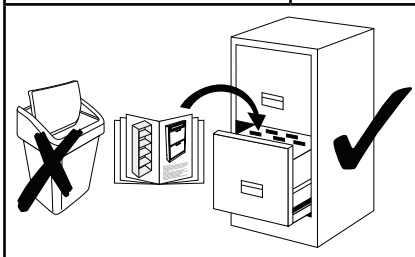
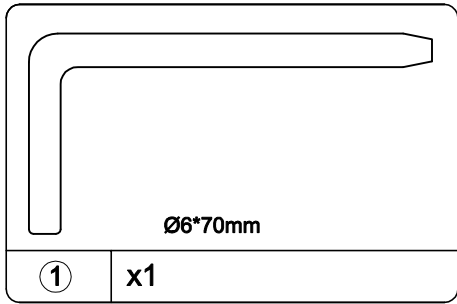

TM0001

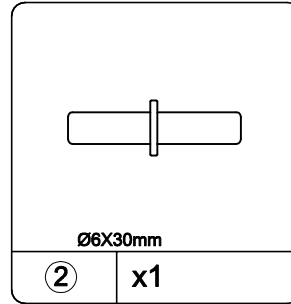

TM0002

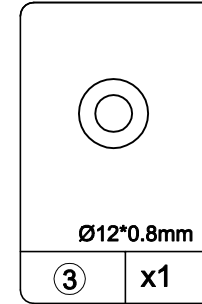

TM0003

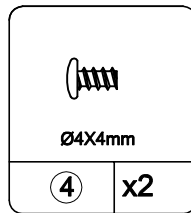

TM0004

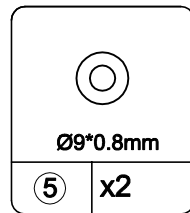

TM0005

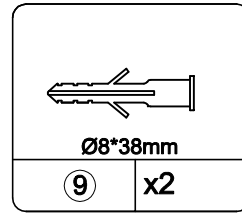

TM0009

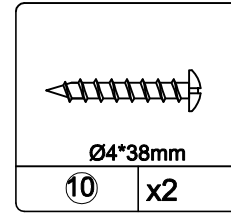

TM0010

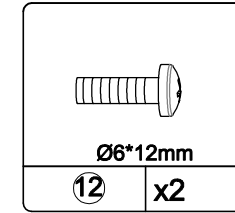

TM0008

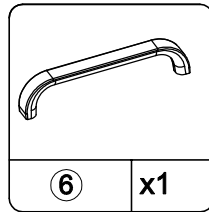

TM0015

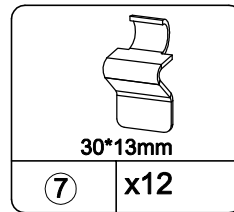

TM0007

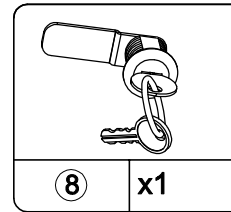

TM0008

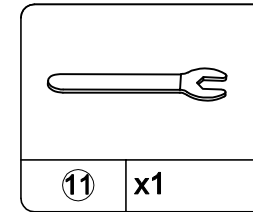

TM0011

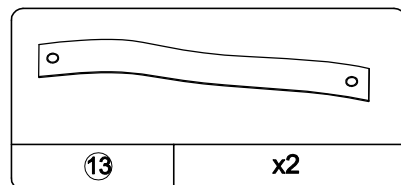

TM0011

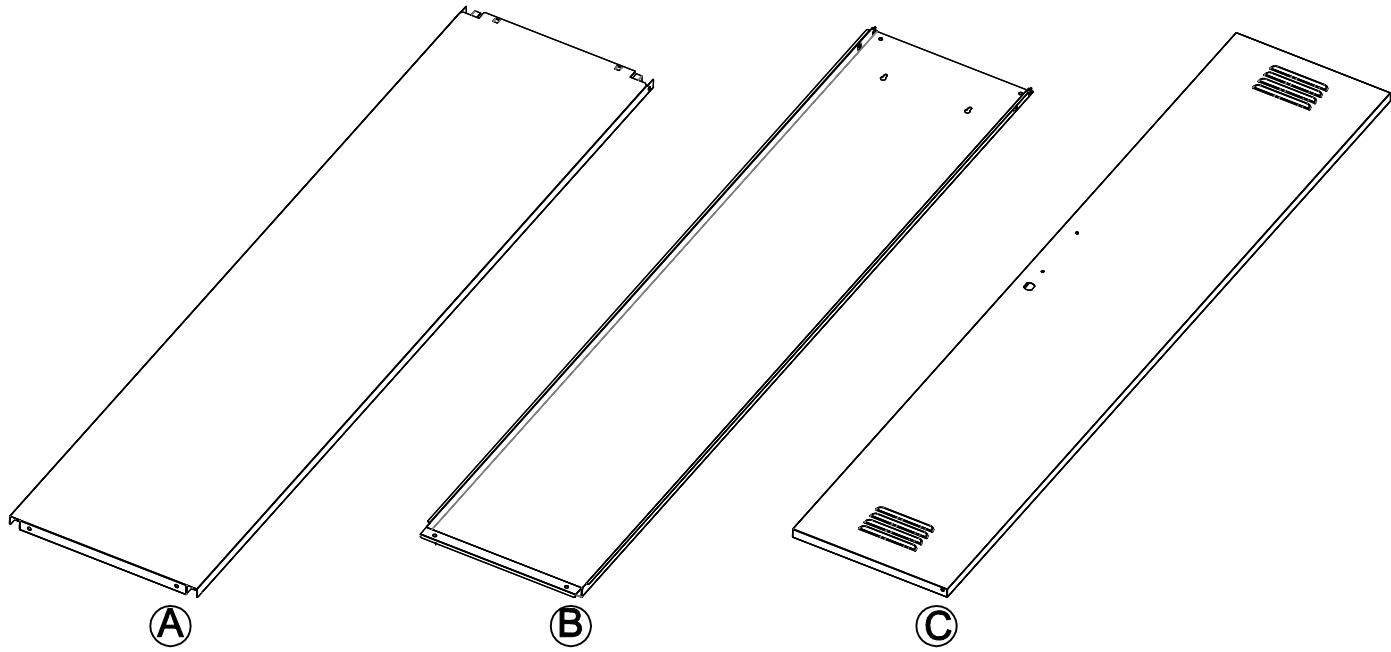

Ⓐ
X 2

Ⓑ

Ⓒ

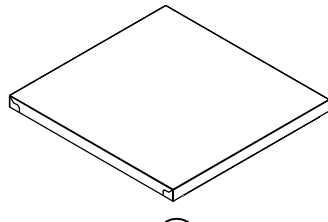

Ⓓ
TOP

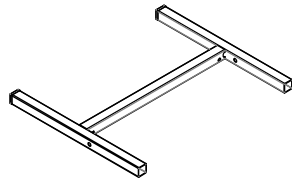

Ⓔ
X 2

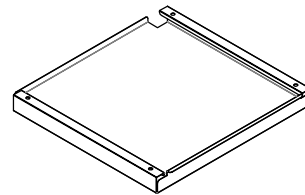

Ⓕ

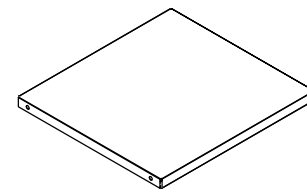

Ⓖ
X 3

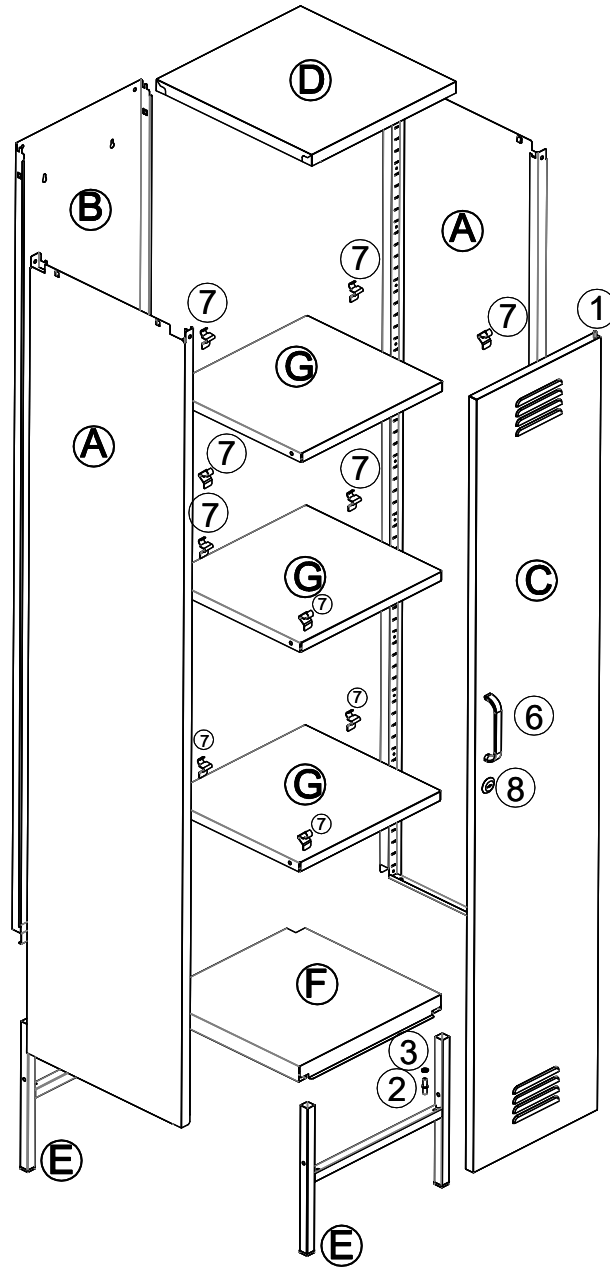

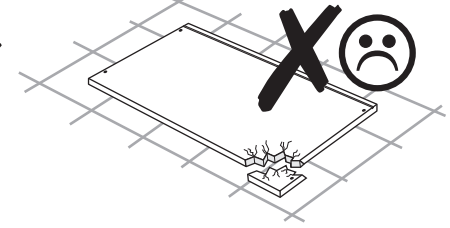
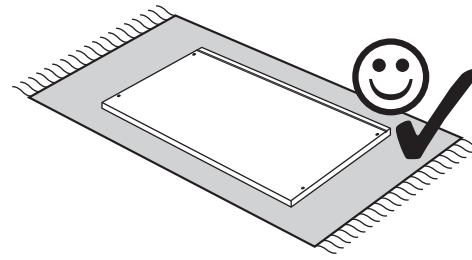
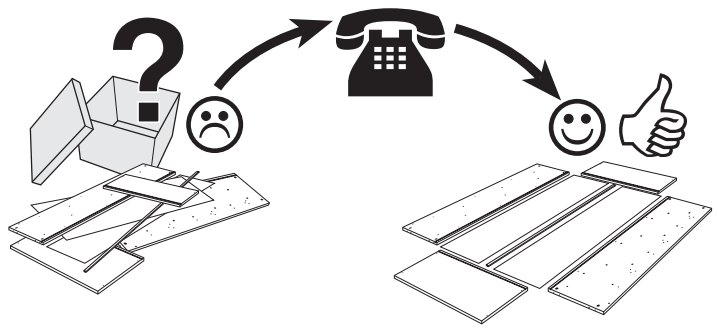

1

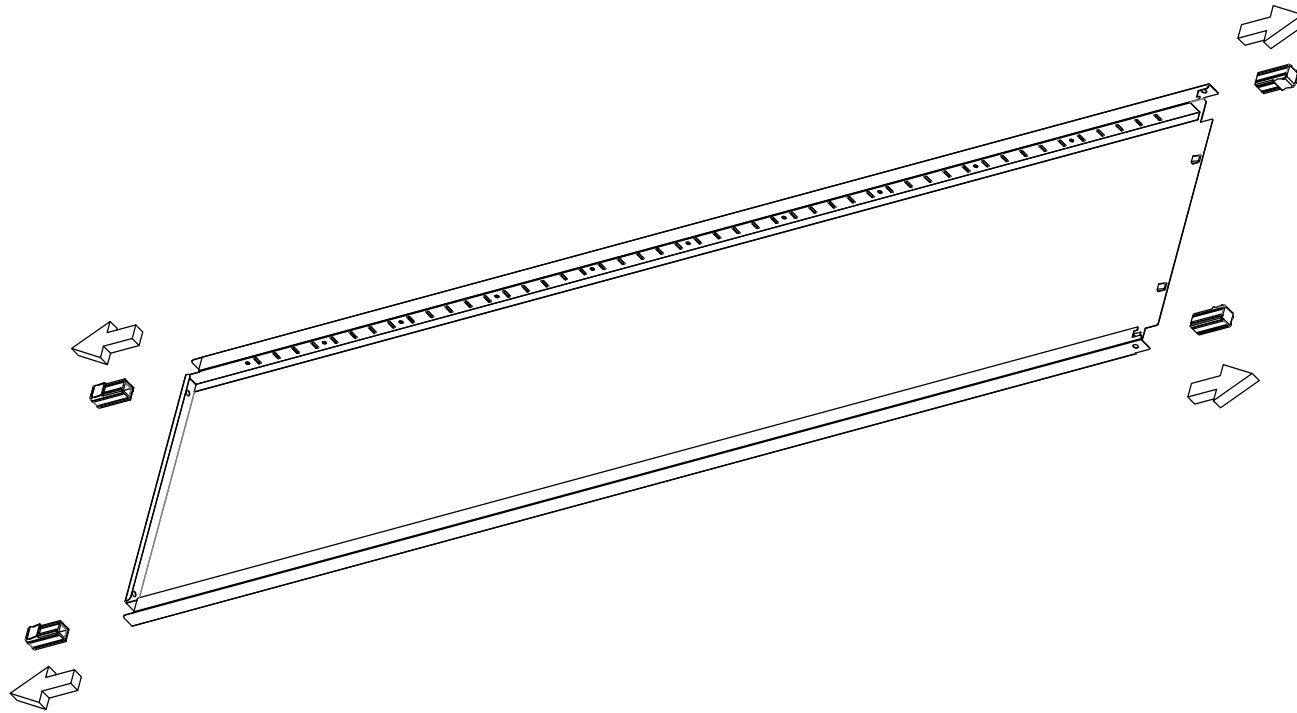

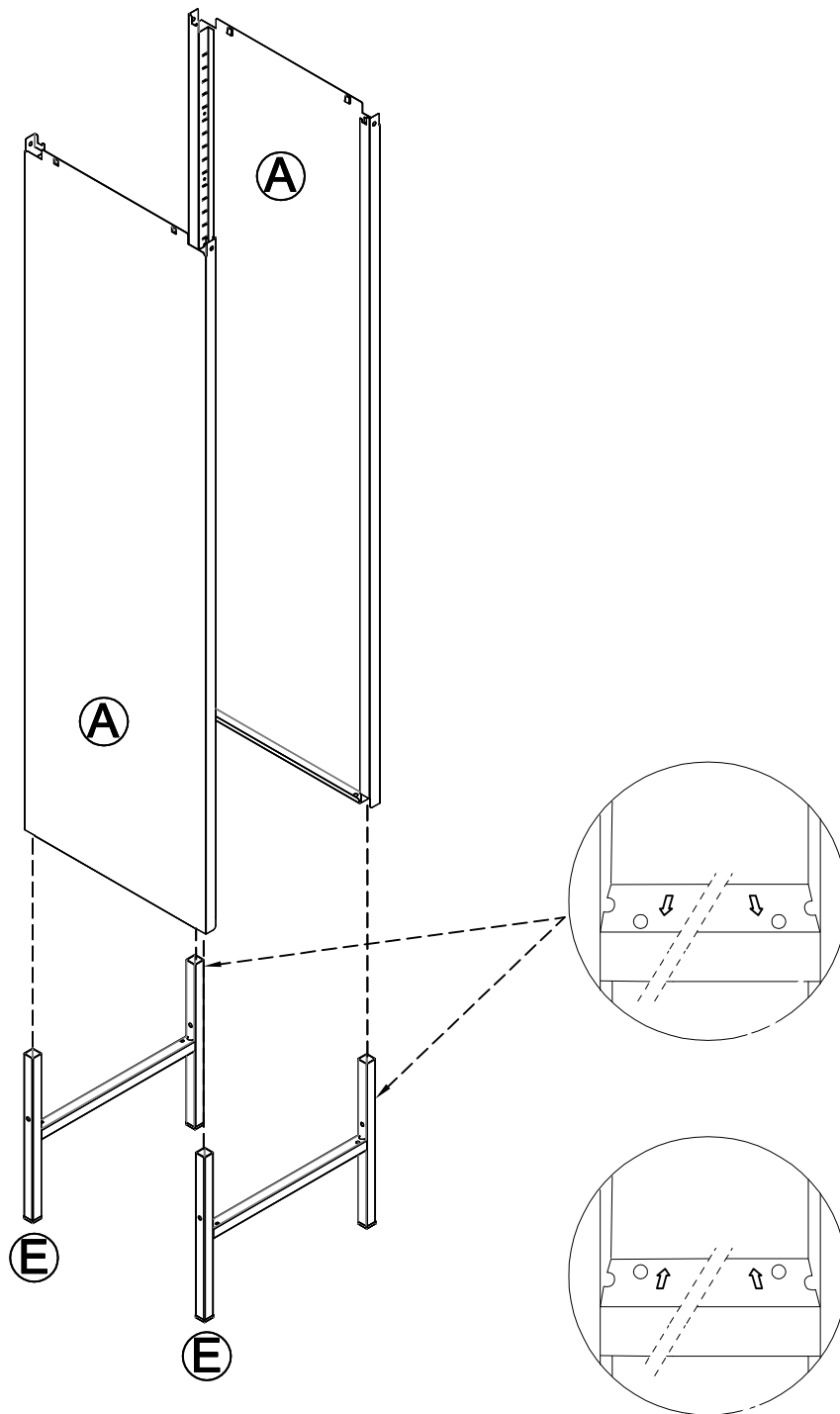

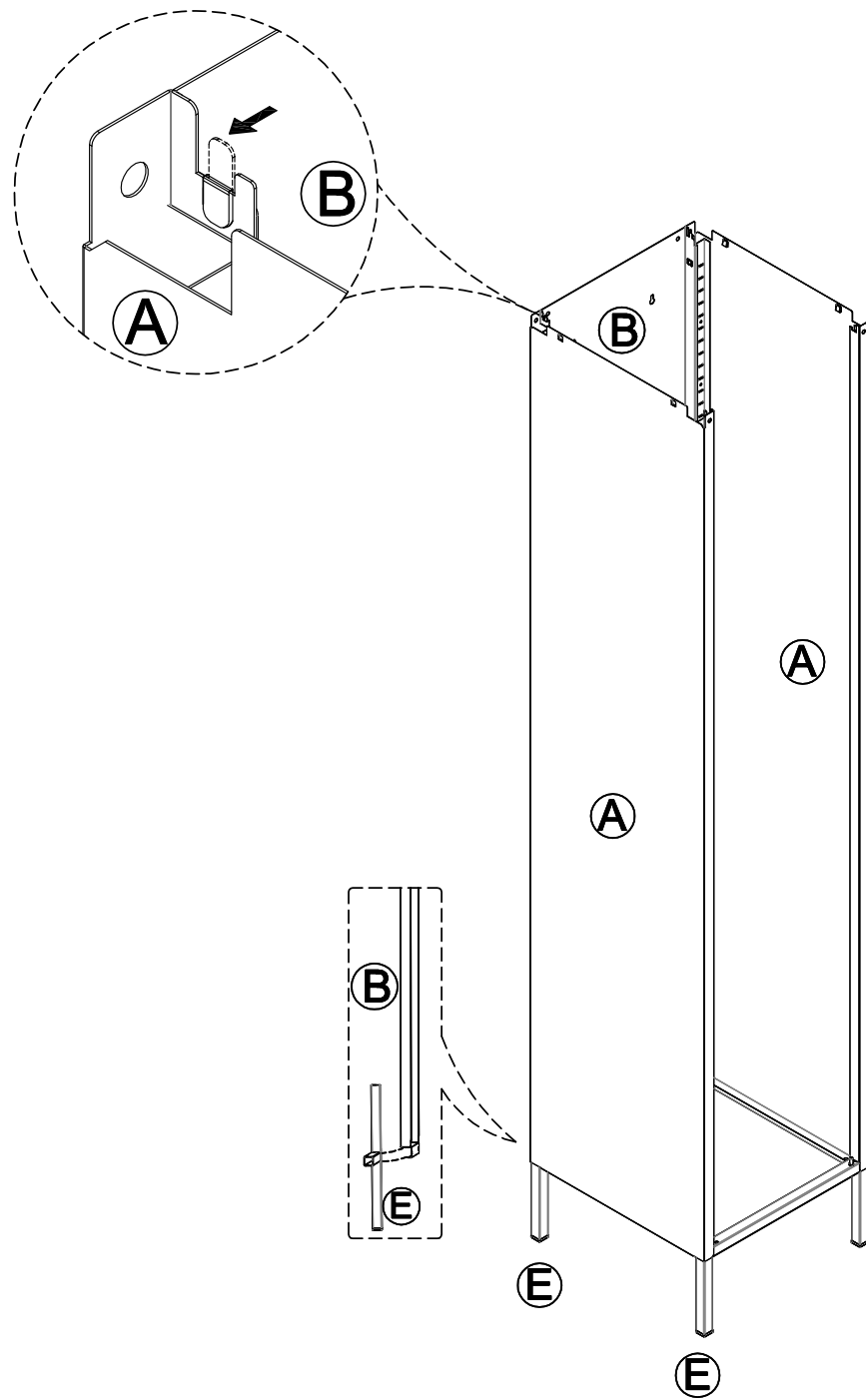

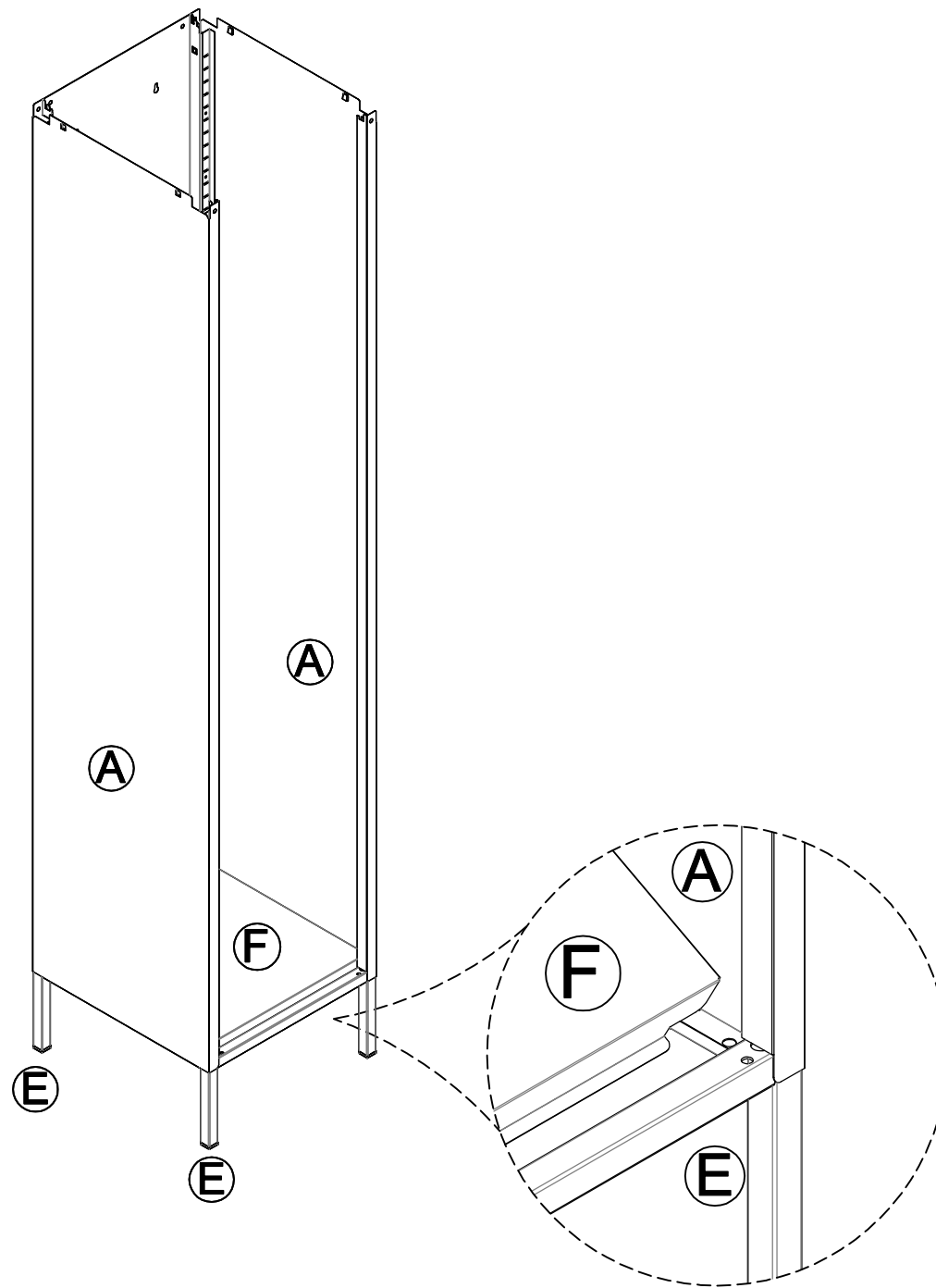

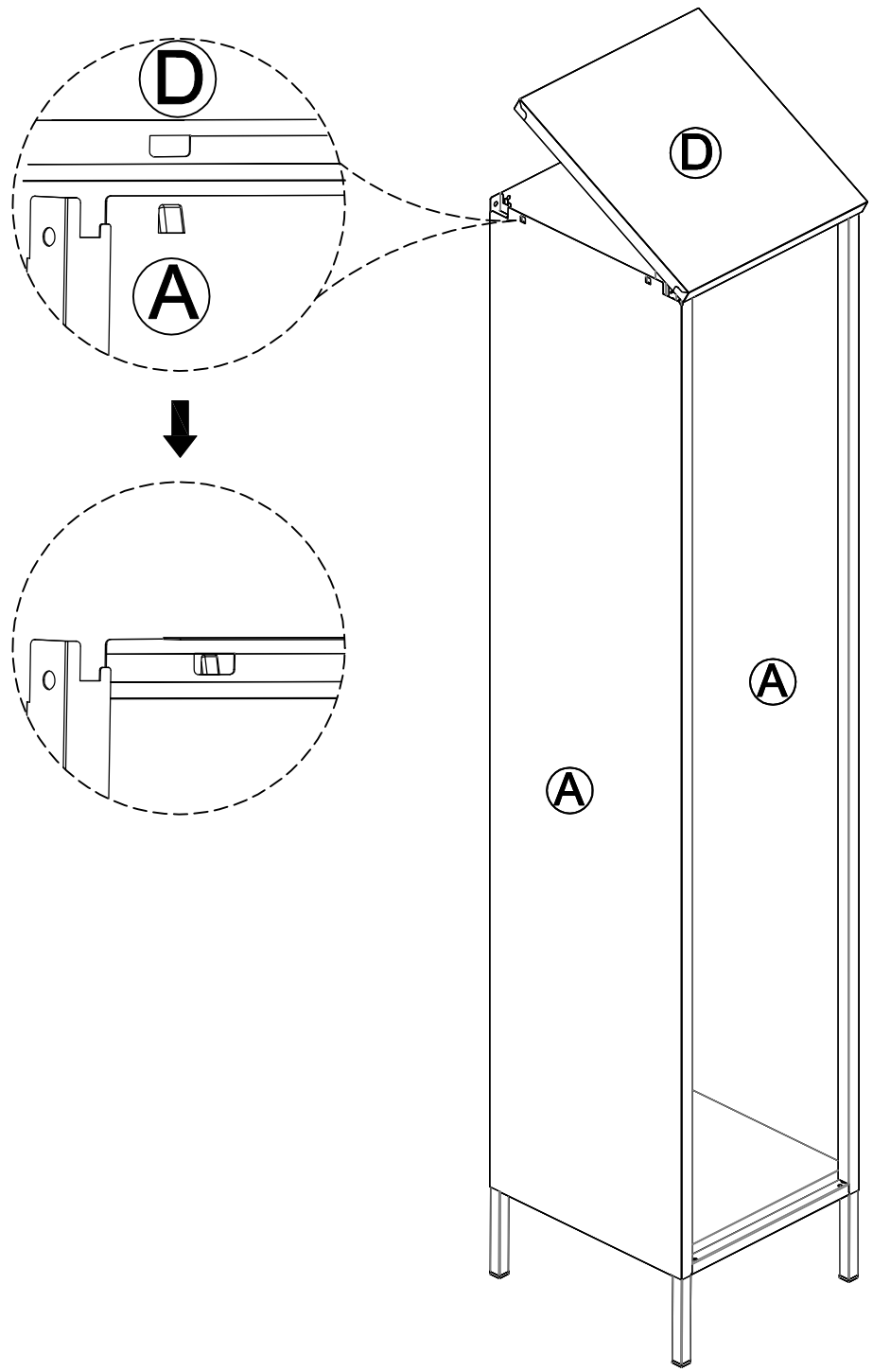

6

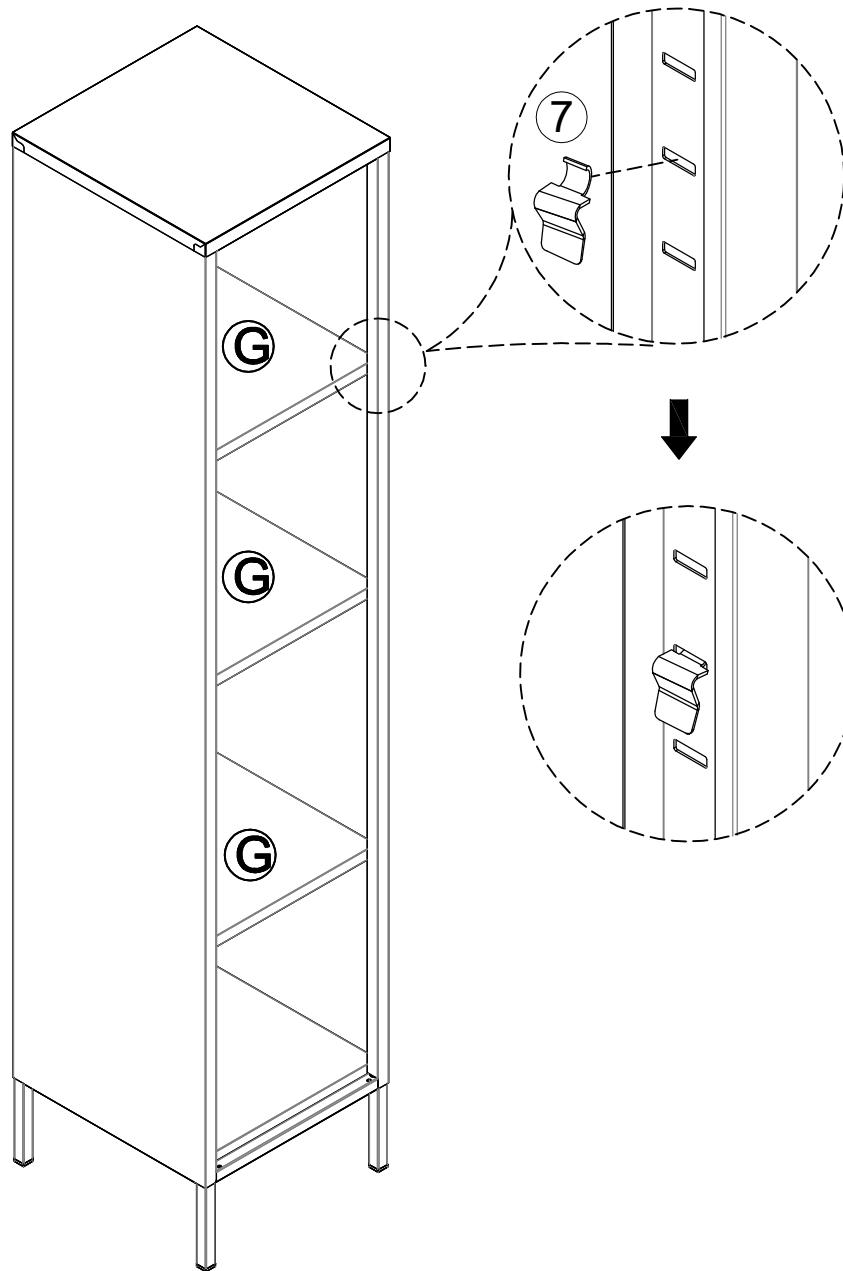
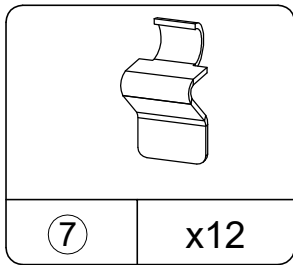

7

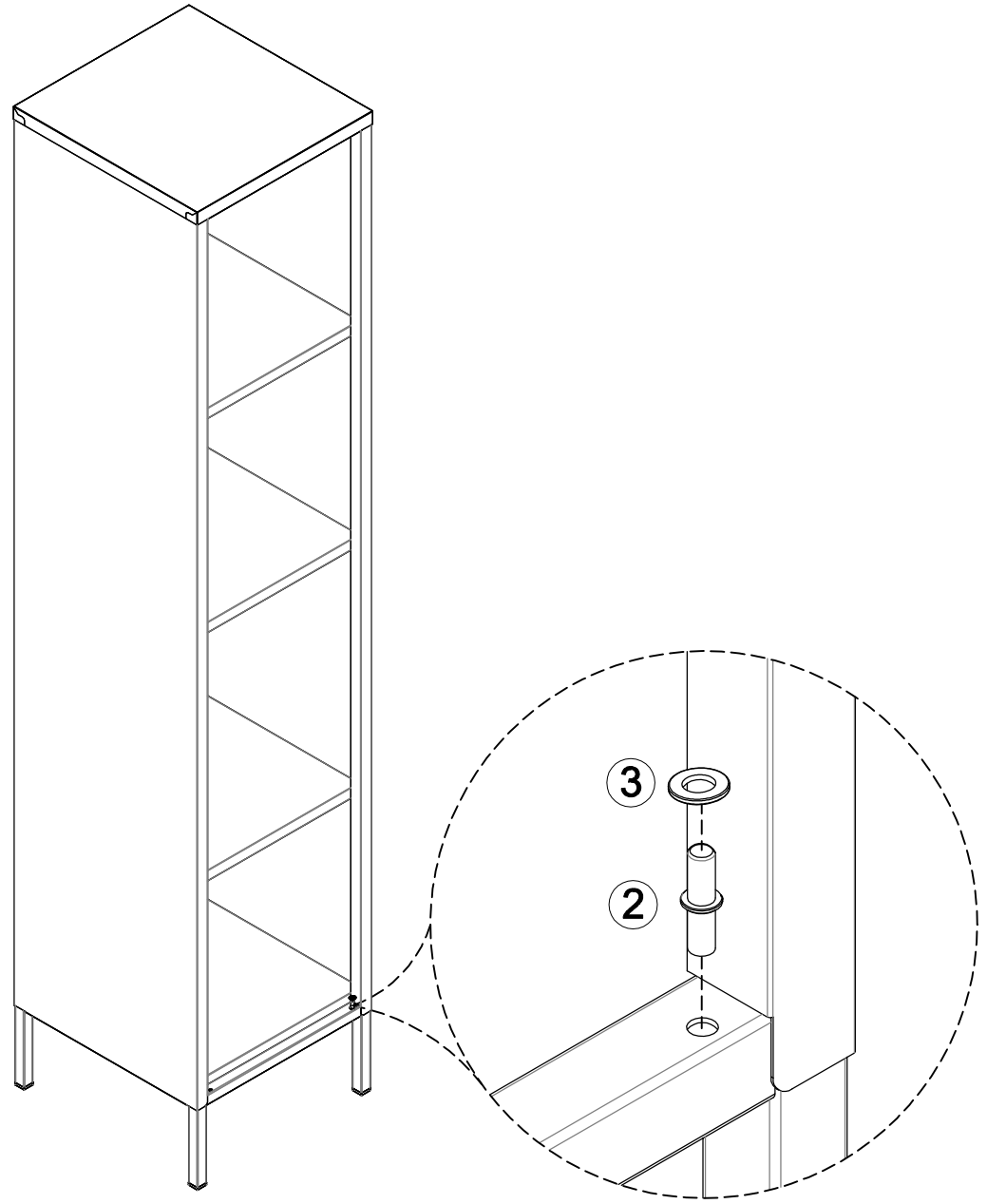
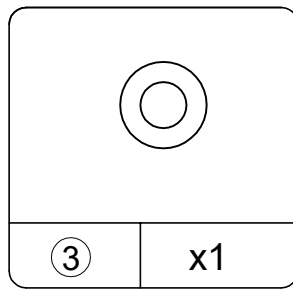
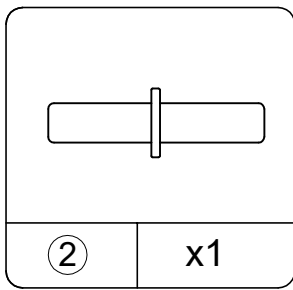

8

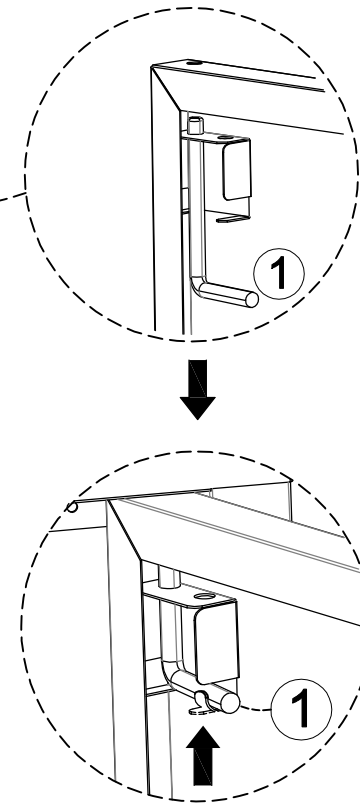
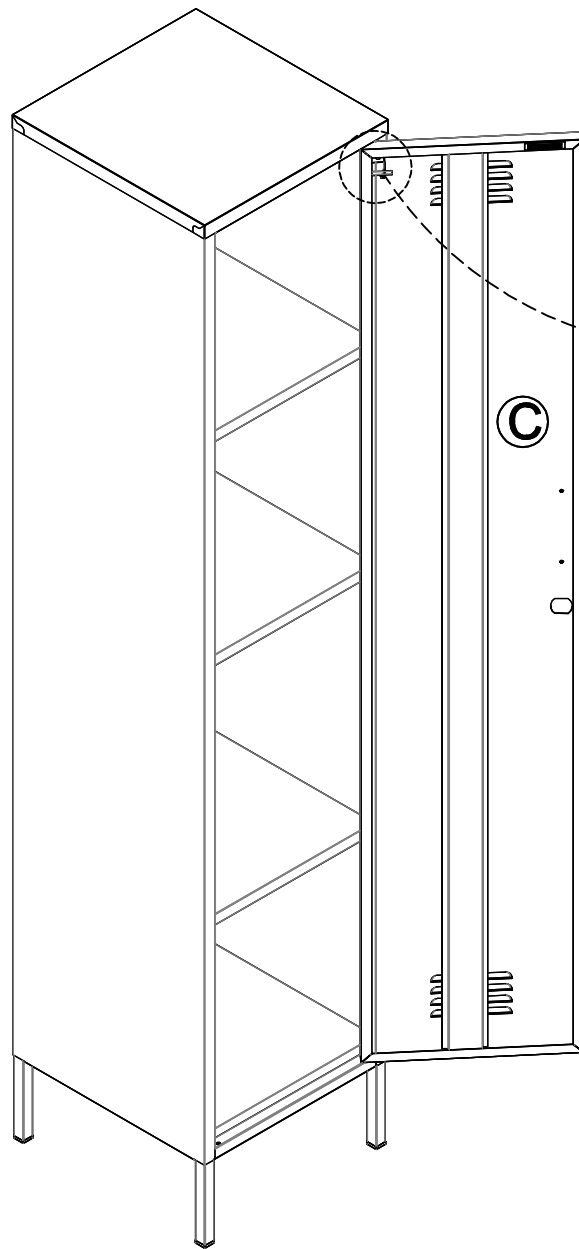
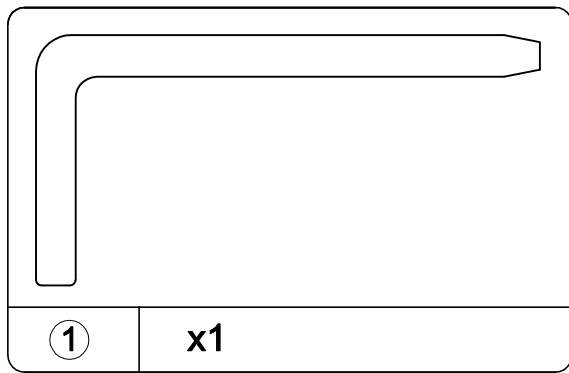

9

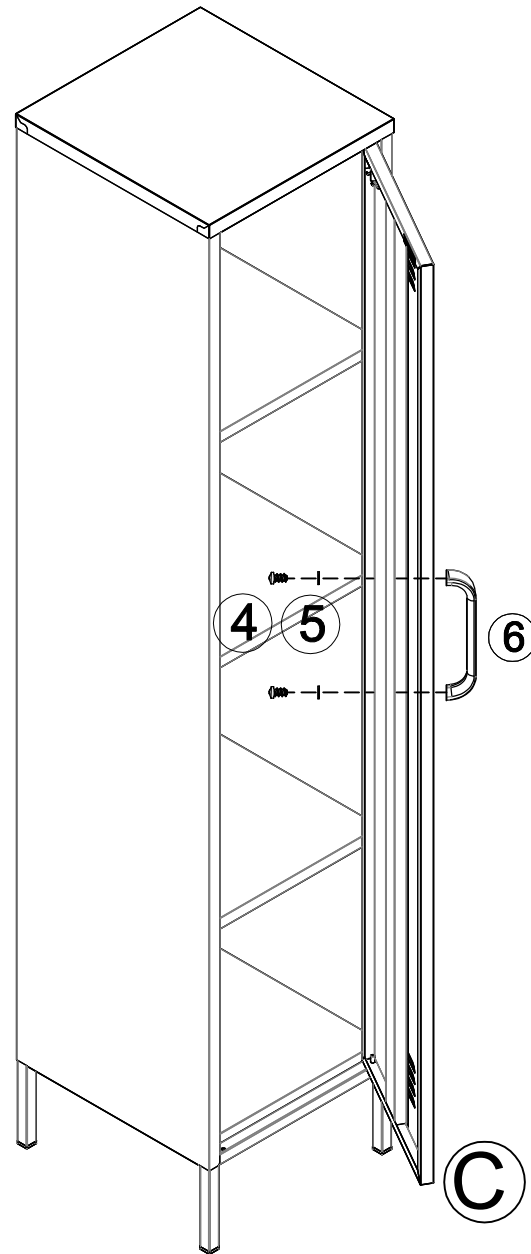
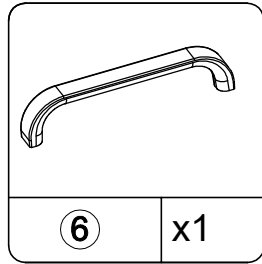
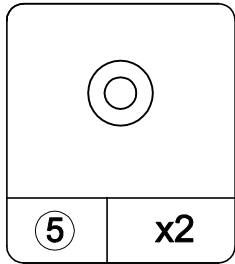
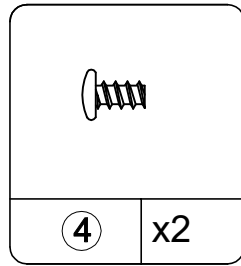
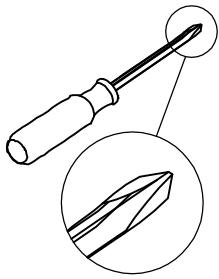

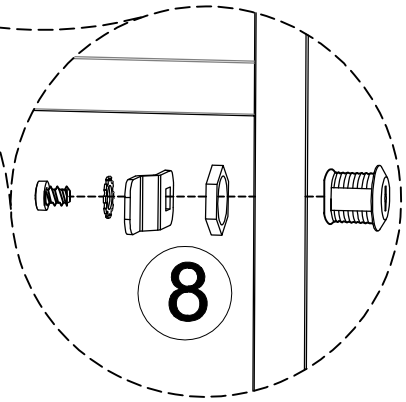
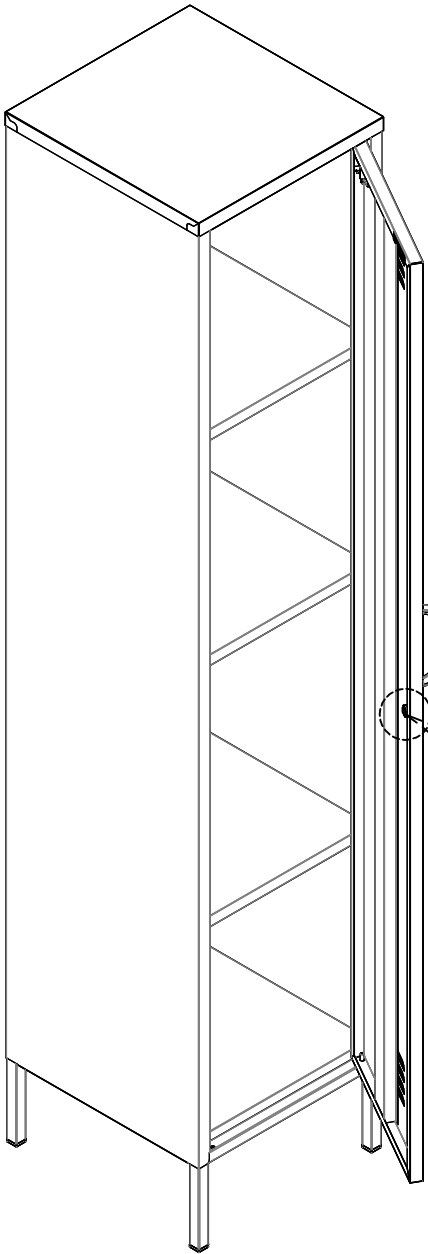
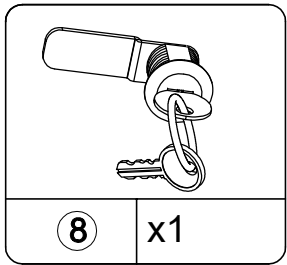
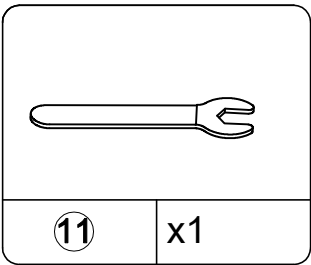
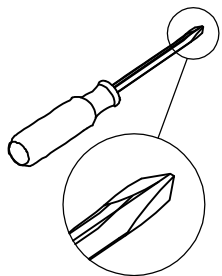

10

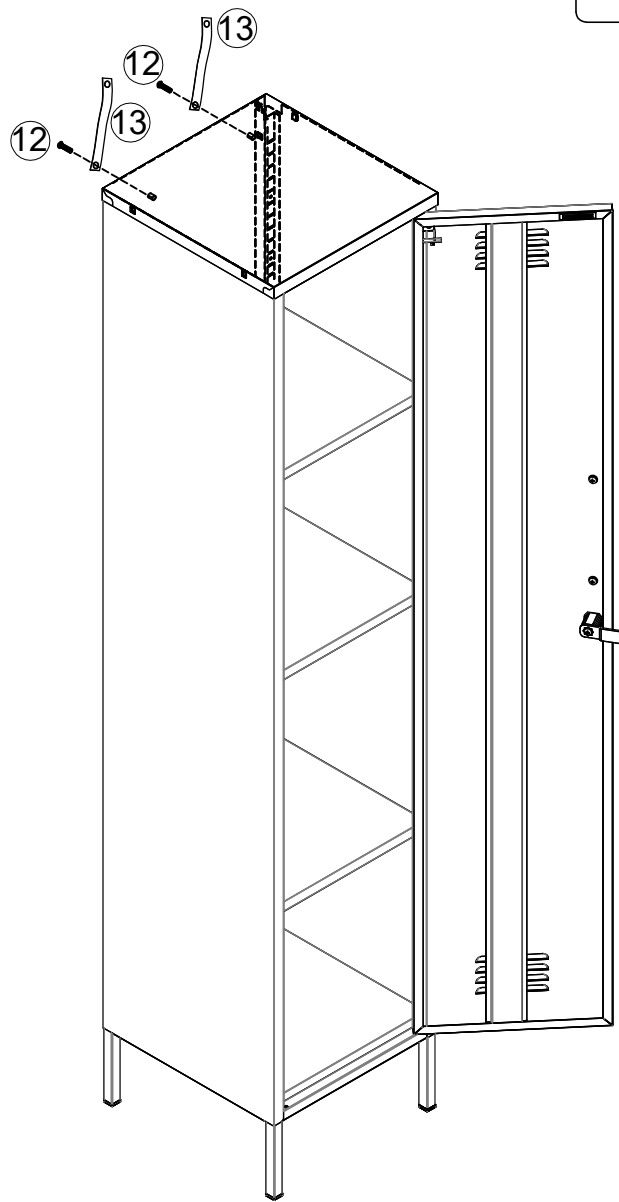
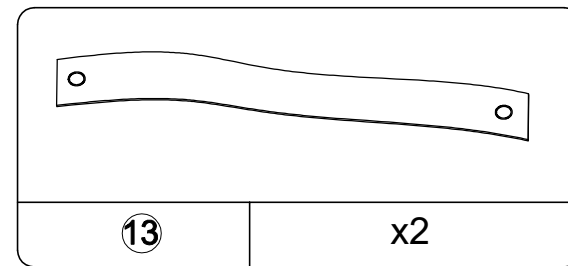
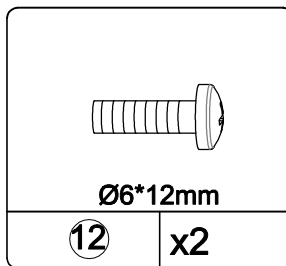
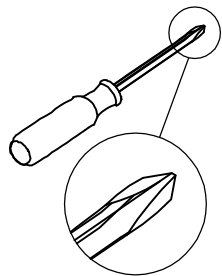

11

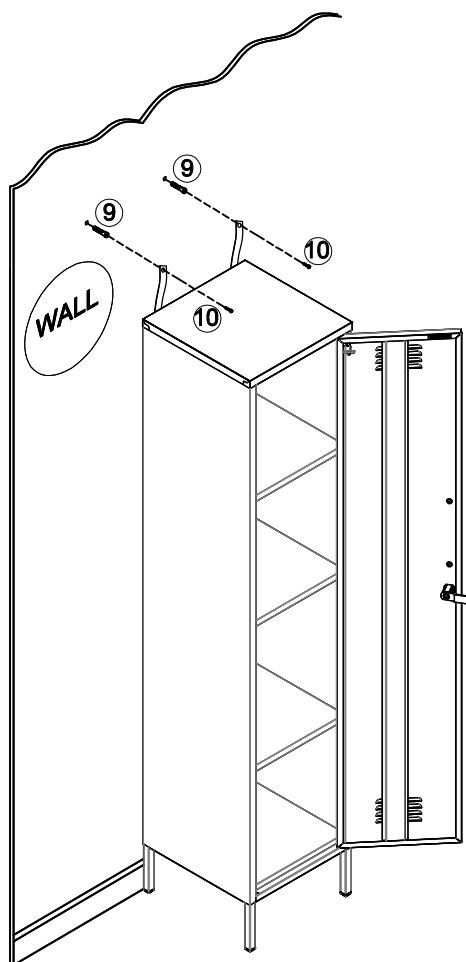
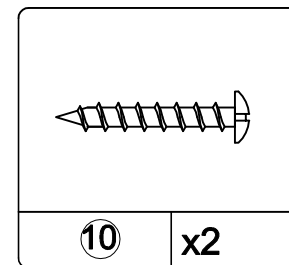
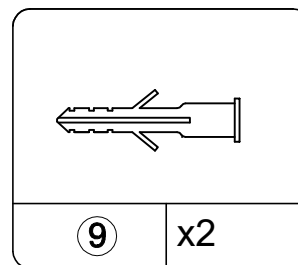
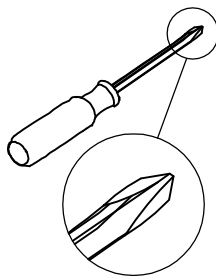



 Achtung • Attention • Attenzione • Opgelet • Uwaga • Pozor • Figyelem Atenție • Dikkat • Внимание 			
D	Wandbefestigung dient als Kippschutz – unbedingt anbringen! Bei einigen Wandtypen kann ein Spezialdübel erforderlich sein!	CZ	Montáž na stěnu slouží jako ochrana proti převrnutí – bezpodmínečně umístěte! U některých typů stěn může být zapotřebí speciální hmoždinka!
GB	The wall fastening serves to prevent tipping – be absolutely sure to mount it! For certain wall types, a special wall plug may be necessary!	SK	Upevnenie na stenu slúži ako ochrana proti prevráteniu – bezpodmínečne použite! Pre niektoré druhy stien môže byť potrebná špeciálna hmoždinka!
FR	La fixation murale sert de protection contre le basculement – à installer impérativement ! Pour certains types de murs il faut des chevilles spéciales !	HU	A terméket a falhoz kel rögzíténi, különben az felborulhat! Egyes faltípusoknál speciális tiplit kell használni!
IT	Il fissaggio alla parete serve da protezione anti-ribaltamento – attaccarla assolutamente! Per alcune strutture di parete può essere necessario un tassello speciale!	RO	Sistemul de fixare la perete servește ca protecție la răsturnare – de montat obligatoriu! Pentru unele tipuri de pereți este posibil să fie necesar un diblu special!
NL	Bevestiging aan de muur dient als kantelbescherming – zeker en vast bevestigen! Bij enkele muurtypes is een speciale plugmisschien vereist!	TR	Duvardaki sabitleme, devrilmeye karşı bir emniyet tedbiridir ve mutlaka monte edilmelidir! Bazı duvar tiplerinde bunun için özel bir dübel gerekli olabilir!
PL	Mocowanie do ściany jest jednocześnie zabezpieczeniem przed przewróceniem – koniecznie zamontować! Do niektórych rodzajów ścian koniecznie zastosować specjalne kołki mocujące.	RU	Обязательно установите крепление на стене во избежание опрокидывания! Для некоторых типов стен может потребо- ваться специальный дюбель!

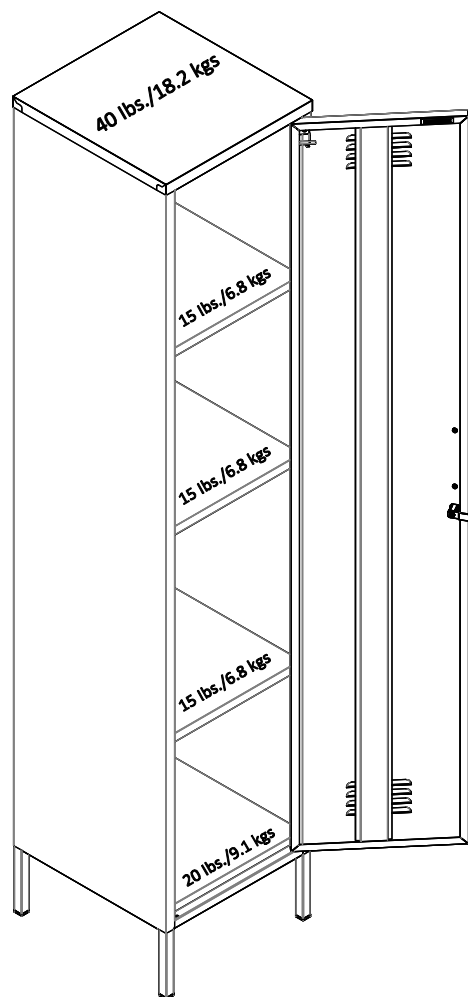



D	Ziehen Sie alle Schrauben sowie tragende Verbindungsteile nach ca. 5 Wochen nach, um eine dauer-hafte Standsicherheit zu gewährleisten.
GB	After approx. 5 weeks, tighten all screws and load-bearing connecting parts to ensure permanent sta-bility.
FR	Resserrez toutes les vis ainsi que les pièces de fixation au bout d'environ 5 semaines pour garantir une sécurité de fixation durable.
IT	Ristringere tutte le viti e giunture dopo ca. 5 settimane, al fine di garantire una durevole solidità.
NL	Draai alle schroeven en ook dragende verbindingstukken na ca. 5 weken nog eens vast, zodat een continue stabiliteit wordt gegarandeerd.
PL	Prosimy po ok. 5 tygodniach dokręcić wszystkie śruby w elementach łączeniowych. Zagwarantuje to Państwu trwałość i stabilność połączeń.
CZ	Dotáhněte všechny šrouby a nosné spojovací díly přibližně po 5 týdnech, aby se zaručila trvalá stabi-lita.
SK	Po cca 4 týždňoch dotiahnite skrutky, aby bola zaručená ich trvalá stabilita.
HU	Húzza utána – kb. 5 hét múlva – az összes csavart és a teherhordó összekötő-alkatrészeket a biz-tonság érdekében.
RO	Pentru a asigura o stabilitate de durată, strângeți după cca. 5 săptămâni toate șuruburile, precum și toate elementele portante de legătură.
TR	Tüm vida ve taşıyıcı bağlantı parçalarını kalıcı bir duruş güvenliğini sağlamak için yaklaşık 5 hafta sonra tekrar sıkınız.
RU	Подкрутите все болты, а также несущие соединительные детали припл. через 5 недель для обеспечения устойчивости в течение длительного времени.
D	Bitte nur mit einem Staubtuch oder leicht feuchtem Lappen reinigen. Keine scheuernden Putzmittel verwenden.
GB	Please only clean with a duster or a damp cloth. Do no use any abrasive cleaners.
FR	Veillez nettoyer uniquement avec un chiffon à poussière ou un chiffon légèrement humide. Ne pas utiliser de détergent abrasif.
IT	Si raccomanda di pulire sono con un panno per la polvere o uno strofinaccio umido. Non utilizzare detersivi abrasivi.
NL	Reinig alleen met een stofdoek of een lichtjes vochtige doek. Gebruik geen schurende poetsmid-delen.
PL	Czyszczenie należy wykonać wyłącznie za pomocą ściereczki lub lekko nawilżonego ręcznika. Nie stosować środków czyszczących do szorowania.
CZ	Čistěte prosím jen prachovkou nebo lehce navlhčeným hadrem. Nepoužívejte drhnoucí čisticí prostředky.
SK	Na čistenie používajte len prachovku alebo zľahka navlhčenú utierku. Nepoužívajte žiadne drhnúce čistiace prostriedky.
HU	Kérjük, csak portórlő kendővel vagy enyhén nedves ronggyal tisztítsa. Ne használgjon dörzshatású tisztítószert.
RO	Vă rugăm să utilizați la curățare exclusiv o cârpă de șters praful sau o cârpă ușor umezită. Nu utilizați substanțe de curățat abrazive.
TR	Lütfen sadece bir toz beziyle veya hafif nemli yumuşak bir bezle siliniz. Aşındırıcı temizlik malzemeleri kullanmayınız.
RU	Очищайте от пыли тряпкой или слегка влажной ветошью. Не допускается применение чистящих средств, не предназначенных для ухода за мебелью.