

ASSEMBLY INSTRUCTIONS

SKU CODE: (WF305615/WF305616)

Made in Vietnam

Distributed in the USA by:

GIGACLOUD TECHNOLOGY(USA) INC

18961 ARENTH AVENUE,

CITY OF INDUSTRY, CA, 91748

626-912-8886 Ext. 100

bs@gigacloudtech.com

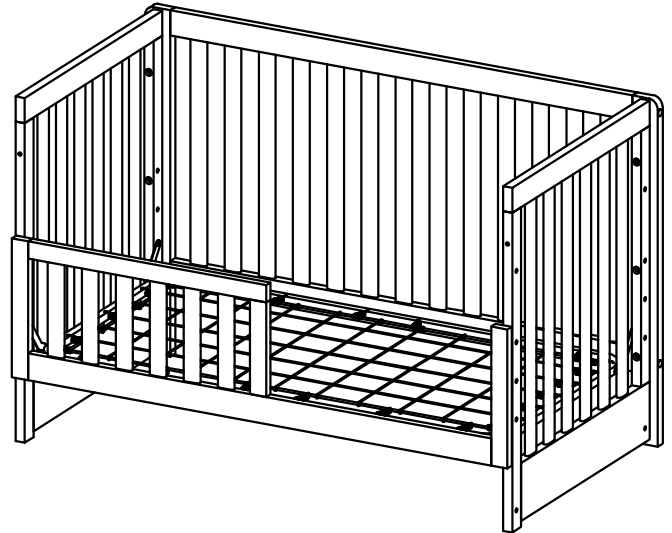
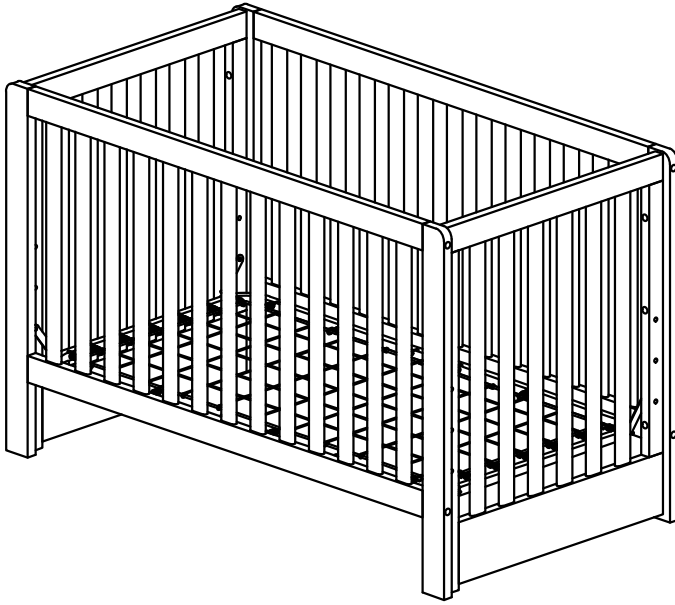

WARNING: Read all

instructions before assembling this product.

KEEP INSTRUCTIONS FOR FUTURE USE.

CUSTOMER SERVICE

If you are missing parts or have any questions about this product, contact us first. You can also order parts by writing to the address above.

Include the product model number, color, and a brief description of the part.

CARE AND CLEANING

DO NOT scratch or chip the finish. **DO NOT** use abrasive chemicals for cleaning. Dust often using a clean, soft, dry cloth.

Blot spills immediately and wipe with a clean, damp cloth. If the crib is to be stored, store in a cool, dry place and carefully package all original hardware to protect from loss.

TOOLS NEEDED

Allen key (included)

NOTE: Two people are recommended for assembly.

NOTE: When inserting bolts, turn clockwise until tight. Then loosen $\frac{1}{2}$ - $\frac{3}{4}$ of a turn. After crib is completely assembled, return each bolt and tighten. Use wax or soap on all bolts to facilitate assembly.

IMPORTANT SAFETY INFORMATION FOR CRIBS

 **WARNING:** Infants can suffocate on soft bedding. Never add a pillow or comforter. Never place additional padding under an infant.

 **WARNING:** Failure to follow these warnings and the assembly instructions could result in serious injury or death.

- To reduce the risk of SIDS, pediatricians recommend healthy infants to be placed on their backs to sleep, unless otherwise approved by your physician.

Strangulation Hazard:

- Strings can cause strangulation! **DO NOT** place items with a string around a child's neck, such as hood strings or pacifier cords. **DO NOT** suspend strings over a crib or attach strings to toys.
- To help prevent strangulation tighten all fasteners. A child can trap parts of the body or clothing on loose fasteners.
- **DO NOT** place crib near window where cords from blinds or drapes may strangle a child.

Fall Hazard:

- When a child is able to pull to a standing position, set mattress to lowest position and remove bumper pads, large toys and other objects that could serve as steps for climbing out.
- When child is able to climb out or reaches the height of 35" (89cm), the crib shall no longer be used, and the child should be placed in a youth or regular bed.
- Check this product for damaged hardware, loose joints, missing parts or sharp edges before and after assembly and frequently during use. Securely tighten loose bolts and other fasteners. **DO NOT** use crib if any parts are missing, damaged or broken. Contact Gigaloud Technology (USA) INC customer service at 626-912-8886 for replacement parts and instructional literature if needed.
- **DO NOT** substitute parts.
- **DO NOT** use a water mattress with this crib.
- If refinishing, use a non-toxic finish specified for children's products.
- Follow warnings on all products in a crib.
- Never use plastic shopping bags or other plastic film as mattress covers because they can cause suffocation.
- Infants can suffocate in gaps between crib sides and a mattress that is too small.

CAUTION: ANY MATTRESS USED IN THIS CRIB SHALL BE
AT LEAST 27 1/4" X 51 5/8" WITH A THICKNESS
NOT EXCEEDING 6".

ASSEMBLY INSTRUCTIONS

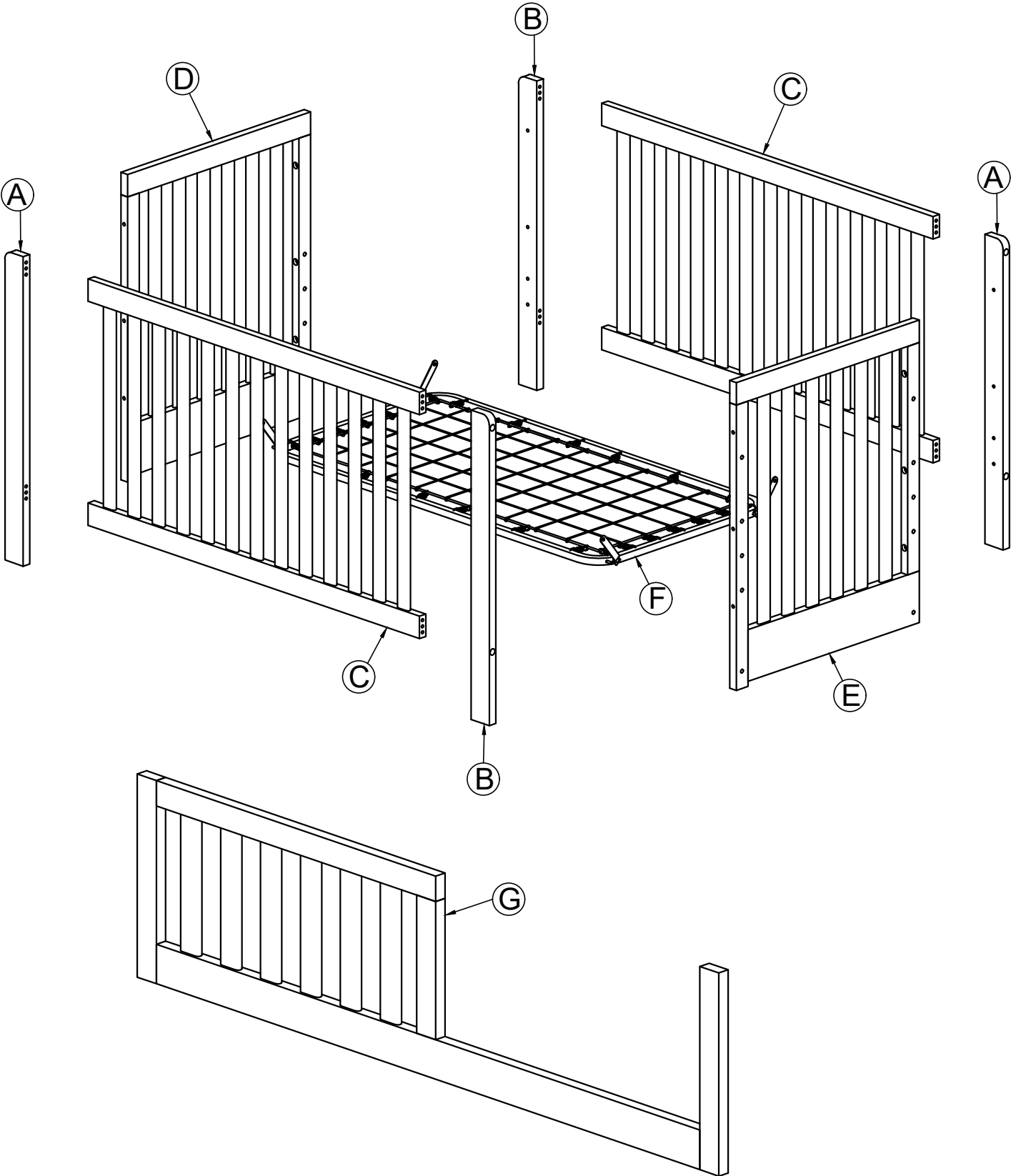

Part List (WF305615)

A

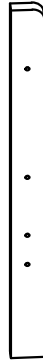

Left leg - 2pcs

B



Right leg - 2pcs

F

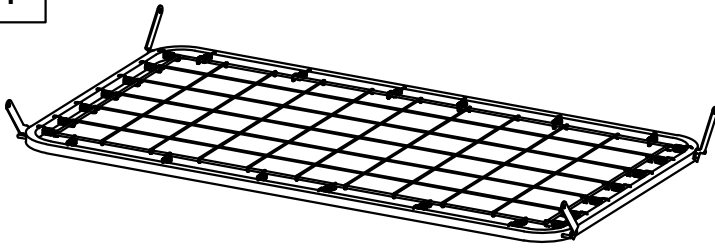

Metal cradle frame - 1pc

G

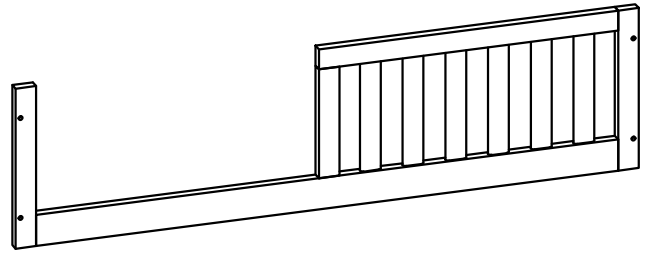

Guard Rail - 1pc

Part List & Hardware List (WF305616)

C

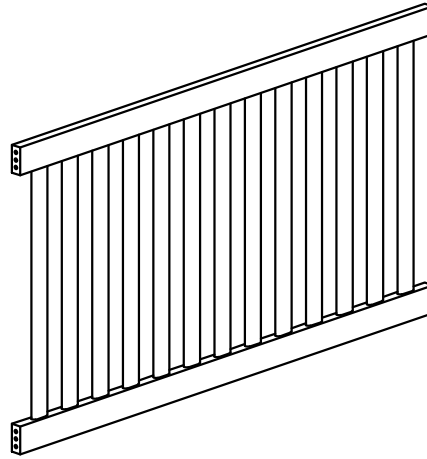

Headboard frame - 2pcs

D

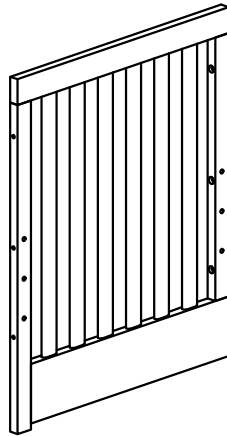

Left side frame - 1pc

E

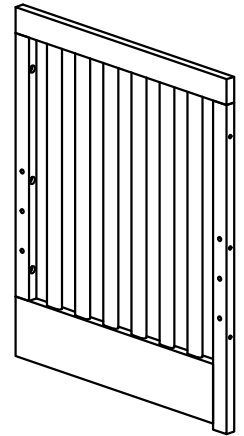

Right side frame - 1pc

Hardware List (WF305616)

1

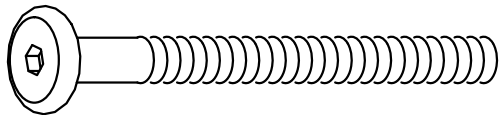

M6 x 70mm
Hex - Head bolts 8pcs

2

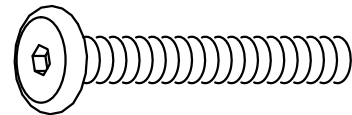

M6 x 50mm
Hex - Head bolts 12pcs

3

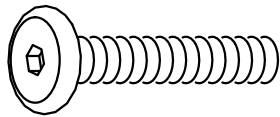

M6 x 25mm
Hex - Head bolts 4pcs

4

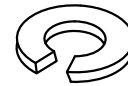

Ø10/Ø8mm
Lock washers 24pcs

5

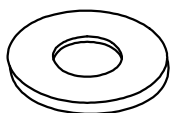

Ø16/Ø8mm
Plain washers 24pcs

6

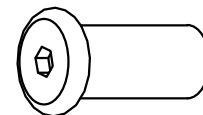

M6 x 18mm
Canopy head through 4pcs

7

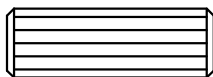

Ø10 x 30mm
Wood dowel 16pcs

8

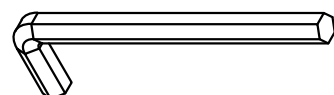



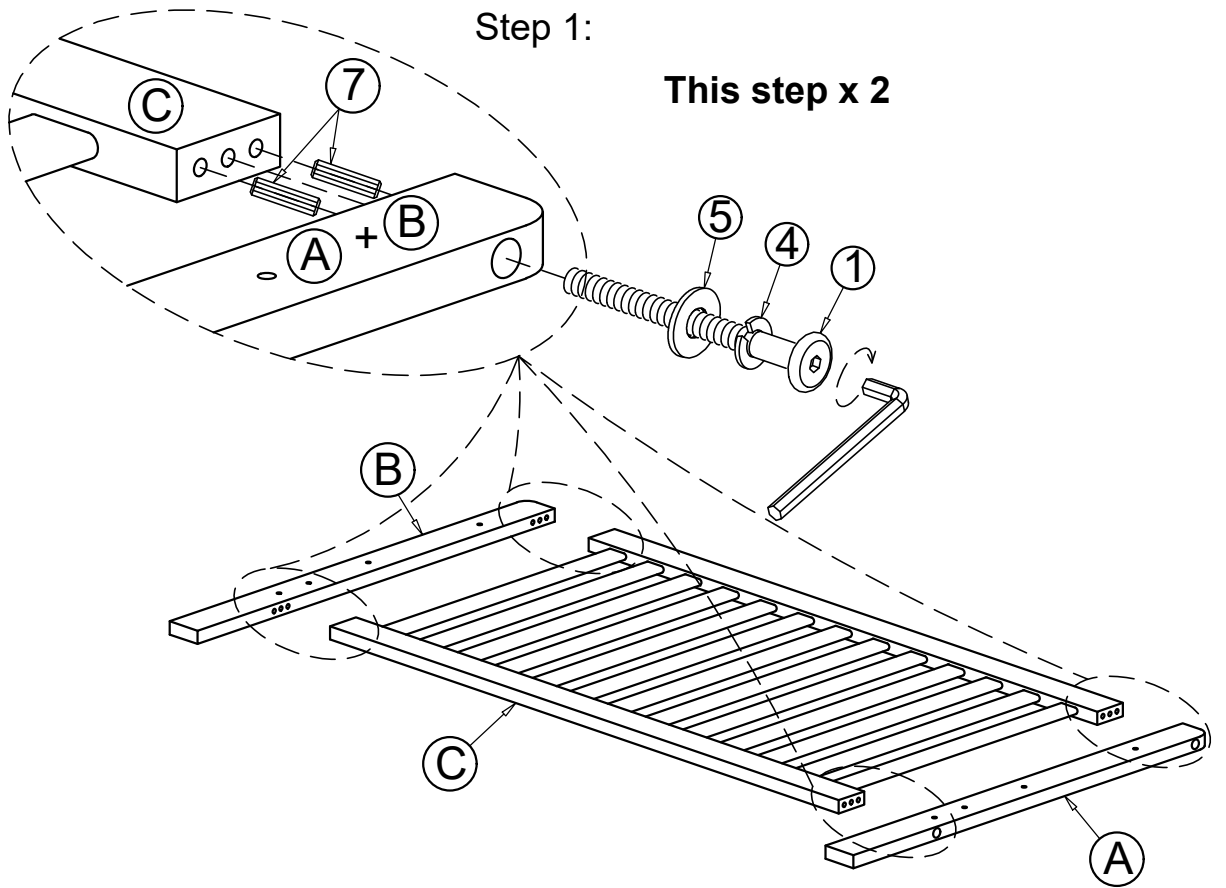

Allen Key 2pcs

Step 1:

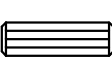

This step x 2



①	④	⑤	⑦	
				
Q.ty: 8pcs	Q.ty: 8pcs	Q.ty: 8pcs	Q.ty: 16pcs	

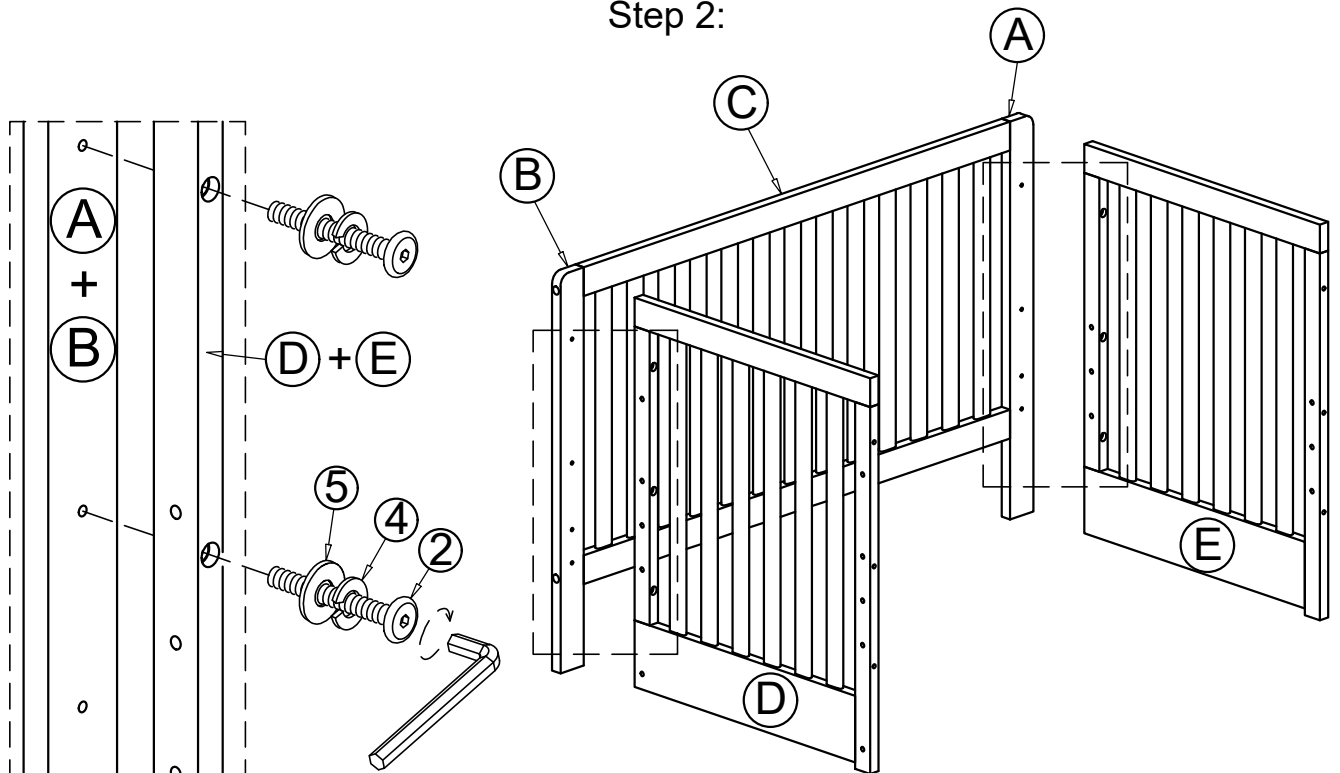

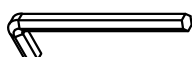

Step 2:

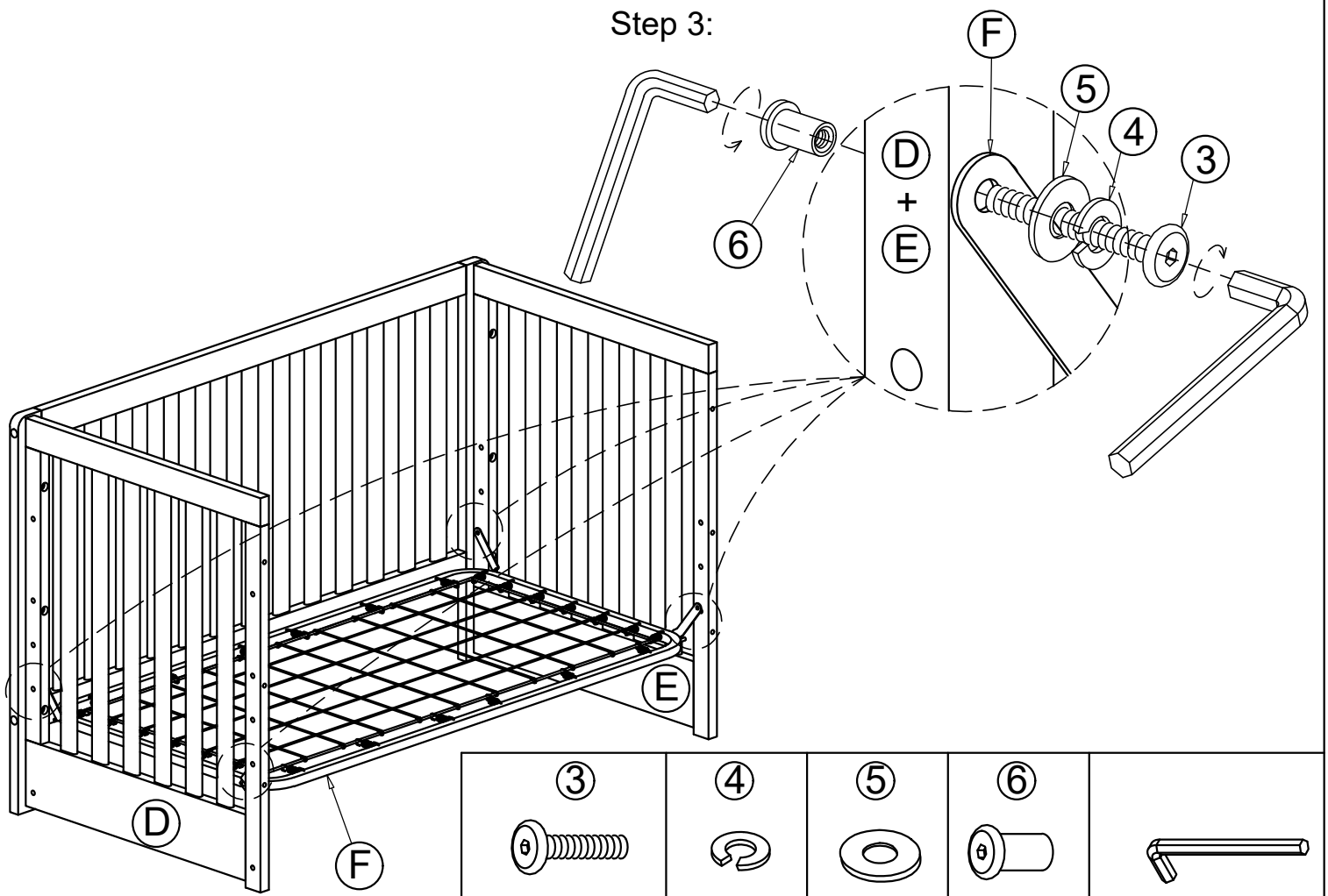

②	④	⑤	
			
Q.ty: 6pcs	Q.ty: 6pcs	Q.ty: 6pcs	

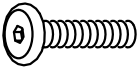



Step 3:

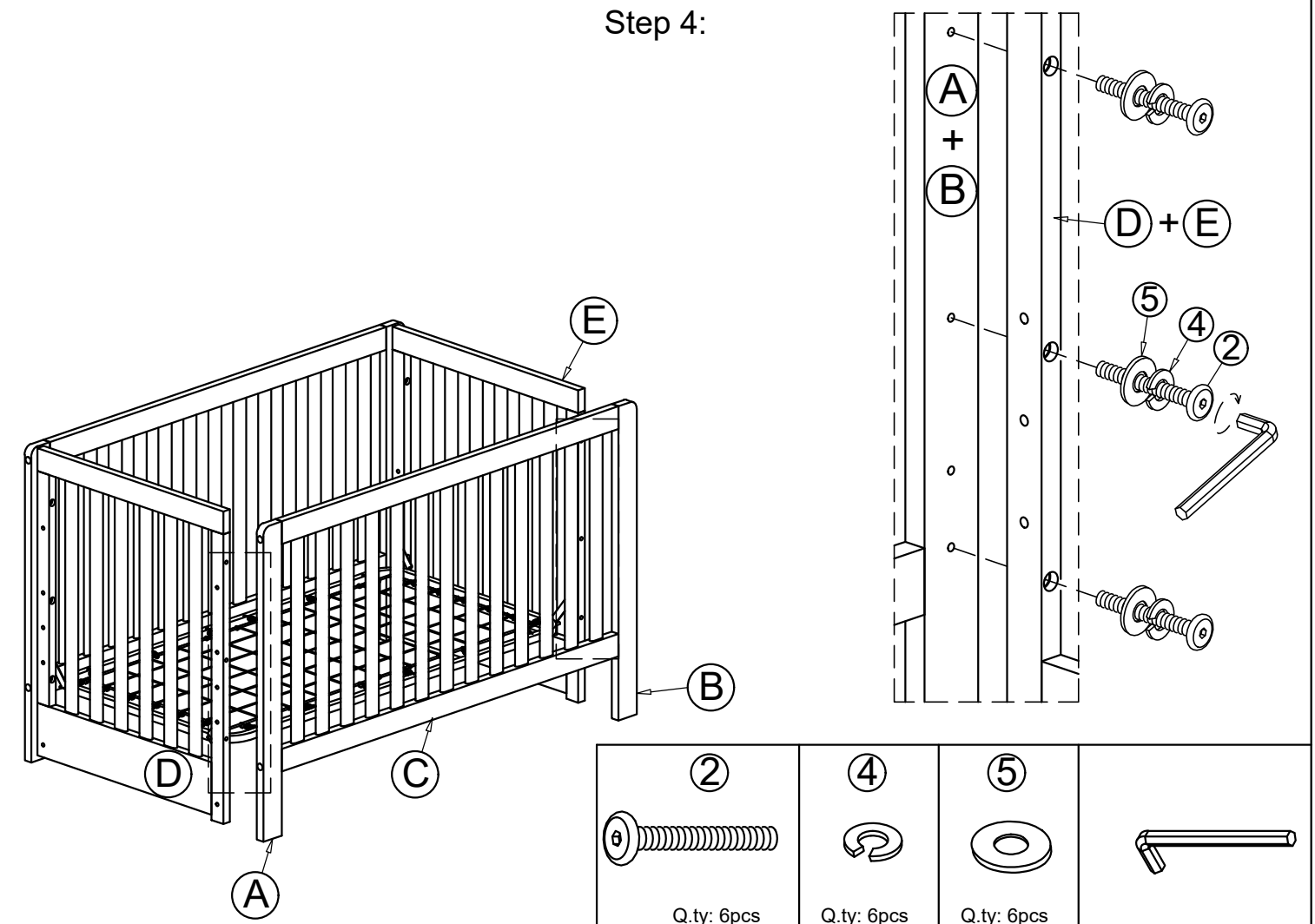

③	④	⑤	⑥	
				
Q.ty: 4pcs	Q.ty: 4pcs	Q.ty: 4pcs	Q.ty: 4pcs	

Step 4:



②	④	⑤	
			
Q.ty: 6pcs	Q.ty: 6pcs	Q.ty: 6pcs	

COMPLETE OF THE CRIB OPTION

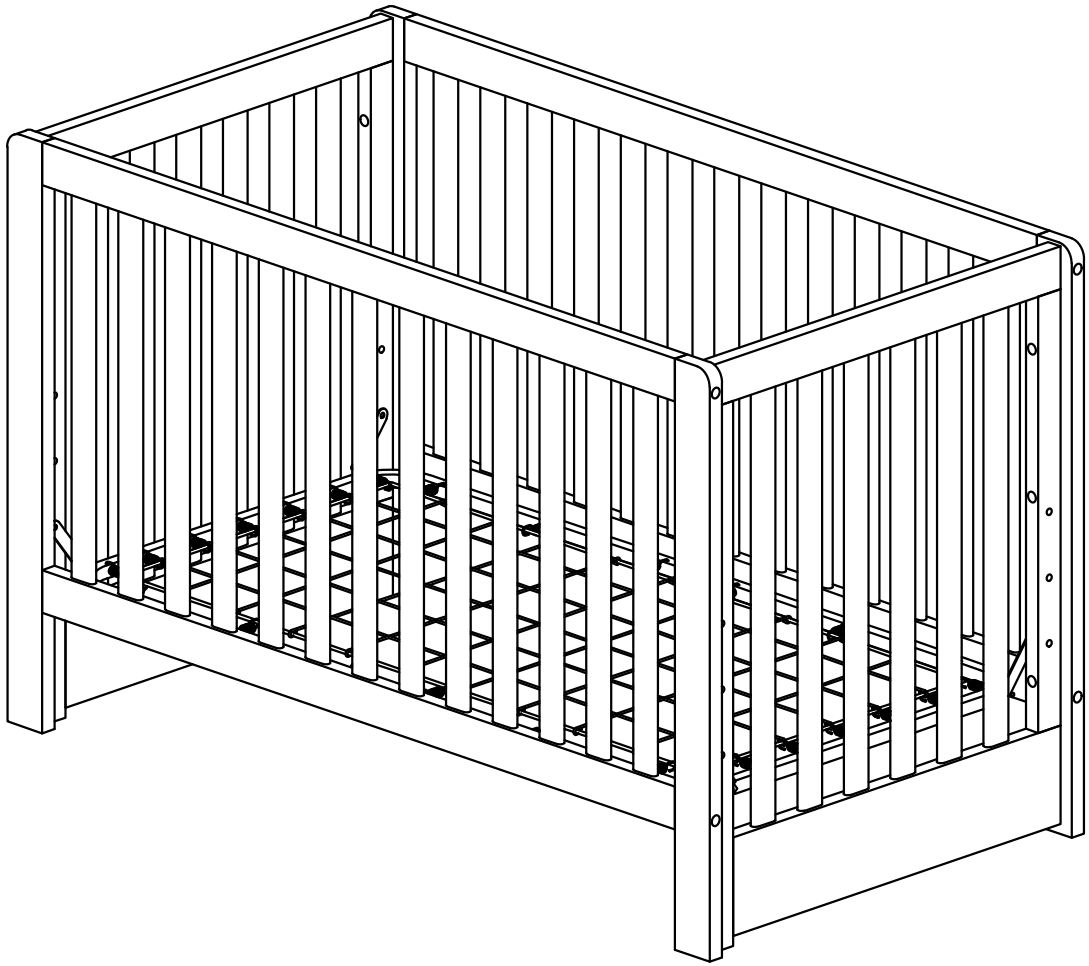

Step B1:

Remove the front frame from the crib

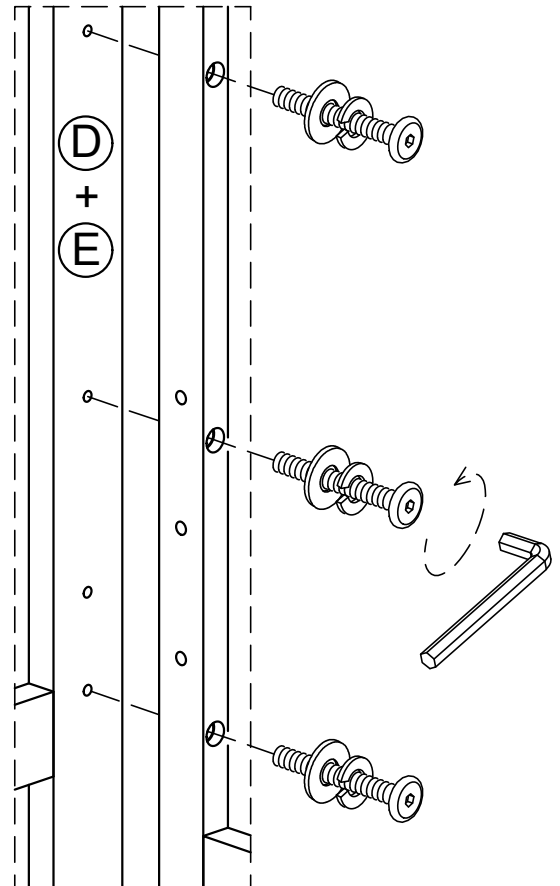
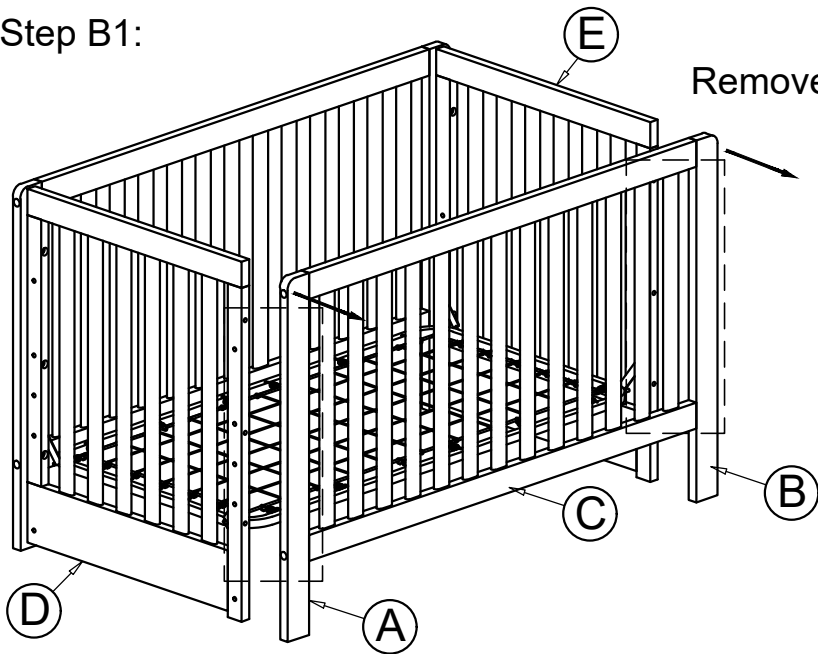

Step B2:

Use hardware of step B1

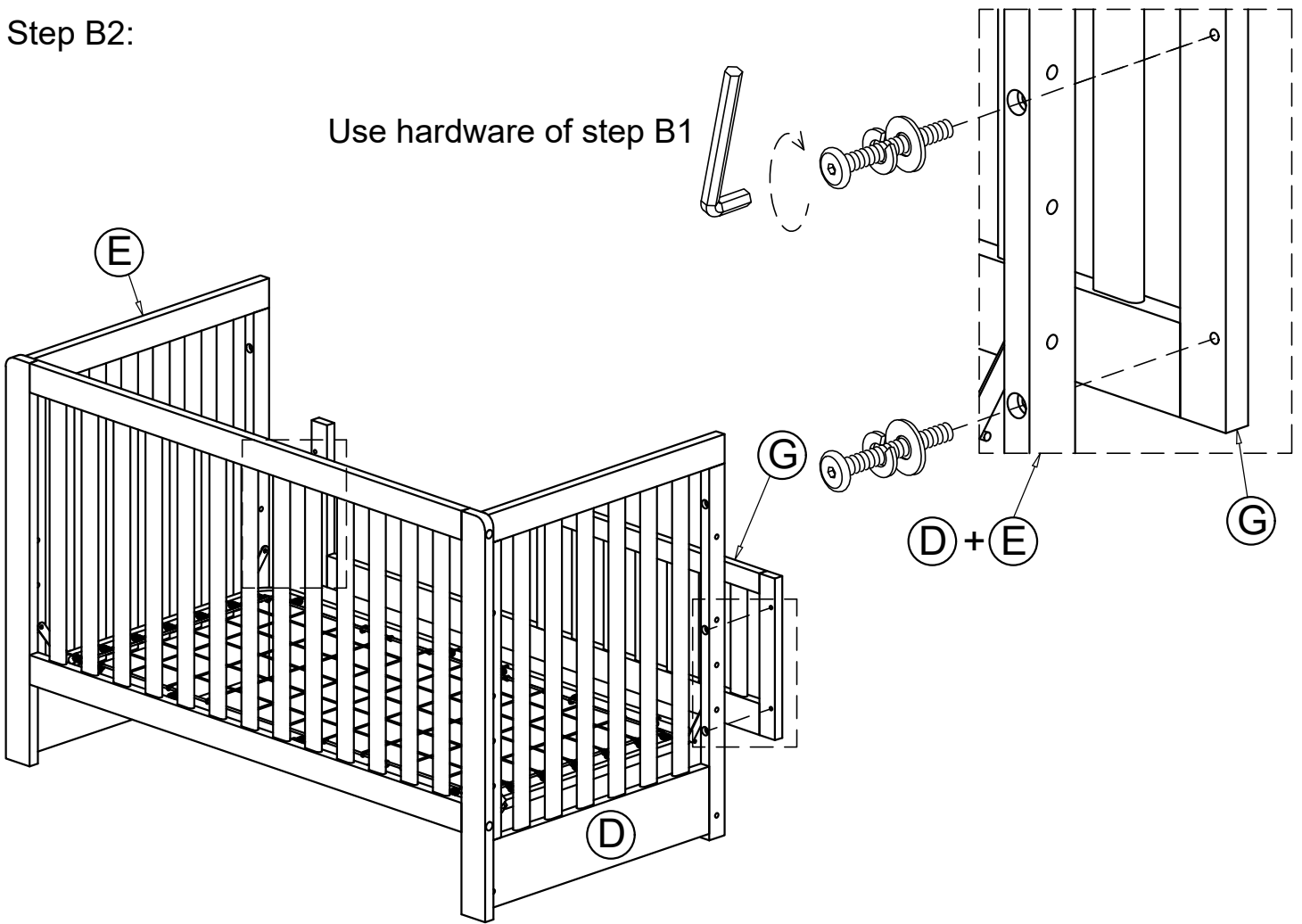

COMPLETE OF THE CRIB WITH GUARD RAIL OPTION

