

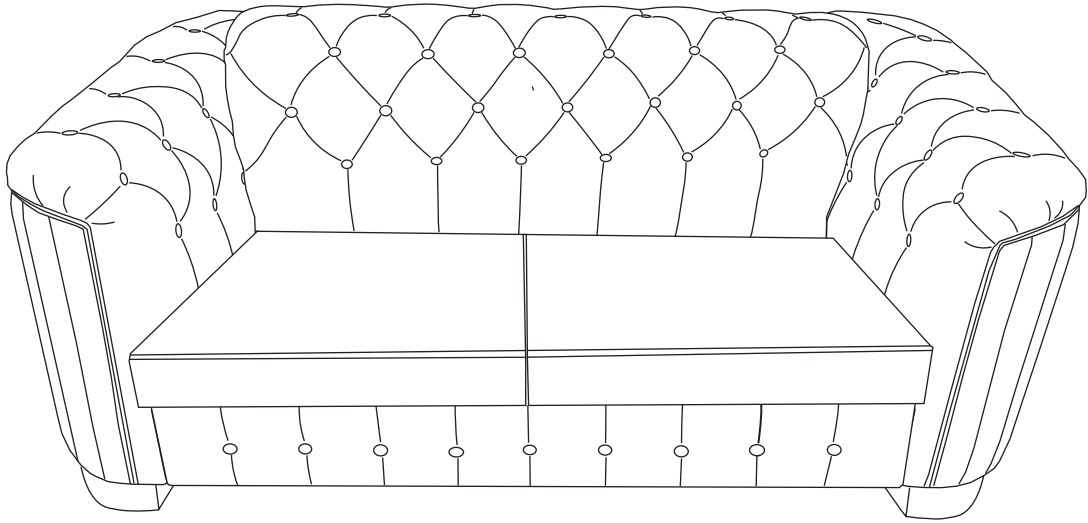

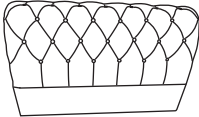

# LOVESEAT

## ASSEMBLY INSTRUCTIONS

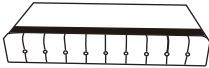
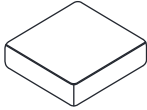

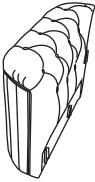
LOVESEAT is packed in 3 cases

Carton	Disignation	Part		Hardware
L1	Backrest	#1		
L2	Seat frame	#2		#A #B #C #D #E
	Cushion	#3		
	Leg	#4		
ARM	Left arm	#5		
	Right arm	#6		

# ASSEMBLY INSTRUCTIONS

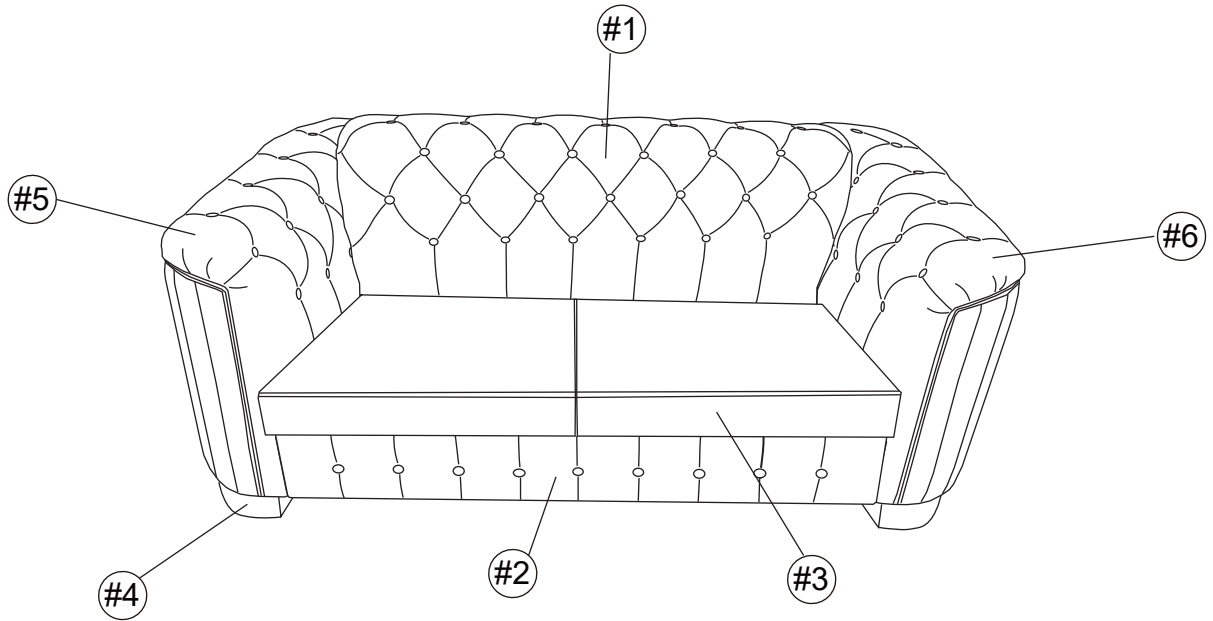

## PARTS

#1 1 pc

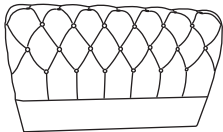

Backrest

#2 1 pc

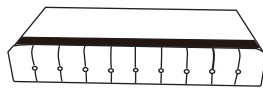

Seat frame

#3 2 pcs

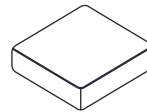

Cushion

#4 4 pcs



Leg

#5 1 pc

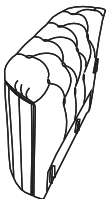

Left arm

#6 1 pc



Right arm

## HARDWARE

#A 4 pcs



BOLT 2-1/2 "L

#B 1 pc



ALLEN KEY 100mm L

#C 4 pcs



FLAT WASHER 16mm

#D 4 pcs



SPRING WASHER

#E 8 pcs



Screw 60mm L

# ASSEMBLY INSTRUCTIONS

---

## STEP1:

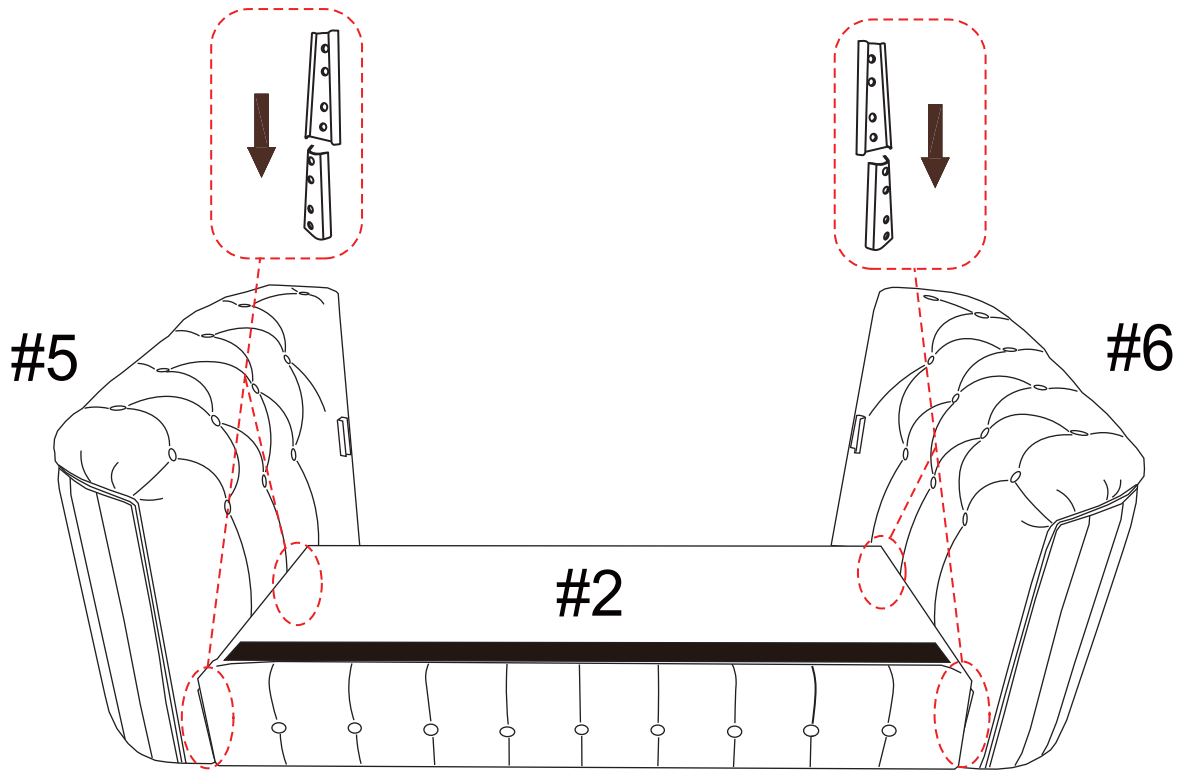

## STEP2:

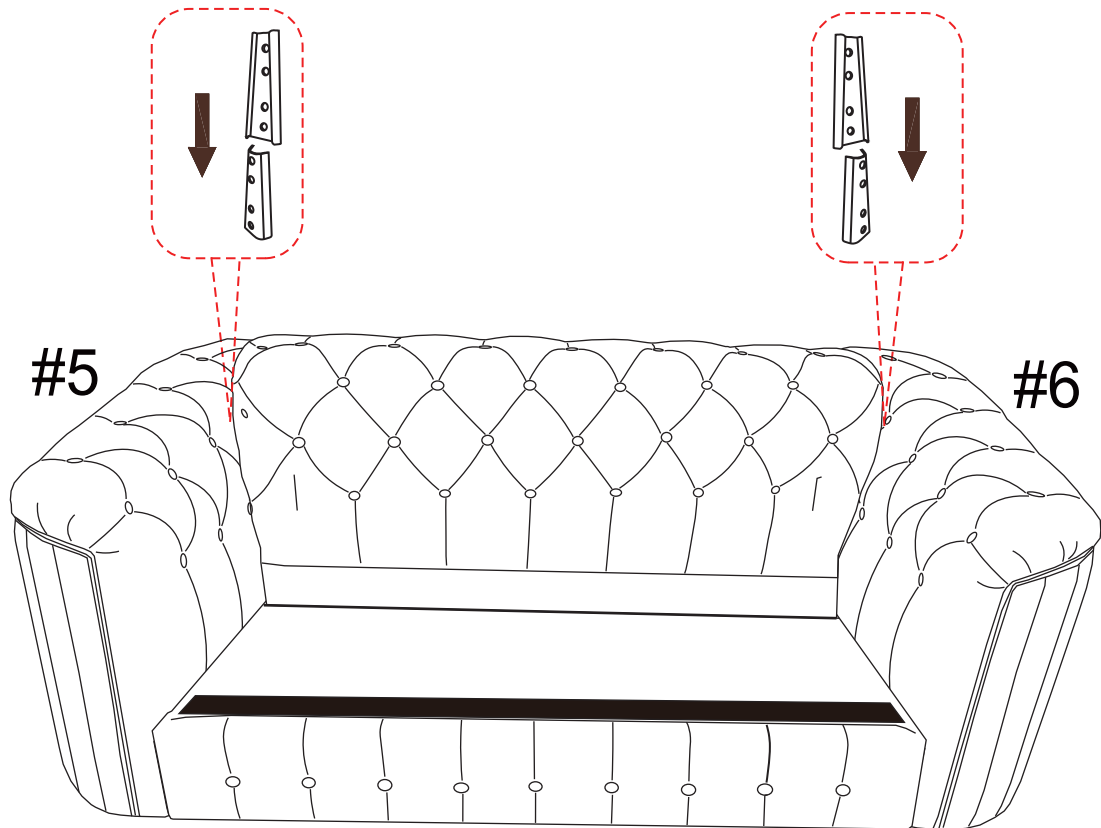

# ASSEMBLY INSTRUCTIONS

## STEP3:

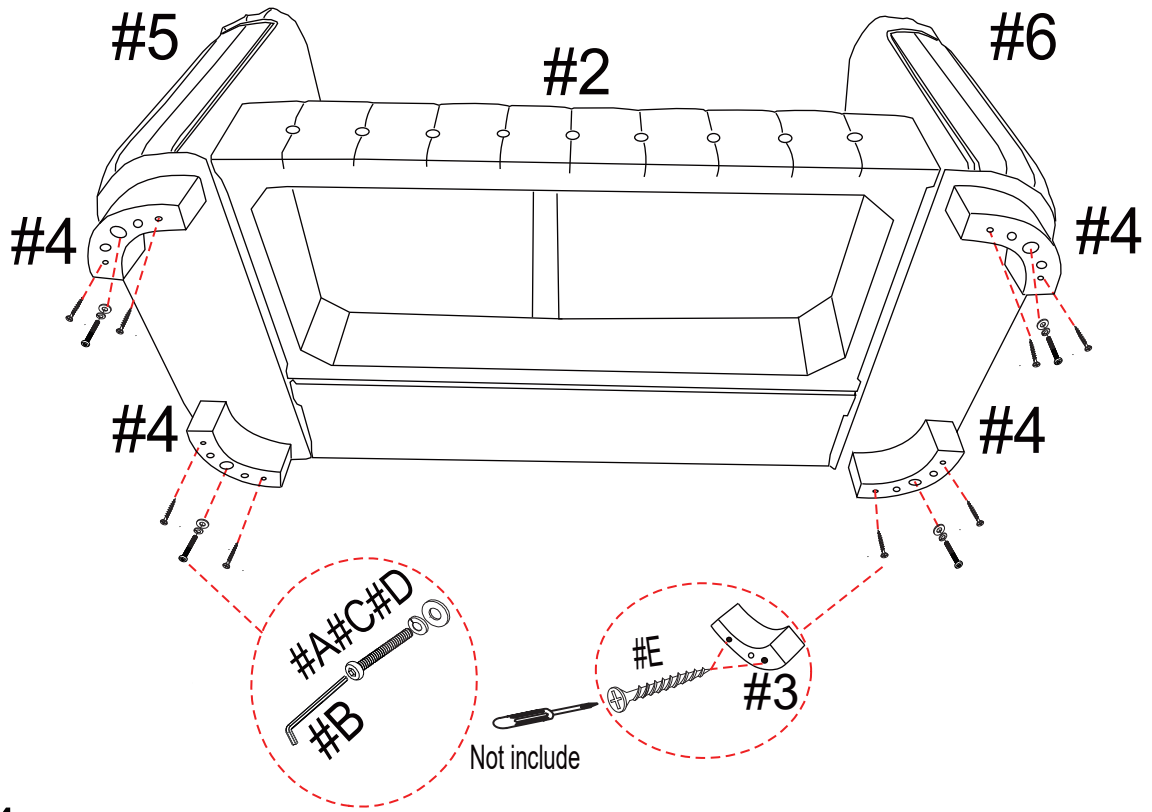

## STEP4:

