

Top View

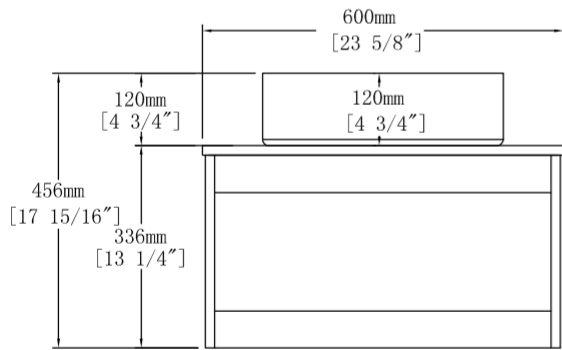

Front View

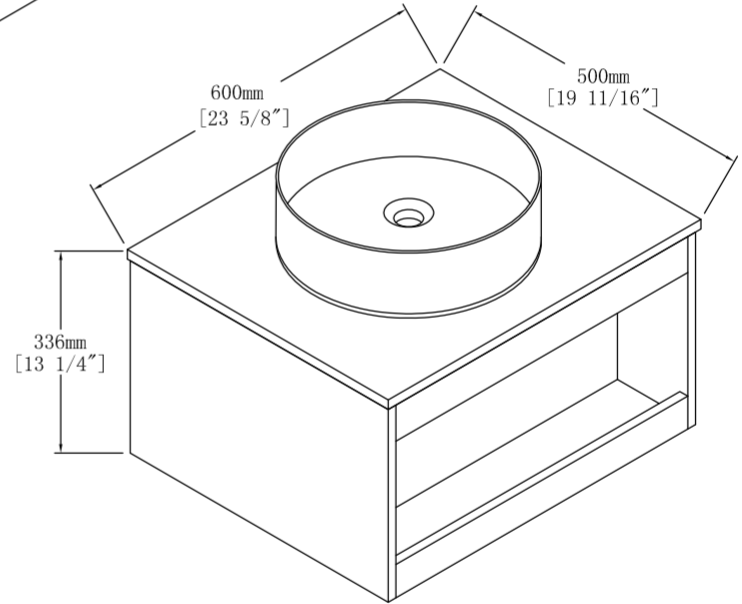
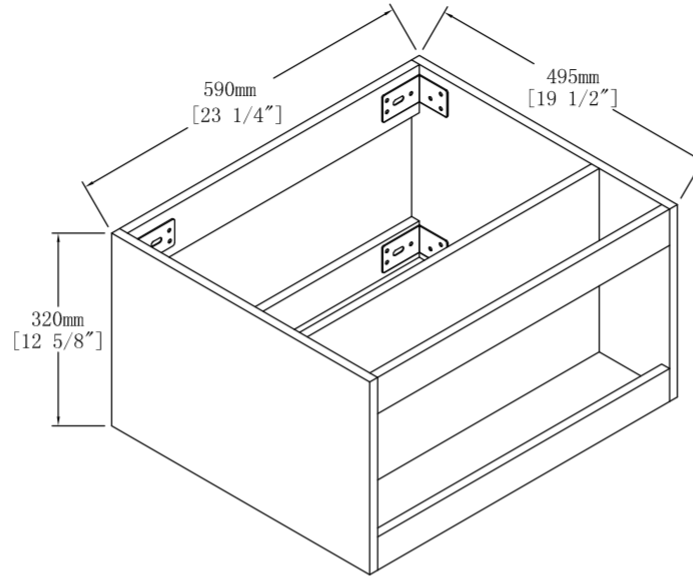
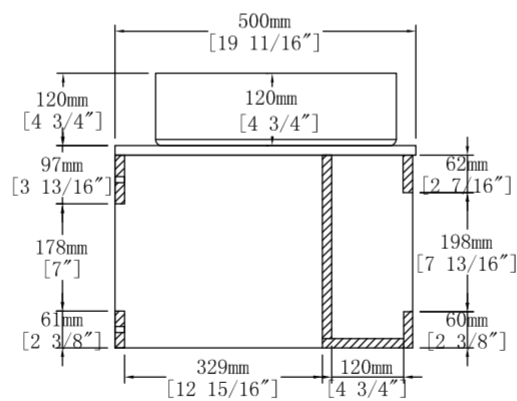

Side View

Item NO.	UNOR V 002 24	Version	V1
Project		Date	2025-11-11