

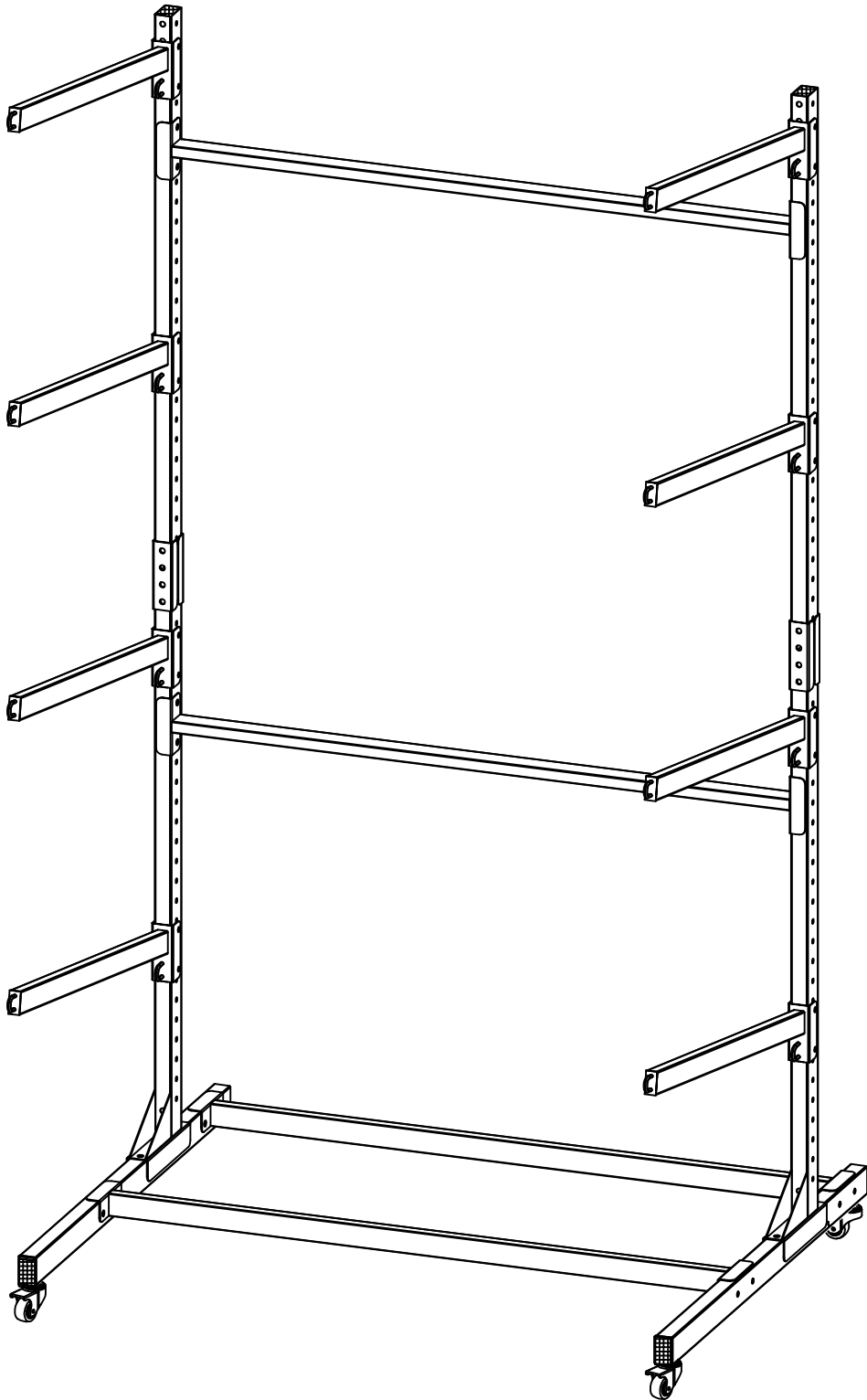

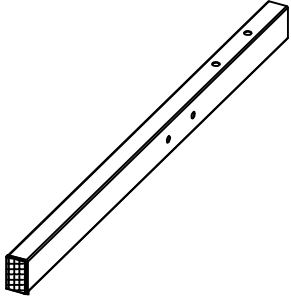

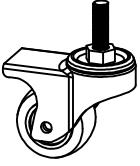

Assembly Instructions

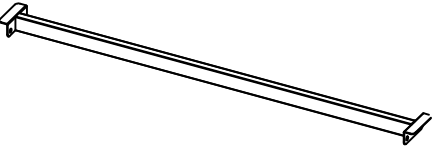

Accessories

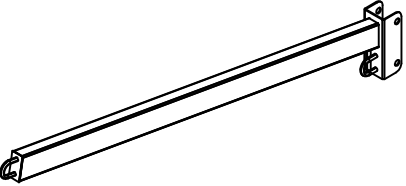
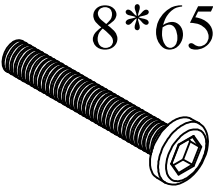
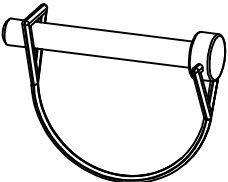
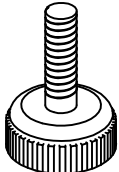
Name	Picture	QTY	Name	Picture	QTY
A		2	M		4
B		2	H		16
D		4	I		28
E		8	J		12
F		16	G		4

Accessories

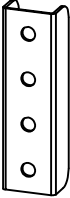
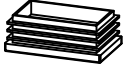
Name	Picture	QTY	Name	Picture	QTY
C		2	L		4
	6	Already attached on part A and B			

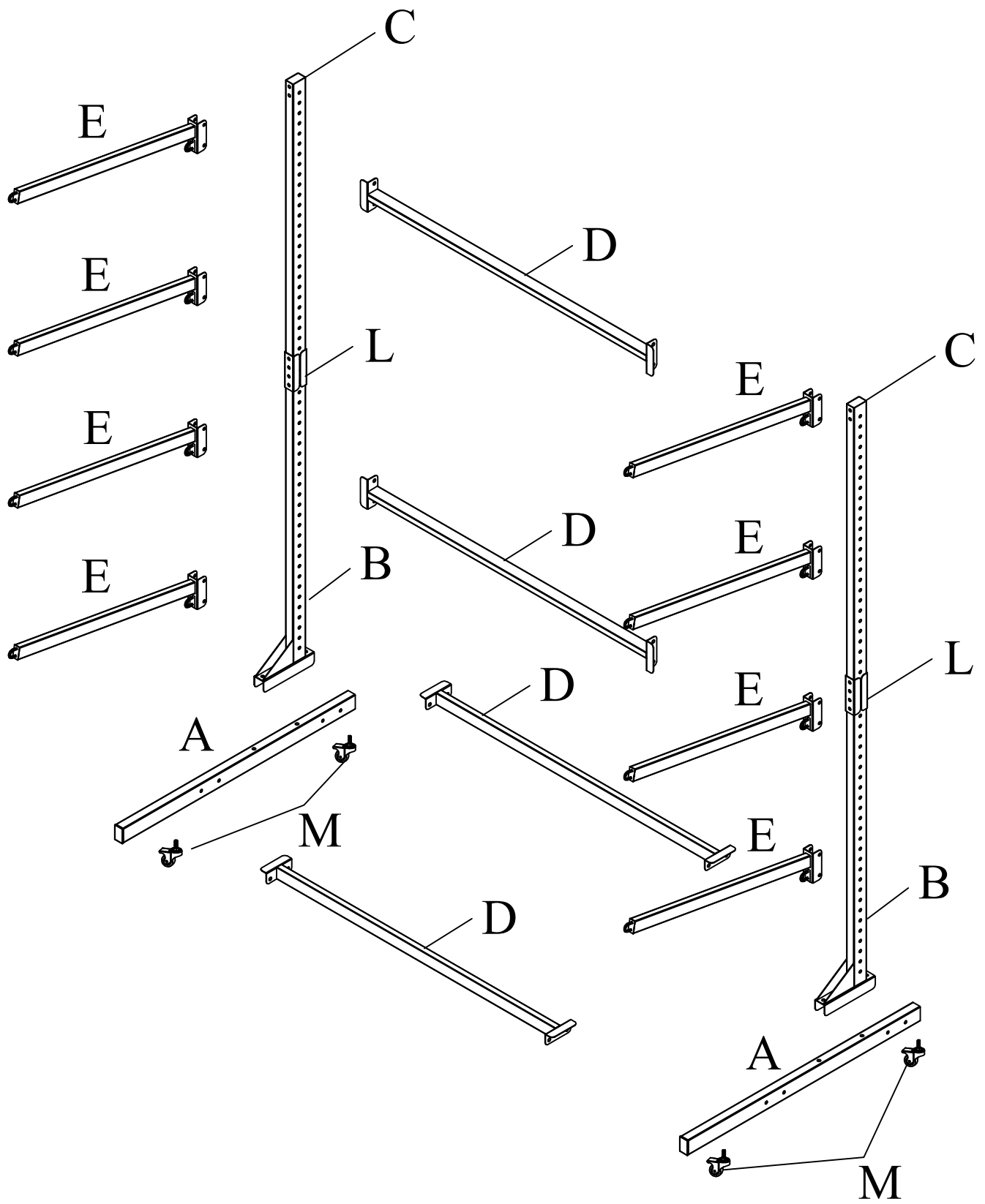

Step 1

Install 4 wheels M or 4 feet G on the bottom of A

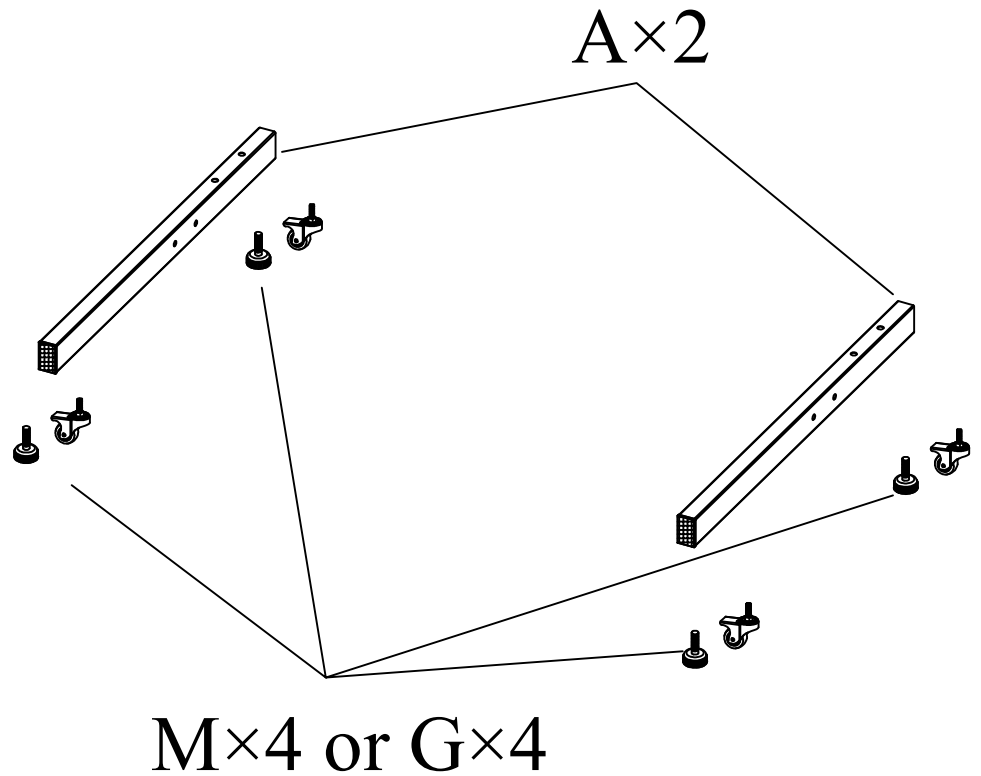

$A \times 2$

$M \times 4$ or $G \times 4$

Step 2

Connect 2 B and 2 C with 4 L by 8 I and 8 J then install them on 2 A with 4 I and 4 J

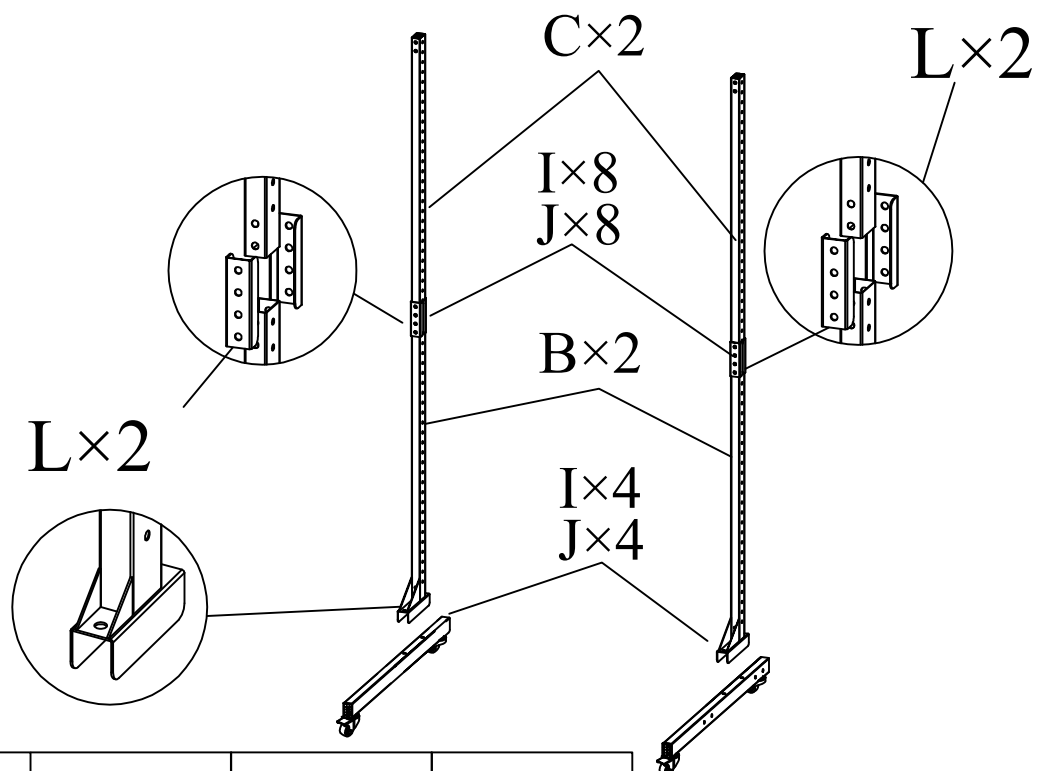

$B \times 2$

$C \times 2$

$L \times 4$

$I \times 12$

$J \times 12$

Step 3

Install 4 D on A and B and fasten them with 16 I and 16 H

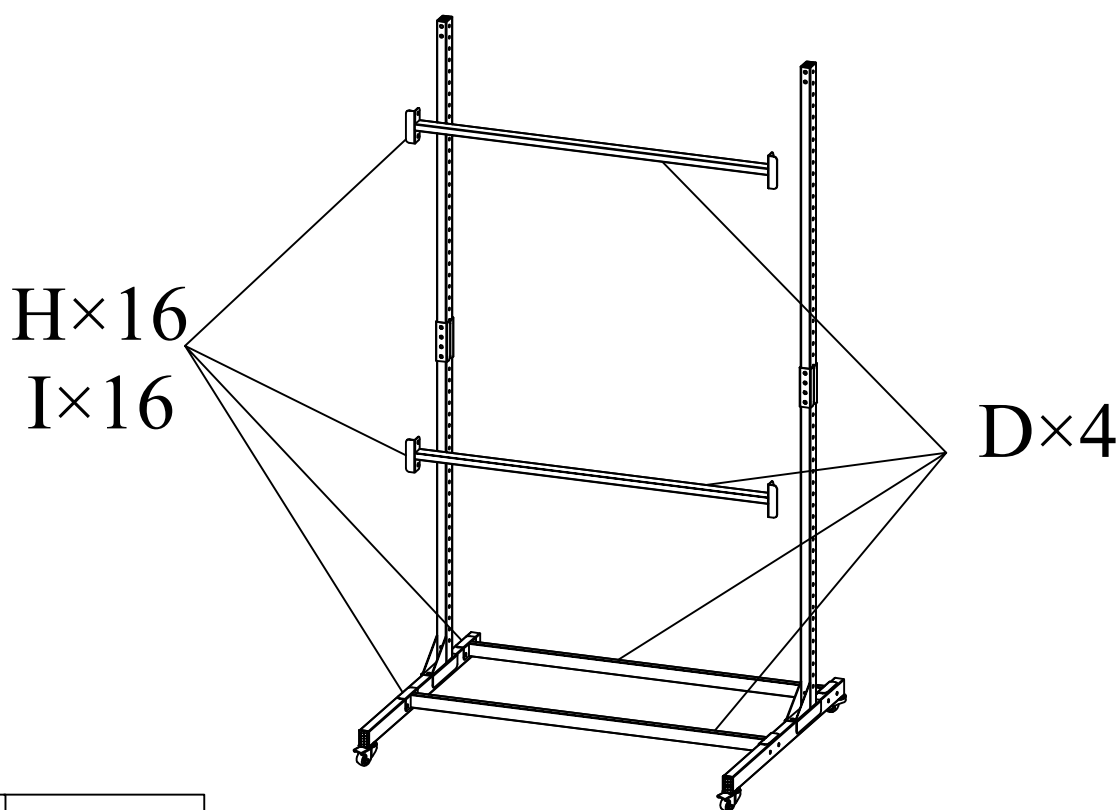

D×4

H×16

I×16

Step 4

Install 8 E on B and fasten them with 16 F

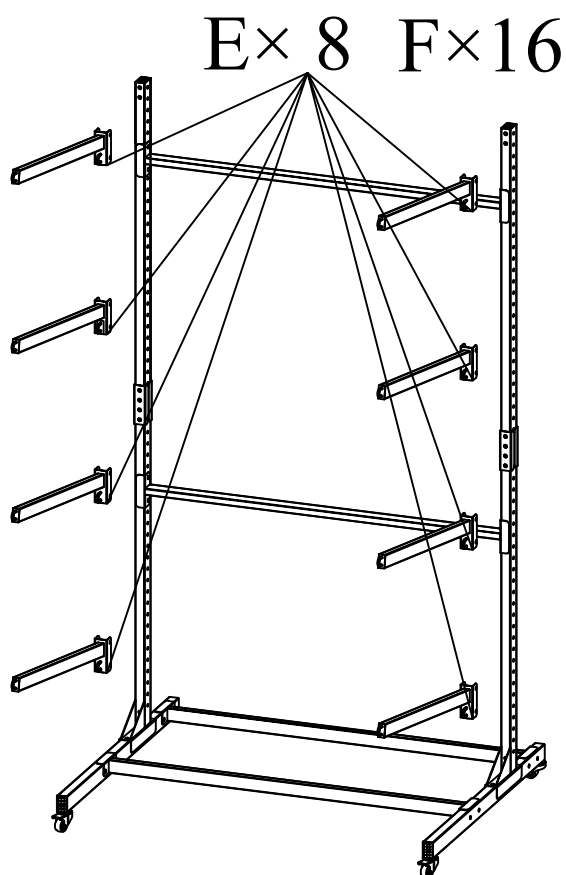

E×8

F×16

