

# LYNTON TABLE

## ASSEMBLY GUIDE

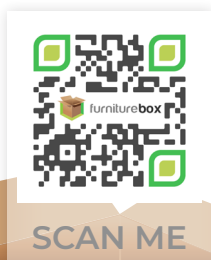
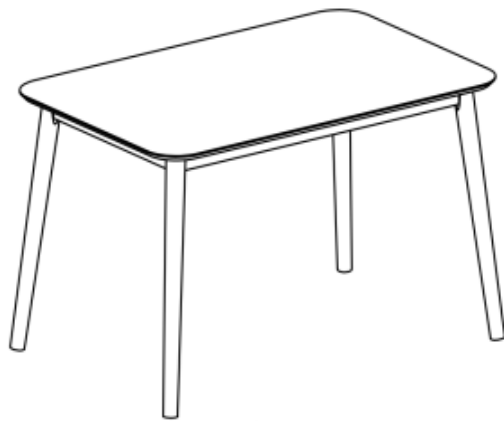

[www.furniturebox.co.uk](http://www.furniturebox.co.uk)

Scan QR code for more tips,  
advice and assembly video or visit  
[furniturebox.co.uk/club/lyntontable](http://furniturebox.co.uk/club/lyntontable)

**Important - Please read these instructions fully before starting assembly**



**SAFETY AND  
CARE ADVICE**



**NO POWER TOOLS**

**SAFETY AND CARE ADVICE**

- Check you have all the components and tools listed.
- Remove all fittings from the plastic bags and separate them into their groups.
- We do not recommend the use of power drills/drivers for inserting screws, as this could damage the unit. Only use hand screwdrivers and Allen keys.
- Keep children and animals away from the work area, small parts could cause choking if swallowed.
- Make sure you have enough space to layout the parts before starting.
- Assemble the item as close to its final position (in the same room) as possible.
- Do not overtighten the nuts to avoid causing damage to the threads.
- Only clean using a damp cloth and mild detergent, do not use bleach or abrasive cleaners.
- From time to time check that there are no loose screws on this unit
- This product should not be discarded with household waste. Take to your local authority waste disposal centre



## IMPORTANT INFORMATION



30 MINUTE  
BUILD







TWO  
PERSON



MAXIMUM  
CAPACITY  
Small 40KG, Large 60KG

PLEASE CHECK CAREFULLY AND MAKE SURE YOU HAVE ALL FITTINGS AND TOOLS LISTED BELOW BEFORE YOU START.

LIST OF PARTS		
No	Description	Qty
1	Table Top	1
2	Table Legs	4

LIST OF PARTS		
No	Description	Qty
A	Jcbc 	8
B	Spring washer 	8
C	Flat washer 	8
D	Allen Key 	1

**NOTE:** The quantities above are the correct amount to complete the assembly. In some cases more fittings may be supplied than are required.

## STEP 1

Use a clean, flat, soft surface to avoid any bumps or scratches.

Place table top [1] face down on your flat surface.

Attach 4x table legs [2] - align the pre-drilled holes and connect using 2x flat washers [C] + 2x spring washers [B] + 2x bolts [A] per leg - 8 in total. Tighten with Allen key [D] but avoid over-tightening.

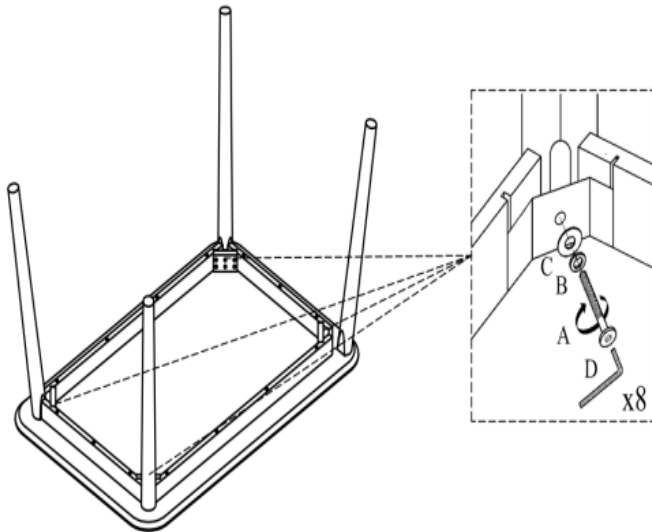

## STEP 2

Carefully flip your table upright onto its legs. Check for stability. Your new table is now ready to use.

