

Before You Start

Thank you for purchasing our product. Please read this instruction manual carefully before attempting to install.

- It is very important to ensure each step followed in correct order, otherwise assembly difficulties may occur.
- Retain instructions for future reference.
- Separate and count all parts and hardware.
- We recommend that, where possible, all items are assembled near to the area in which they will be placed in use, to avoid moving the product unnecessarily once assembled.
- Always place the product on a flat, steady and stable surface.

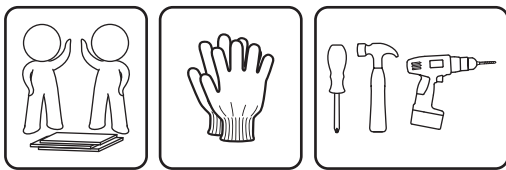

18UDBF01
19UDBF01

ENGLISH

General Guidelines

1. Please read the following instructions carefully and use the product accordingly.
2. Please keep this manual and hand it over when you transfer the product.
3. This summary may not include every detail of all variations and considered steps.
Please contact us when further information and help are needed.

Warnings

1. Children are not allowed to assemble the product. During assembly, keep small parts out of the reach of children as they may be fatal if swallowed or inhaled.
2. Children are not allowed to climb or stand on the product to avoid personal injury caused by the toppling.
3. Keep plastic packing bags out of reach of children to avoid any potential danger, such as suffocation.
4. Avoid sharp objects and corrosive chemicals to prevent damage to the product or the user.
5. Please do not use the product if there is/are defective and/or missing part/s, as this can result in damage or injury.

Notes

1. The item is only intended for indoor use. Personal injury and/or damage to the product may occur if products are used outside of their intended purposes and/or if products have been changed/modified from their original design. The product must be assembled and used in accordance with the provisions of the manual. The seller does not assume any responsibility or liability with respect to any damage caused by incorrect assembly or improper use.
2. Do not place it in a damp environment for extended periods of time to prevent mildew.
3. During assembly, first loosely align all screws with the corresponding pre-drilled holes and then tighten the screws one by one.
4. Periodically inspect screw tightness while the product is in use. If necessary, re-tighten to ensure structural integrity.
5. The total power of the connected electrical appliances shall not exceed the rated power of the socket.
6. When using, try to stretch the wires as much as possible and do not bundle them to avoid abnormal overheating.
7. When using, please fully insert the electrical plug and keep the wires in full contact to prevent electric shock accidents.
8. Prohibit the serial use of plug connections.
9. It is prohibited to use the plug in damp places and the product should be kept dry.
10. Do not cover the top of the product with any objects during use to prevent overheating and causing a fire.

11. If there are any abnormalities such as damaged wires or exposed metal on the product, please stop using it immediately.

DEUTSCH

Einleitung

1. Bitte lesen Sie die folgende Anleitung aufmerksam durch und verwenden Sie das Produkt sachgemäß.
2. Bewahren Sie diese Anleitung gut auf und händigen Sie sie bei Weitergabe des Produkts an Dritte ebenfalls mit aus.
3. Aus Gründen der Übersicht können nicht alle Details zu allen Varianten und denkbaren Montagen beschrieben werden. Wenn Sie weitere Informationen und Hilfe benötigen, kontaktieren Sie uns bitte.

Warnhinweise

1. Halten Sie Kinder während der Montage vom Arbeitsbereich fern. Zum Lieferumfang gehören viele Kleinteile, die beim Verschlucken oder Inhalieren lebensgefährlich sein können.
2. Um durch Umkippen verursachte Verletzungen zu vermeiden, dürfen sich Kinder unter keinen Umständen auf das Produkt stellen, auf dieses klettern oder damit spielen.
3. Verwahren Sie Verpackungsteile nur an Orten, die Kindern, insbesondere Säuglingen, nicht zugänglich sind. Verpackungsteile bergen oftmals nicht erkennbare Gefahren (z.B. Erstickungsgefahr).
4. Das Produkt darf nicht mit scharfen Gegenständen und aggressiven chemischen Substanzen in Kontakt kommen, um Beschädigungen zu vermeiden.
5. Verwenden Sie das Produkt bitte nicht, wenn Teile fehlen oder defekt sind.

Hinweise

1. Das Produkt ist zum Gebrauch in Innenräumen vorgesehen. Montieren und verwenden Sie das Produkt nur wie in dieser Anleitung beschrieben. Eine andere Verwendung oder eine Veränderung/ein Umbau des Produktes ist nicht erlaubt und kann zu Verletzungen und/oder Beschädigungen des Produktes führen. Der Händler übernimmt keine Haftung für Schäden, die durch unsachgemäßen Gebrauch oder falsche Montage entstanden sind.

2. Stellen Sie das Produkt bitte nicht über einen längeren Zeitraum in einer feuchten Umgebung auf, um Schimmel zu vermeiden.
3. Ziehen Sie die Schrauben bei der Montage bitte nicht sofort an. Erst nachdem Sie alle Schrauben in die vorgebohrten Öffnungen eingesetzt haben, sollten Sie diese vorsichtig festziehen.
4. Prüfen Sie regelmäßig den festen Sitz der Schrauben, denn diese können sich mit der Zeit lösen, was zum Umkippen des Produktes führen könnte. Falls notwendig, sollten Sie die Schrauben nachziehen.
5. Die Gesamtleistung der angeschlossenen Elektrogeräte darf die Nennleistung der Steckdosenleiste nicht überschreiten;
6. Versuchen Sie bei der Verwendung, die Drähte so weit wie möglich zu dehnen, und bündeln Sie sie nicht, um eine ungewöhnliche Überhitzung zu vermeiden.
7. Bitte stecken Sie bei der Verwendung den Stecker des Elektrogeräts vollständig in die Steckdose und halten Sie die Drähte in vollem Kontakt, um Unfälle durch Stromschläge zu vermeiden.
8. Die Reihenschaltung von Steckdosenleisten ist untersagt;
9. Es ist verboten, die Steckdosenleiste in einer feuchten Umgebung zu verwenden und das Produkt muss trocken gehalten werden;
10. Es ist verboten, das Produkt während des Gebrauchs mit Gegenständen abzudecken, um eine Überhitzung des Produkts und die Entstehung eines Brandes zu verhindern.
11. Wenn das Produkt ungewöhnliche Erscheinungen wie beschädigte Drähte oder freiliegendes Metall aufweist, stellen Sie die Verwendung sofort ein.

FRANÇAIS

Introduction

1. Lisez attentivement ces instructions et utilisez votre produit d'après ce mode d'emploi.
2. Conservez ces instructions. Si vous souhaitez offrir ce produit à la troisième partie, joignez obligatoirement ce mode d'emploi.
3. Cette instruction ne peut pas inclure tous les détails de toutes les variations et étapes envisagées. Si vous souhaitez obtenir plus d'informations ou si vous rencontrez certains problèmes non traités de manière détaillée dans ces instructions, veuillez nous contacter.

Avertissements

1. Gardez toutes les pièces hors de la portée des enfants, il peut être mortel en cas d'ingestion ou d'inhalation.
2. Il est interdit aux enfants de monter sur le produit ou de jouer avec. Le renversement du produit causerait des accidents, avec des risques plus ou moins graves.
3. Pour éviter les dangers potentiels (par exemple les étouffements), gardez les emballages (films, sacs plastiques, polystyrènes, etc.) hors de la portée des enfants.
4. Évitez tout contact avec des objets pointus et des produits chimiques corrosifs.
5. N'utilisez jamais ce produit dans le cas de manque ou défectuosité des pièces pour éviter le danger potentiel.

Notes

1. Le produit est destiné uniquement à un usage intérieur. Il doit être assemblé et utilisé conformément aux instructions. Les utilisations qui ne correspondent pas à la description ci-dessus ou les transformations de l'article ne sont pas autorisées. Le vendeur ne prend aucune responsabilité aux dommages causés par un montage incorrect ou une utilisation non conforme.
2. Ne placez pas le produit dans un environnement à humidité élevée afin d'éviter le développement des moisissures.
3. Veuillez d'abord positionner et régler les pièces en faisant référence à la notice de montage, puis effectuer un serrage progressif.
4. Vérifiez régulièrement le serrage des vis. En cas de nécessité, resserrez les resserrez.
5. La puissance totale des appareils électriques raccordés ne doit en aucun cas excéder la puissance nominale de la fiche.
6. Essayez d'étirer les fils lors de l'utilisation, évitez de les attacher, afin de prévenir toute surchauffe anormale.
7. Lors de l'utilisation, assurez-vous d'insérer complètement la fiche électrique et de maintenir les fils en contact dans le but d'éviter tout risque d'électrocution.
8. Il est strictement interdit d'utiliser cette multiprise en tandem, en la branchant à une autre multiprise.
9. N'utilisez en aucun cas des fiches et des prises dans des environnements humides, gardez toujours le produit au sec.
10. Ne recouvrez pas la partie supérieure du produit pendant son utilisation pour éviter tout risque de surchauffe et d'incendie.
11. Si le produit présente des signes d'anomalie tels que des fils endommagés ou du métal exposé, arrêtez immédiatement de l'utiliser.

ITALIANO

Linee Guida Generali

1. Si prega di leggere attentamente le seguenti istruzioni e usare il prodotto in modo opportuno.
2. Si prega di conservare questo manuale e consegnarlo quando il prodotto cambia proprietario.
3. Questo riassunto potrebbe non includere ogni dettaglio di tutte le variazioni e le fasi considerate. Contattaci se hai bisogno di ulteriori informazioni e assistenza.

Avvertenze

1. I bambini non sono autorizzati a montare il prodotto. Durante l'assemblaggio, si raccomanda di tenere i bambini a debita distanza, in quanto alcune parti di piccole dimensioni potrebbero essere ingerite con conseguenze dannose per la salute.
2. I bambini non sono autorizzati a stare in piedi, arrampicarsi o giocare sul prodotto per evitare gravi lesioni fisiche a causa del ribaltamento.
3. Tenere gli imballaggi di plastica fuori dalla portata dei bambini per evitare potenziali pericoli come soffocamento.
4. Evitare l'utilizzo di oggetti taglienti e sostanze chimiche corrosive per prevenire danni al prodotto o lesioni personali.
5. Si prega di non utilizzare il prodotto in caso di parti difettose e/o mancanti, in quanto ciò può causare danni lesioni.

Note

1. Il prodotto è inteso per uso interno. Si prega di seguire attentamente le istruzioni per montare e usare il prodotto. L'uso non conforme alla descrizione, o cambio o modifica non autorizzata del prodotto, non è consentito e può provocare lesioni e/o danni al prodotto.
Il venditore non si assume alcuna responsabilità per danni o lesioni derivanti da montaggio o uso impropri.
2. Evitare l'esposizione a lungo termine in ambienti umidi per evitare la formazione di muffe.
3. Non stringere completamente le viti fino a quando tutte le viti sono allineate con i fori preforati corrispondenti.
4. Controllare regolarmente le viti. Poiché le viti possono allentarsi durante l'uso prolungato. Se necessario, riavvitarle per garantire stabilità e sicurezza.
5. La potenza totale degli apparecchi elettrici collegati non deve superare la potenza nominale della ciabatta elettrica.
6. Cercare di stendere il cavo durante l'uso, non avvolgerlo, in modo da evitare il surriscaldamento.

7. Cuando se utiliza, insertar completamente la espina eléctrica y mantener el contacto completamente a contacto para evitar el verificarse de scoses eléctricas.
8. No utilizar la ciabatta eléctrica en serie con otra ciabatta eléctrica.
9. No utilizar la ciabatta eléctrica en lugares húmedos y mantener el producto seco.
10. La parte superior del producto no debe estar cubierta por otras cosas, de modo de evitar el sobrecalentamiento y el riesgo de incendio.
11. Si el producto presenta fenómenos anómalos como cables dañados y metal expuesto, interrumpir inmediatamente el uso.

ESPAÑOL

Acerca del manual

1. Por favor, lea detenidamente las instrucciones y respete los usos debidos del producto.
2. Por favor, conserve bien este manual y en caso de cesión, no omita entregarlo junto al producto.
3. Este manual podría no incluir todos los detalles de cada paso del montaje. Si necesita ayuda o información adicional, póngase en contacto con nosotros.

Advertencias

1. Los niños no están autorizados a montar el producto. Durante el montaje, mantenga las piezas pequeñas fuera del alcance de los niños, ya que pueden ser mortales si se ingieren o inhalan.
2. No se permite que los niños se suban o se suban al producto para evitar lesiones personales causadas por el vuelco.
3. Mantenga las bolsas de plástico fuera del alcance de los niños para evitar cualquier peligro potencial, como la asfixia.
4. Evite los objetos punzantes y los productos químicos corrosivos para evitar daños al producto o al usuario.
5. Por favor, no utilice el producto si está defectuoso y/o le faltan piezas, ya que esto puede ocasionar daños o lesiones.



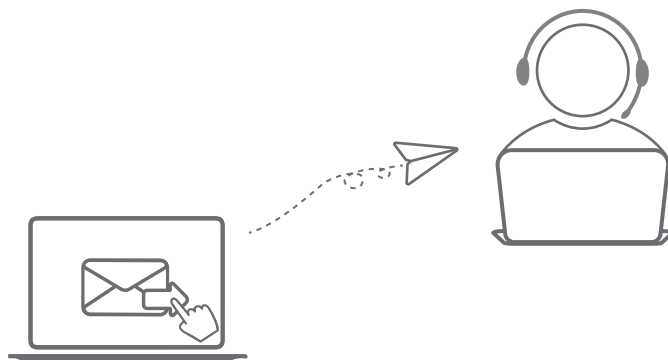
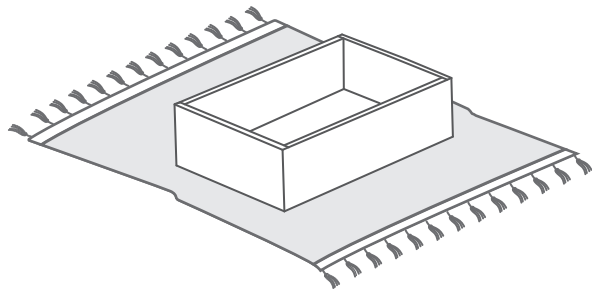

Notas

1. El artículo sólo está destinado a ser utilizado en interiores. Pueden ocurrir lesiones personales y/o daños al producto si los productos se utilizan fuera de su uso previsto y/o si los productos han sido cambiados/modificados de su diseño original. El producto debe ser montado y utilizado de acuerdo con las disposiciones del manual. El vendedor no asume ninguna responsabilidad con respecto a cualquier daño causado por un montaje incorrecto o un uso inadecuado.
2. No lo coloque en un ambiente húmedo por largos períodos de tiempo para prevenir el moho.
3. Durante el montaje, alinee primero todos los tornillos con los orificios pretaladrados correspondientes y, a continuación, apriete los tornillos uno por uno.
4. Inspeccione periódicamente el apriete de los tornillos mientras el producto está en uso. Si es necesario, vuelva a apretar para asegurar la integridad estructural.
5. La potencia combinada de los aparatos eléctricos conectados no debe superar la potencia nominal del enchufe.
6. Extienda totalmente los cables durante su uso, no los enrolle o ate para evitar sobrecalentamientos anormales.
7. Introduzca completamente el enchufe del aparato eléctrico al utilizarlo, y mantenga los cables completamente conectados para evitar que se produzcan descargas eléctricas.
8. Se prohíbe el uso de clavijas conectadas a otras en serie.
9. Se prohíbe el uso de enchufes en lugares húmedos, es necesario mantener siempre seco el dispositivo.
10. No cubrir el dispositivo con objetos cuando esté en uso para evitar un incendio causado por el sobrecalentamiento.
11. Si el producto presenta anomalías, como cables rotos o piezas metálicas expuestas, deje de utilizarlo inmediatamente.



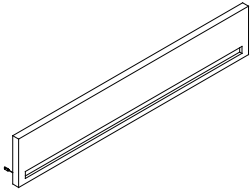

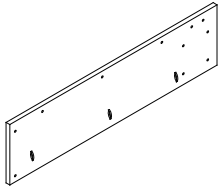
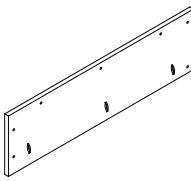
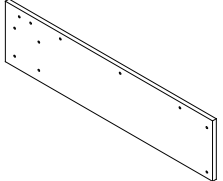
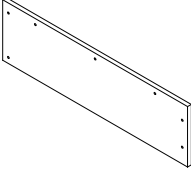
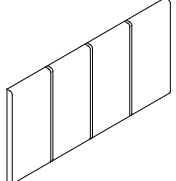
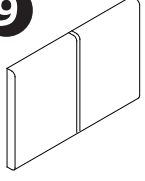
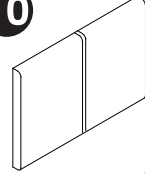
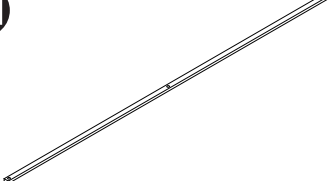
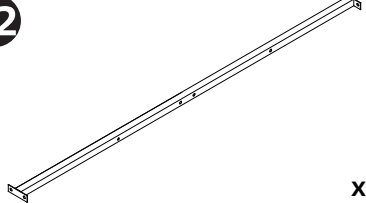
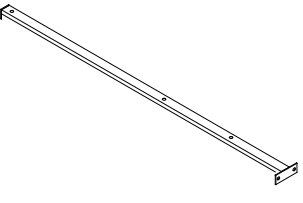
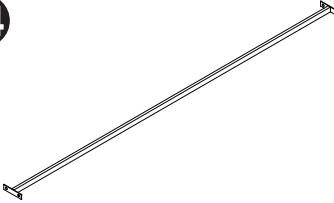
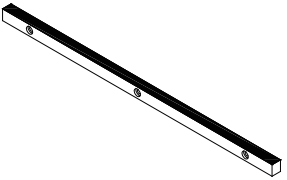
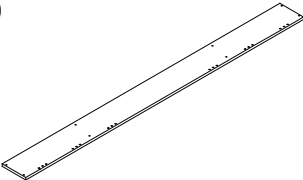
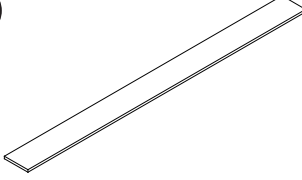
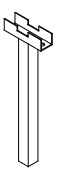
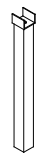
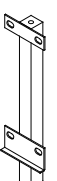
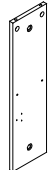
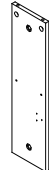
ATTENTION

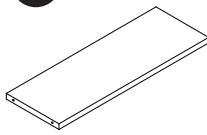
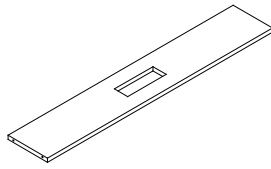
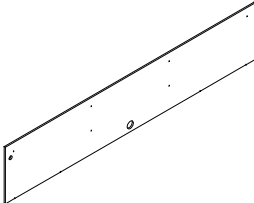
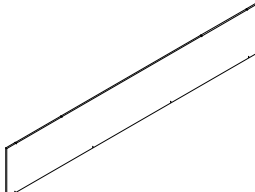
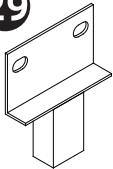
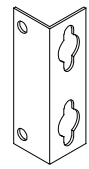
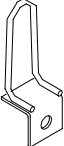
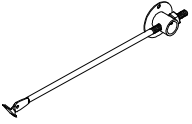



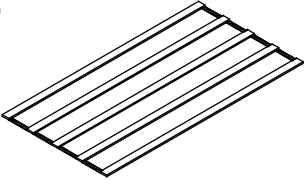
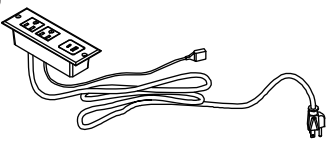

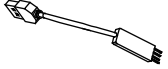
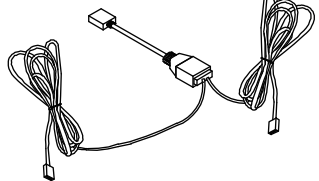

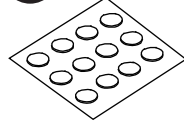
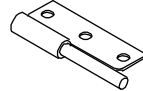
PARTS LIST

1  x 1	2  x 1	3  x 1	4  x 1		
5  x 1	6  x 1	7  x 1			
8  x 1	9  x 1	10  x 1	11  x 1		
12  x 1	13  x 2	14  x 1			
15  x 4	16  x 1	17  x 1			
18  x 1	19  x 2	20  x 2	21  x 1	22  x 1	23  x 1
24  x 1	25  x 2	26  x 1	27  x 1		
28  x 1	29  x 2	30  x 2	31  x 2	32  x 4	

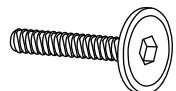
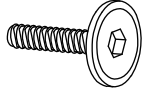
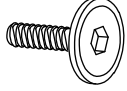
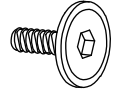
PARTS LIST

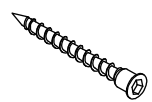
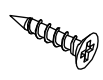
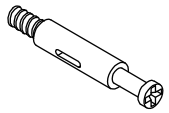
<p>33</p>  <p>x 2</p>	<p>34</p>  <p>x 1</p>	<p>35</p>  <p>x 1</p>	<p>36</p>  <p>x 1</p>	
<p>37</p>  <p>x 1</p>	<p>38</p>  <p>x 1</p>	<p>39</p>  <p>x 12</p>	<p>40</p>  <p>x 6</p>	

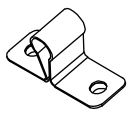
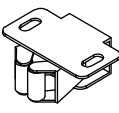
HARDWARE LIST

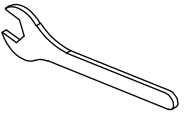
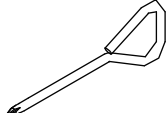
<p>Ax7PCS</p>  <p>5/16X45mm</p>	<p>Bx20+2 PCS</p>  <p>5/16X30mm</p>	<p>Cx12+1 PCS</p>  <p>5/16X25mm</p>	<p>Dx26+2 PCS</p>  <p>5/16X15mm</p>	<p>Ex2 PCS</p>  <p>φ19X5/16</p>
<p>Fx4 PCS</p>  <p>Ø16X1/4</p>	<p>Gx38+3 PCS</p> 	<p>Hx52+4 PCS</p>  <p>M4*12mm</p>	<p>Jx8 PCS</p> 	<p>Kx8 PCS</p> 
<p>Lx2 PCS</p> 	<p>Mx3 PCS</p> 	<p>Nx3 PCS</p> 	<p>Px1 PC</p>  <p>5/16</p>	<p>Qx1 PC</p>  <p>1/4</p>
<p>Rx1 PC</p> 	<p>Sx1 PC</p> 			

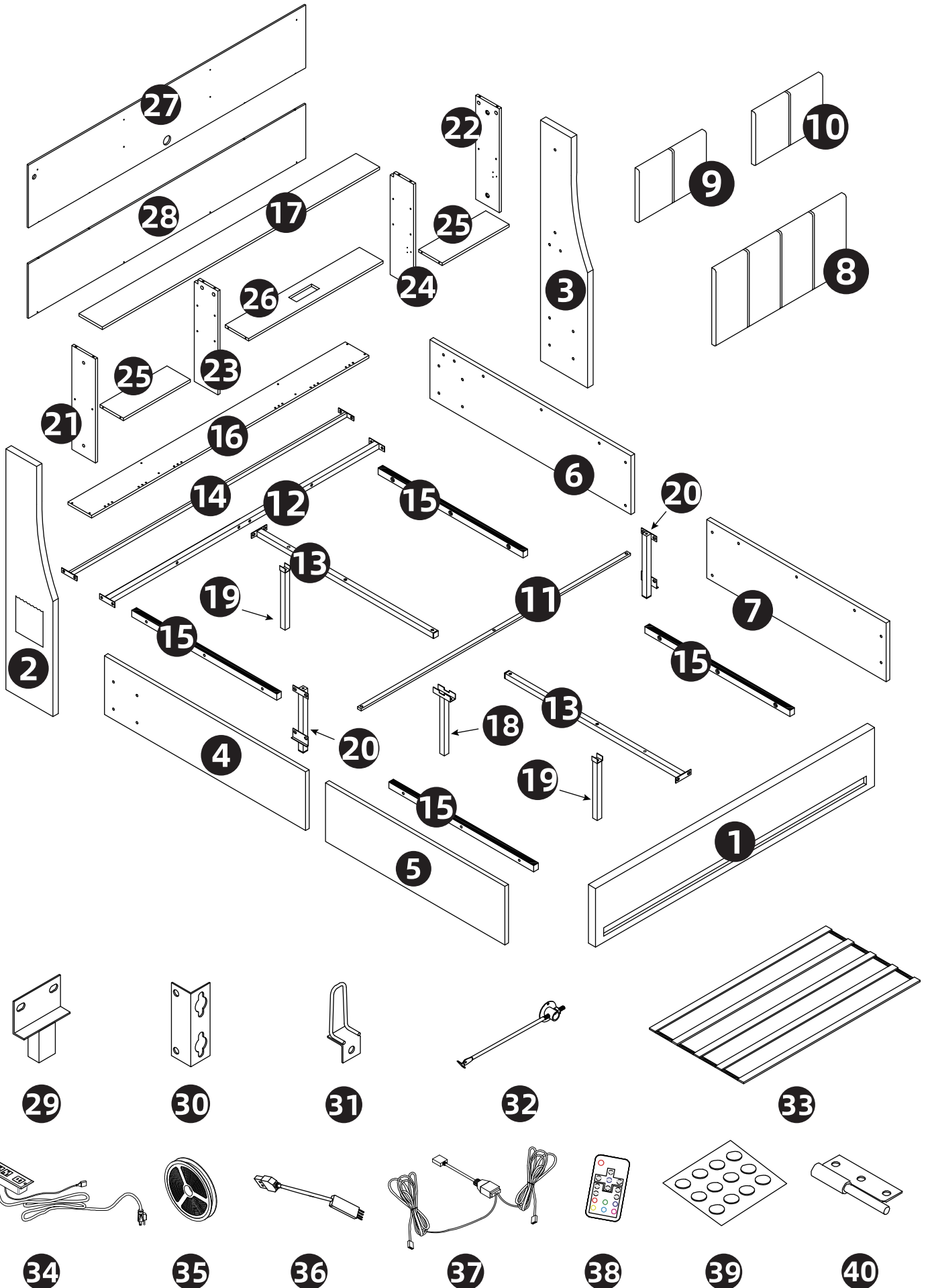

EXPLODED



1 ATTENTION

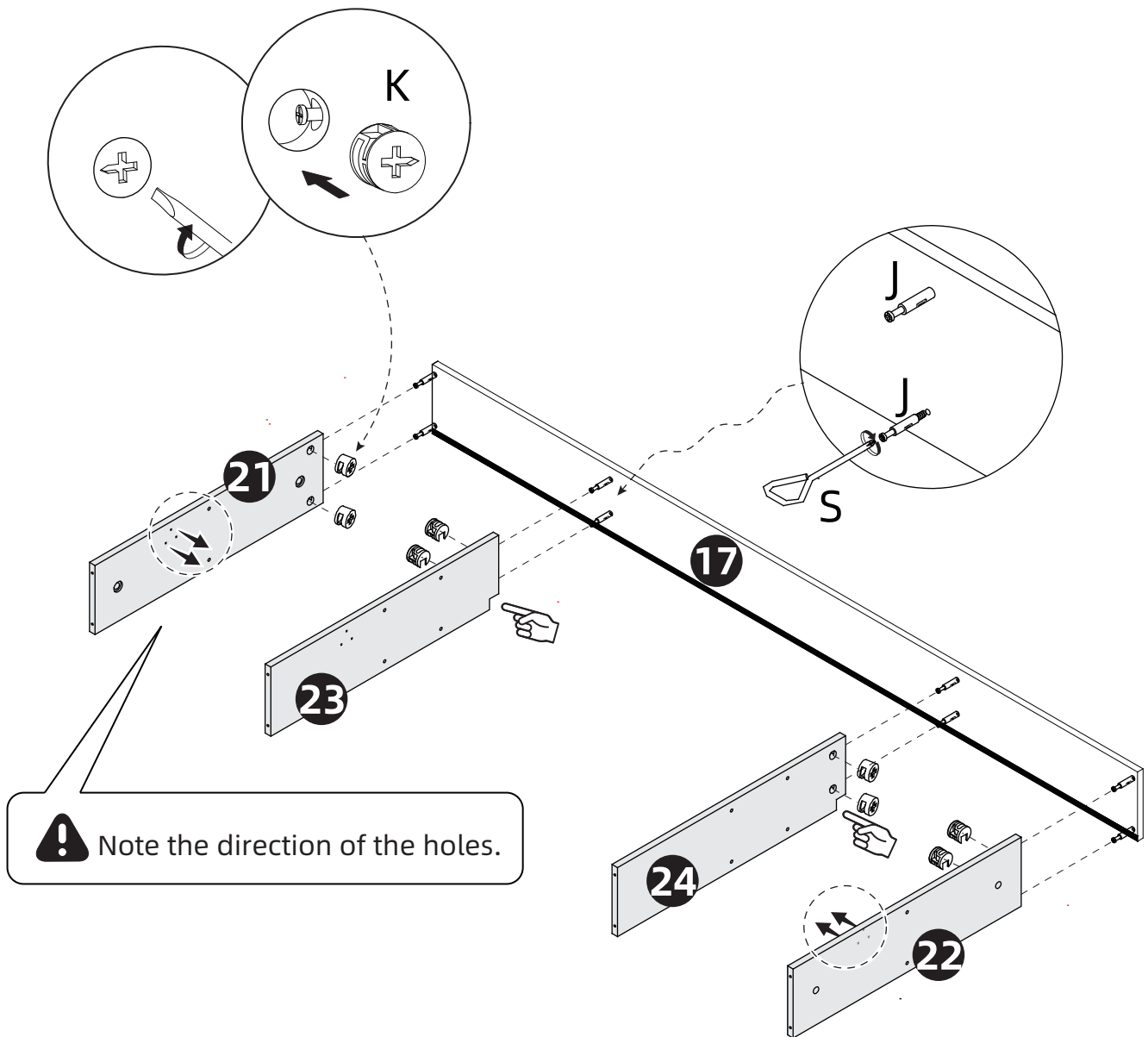

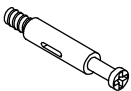
- During assembly, first loosely align all screws with the corresponding pre-drilled holes and then tighten the screws one by one.
- Note: It is recommended to complete the assembly on flat ground or carpet.

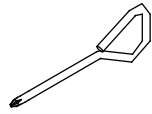

J X 8	K X 8	S X 1
		

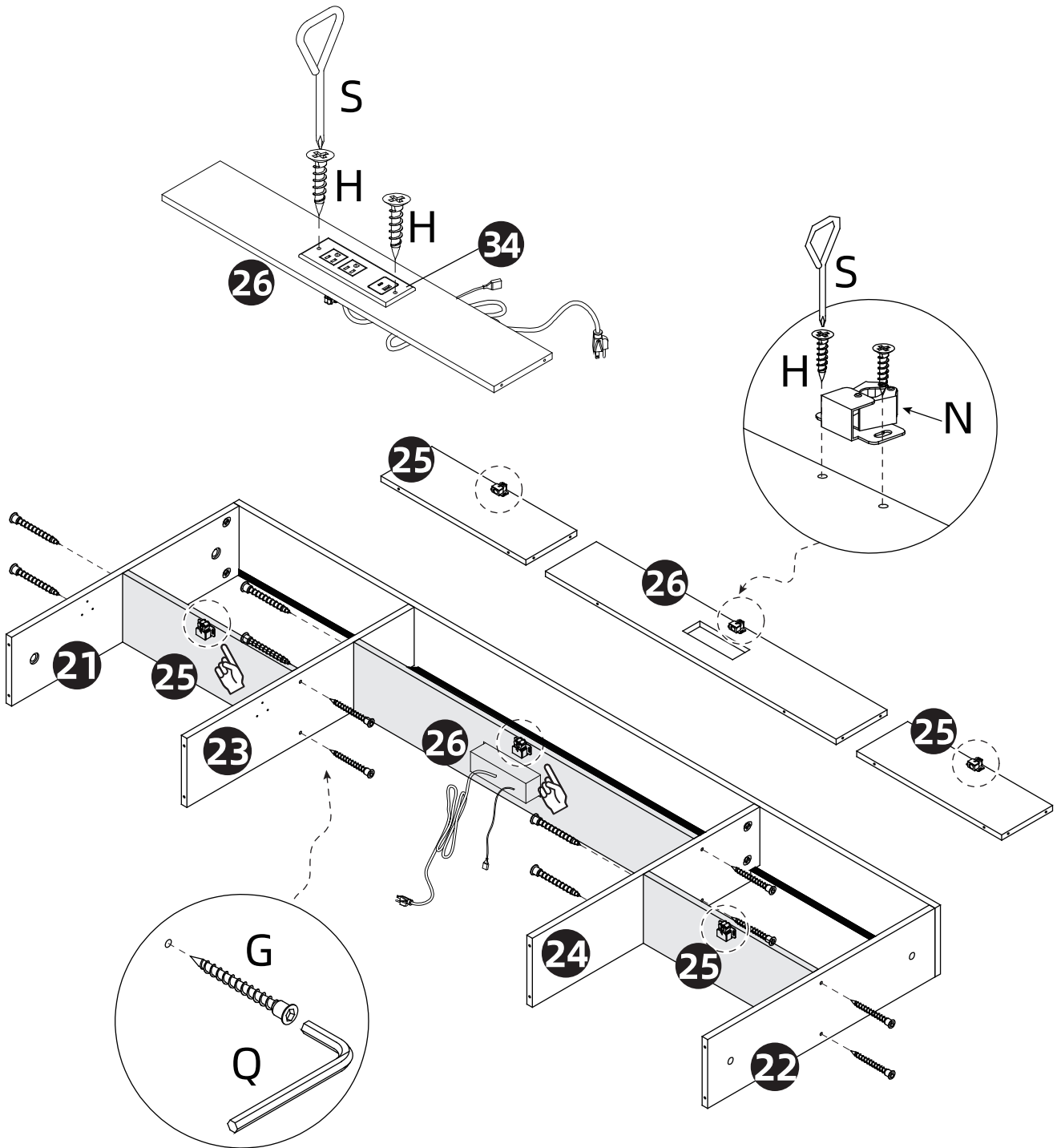
2

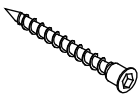
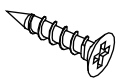
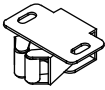
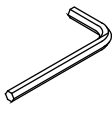
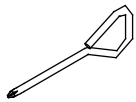

G X 12	H X 8	N X 3	Q X 1	S X 1	34 x 1
			 1/4		

3

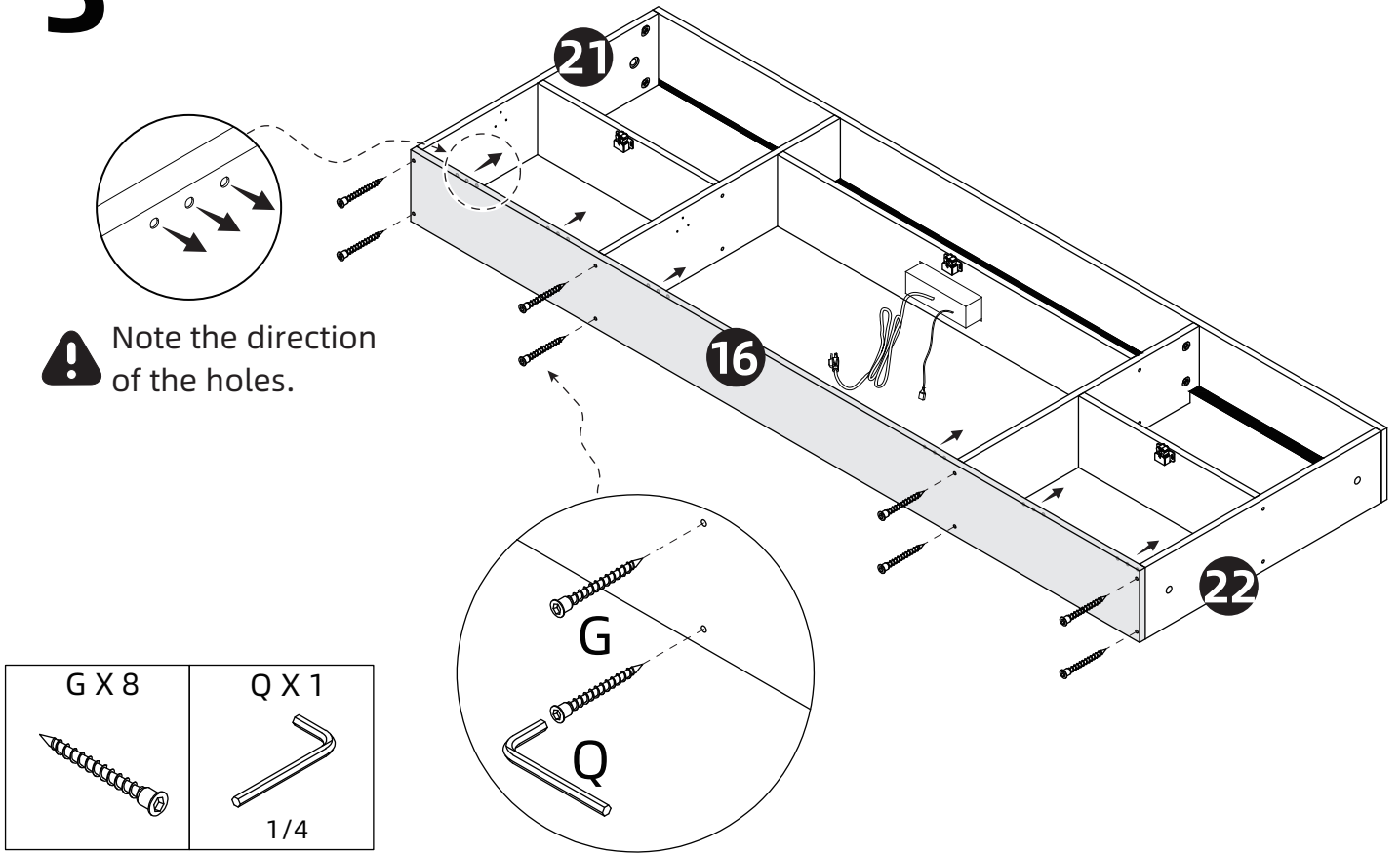

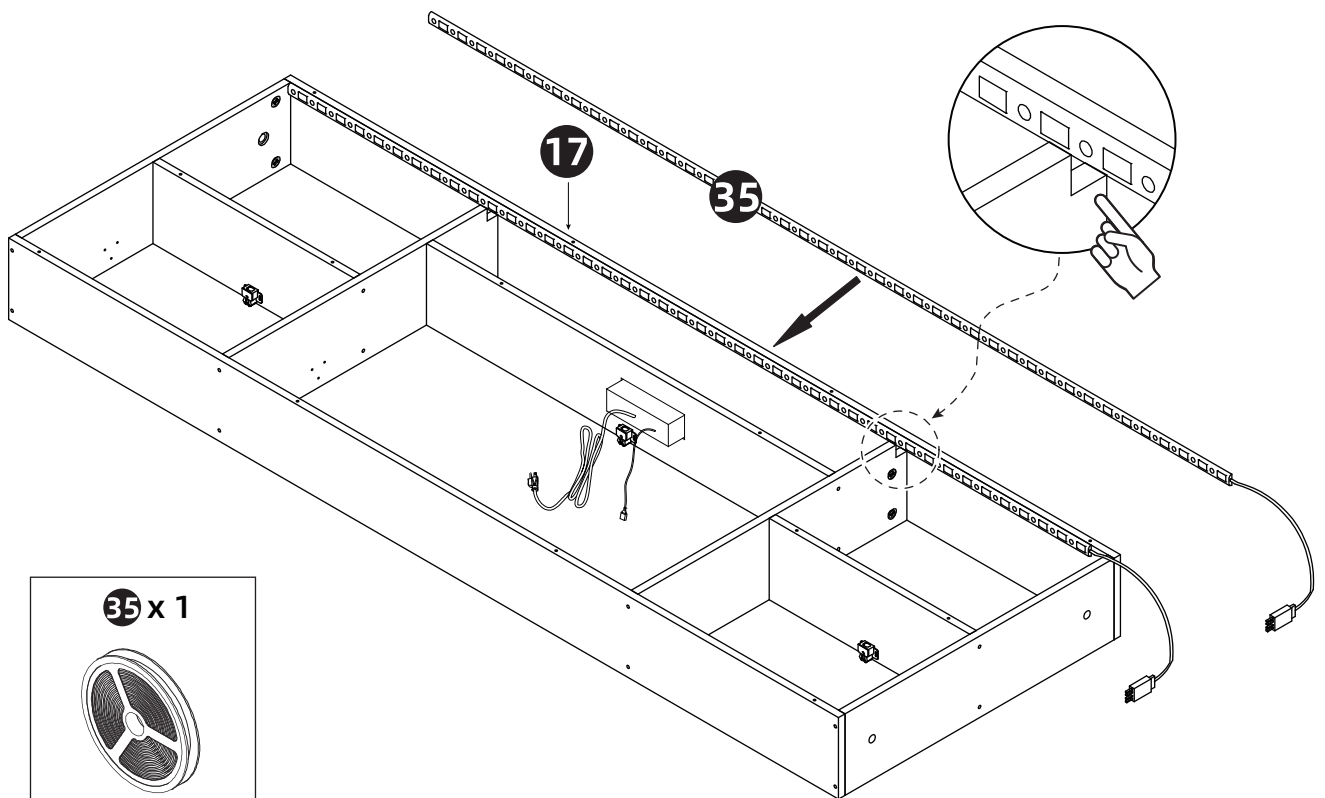

Remove the sticker, then press and paste the LED strip(35)on the proper position.



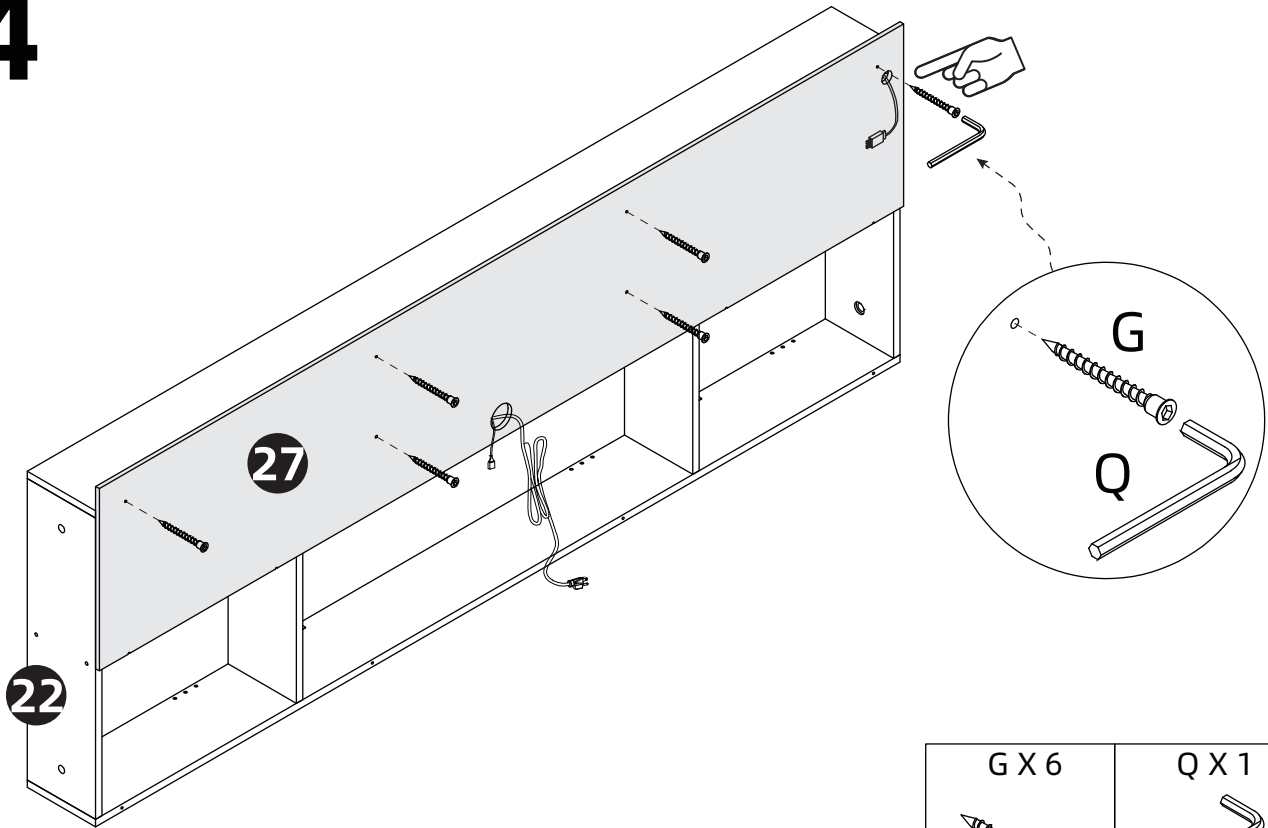

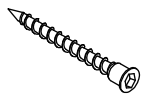
4



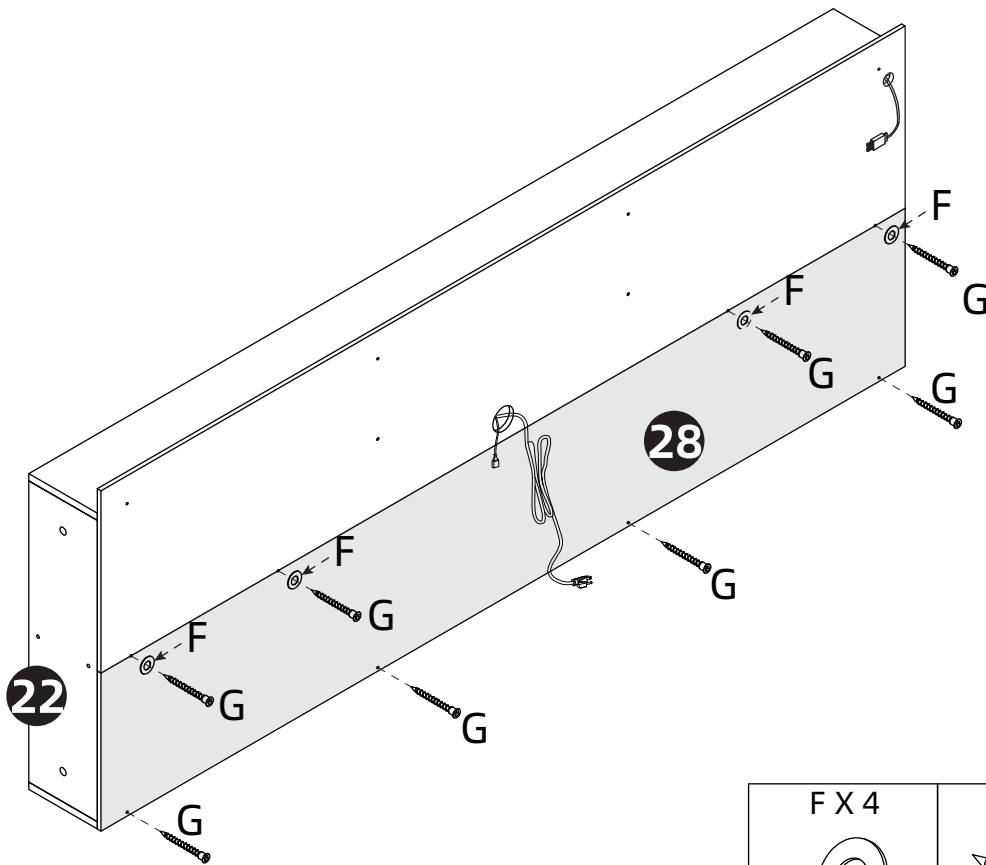

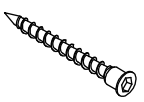
G X 6	Q X 1
	
	1/4

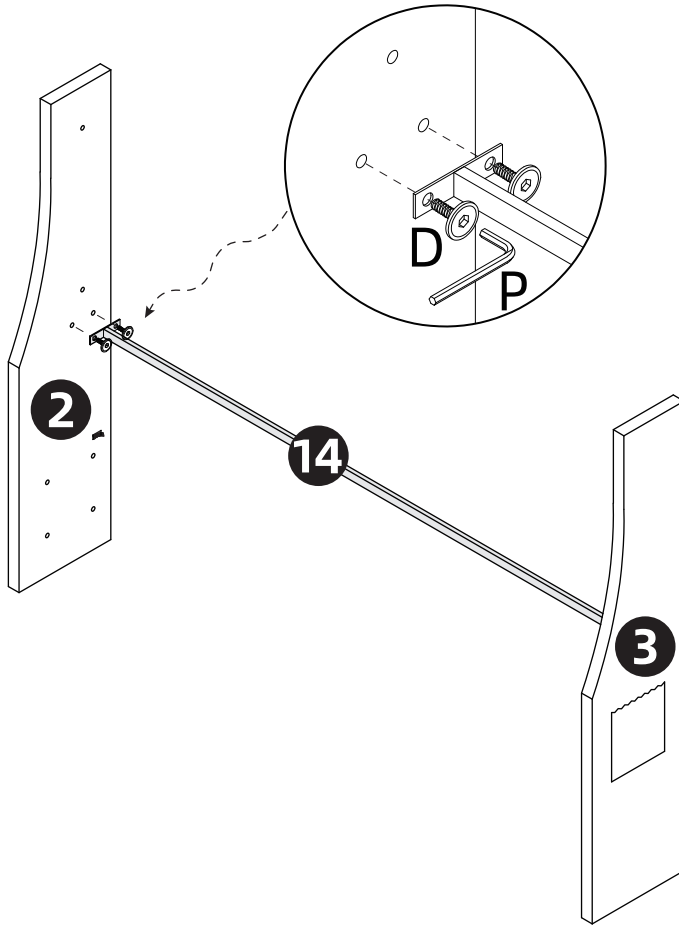

FX 4	G X 8	Q X 1
		
Ø16X1/4		1/4

5



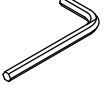

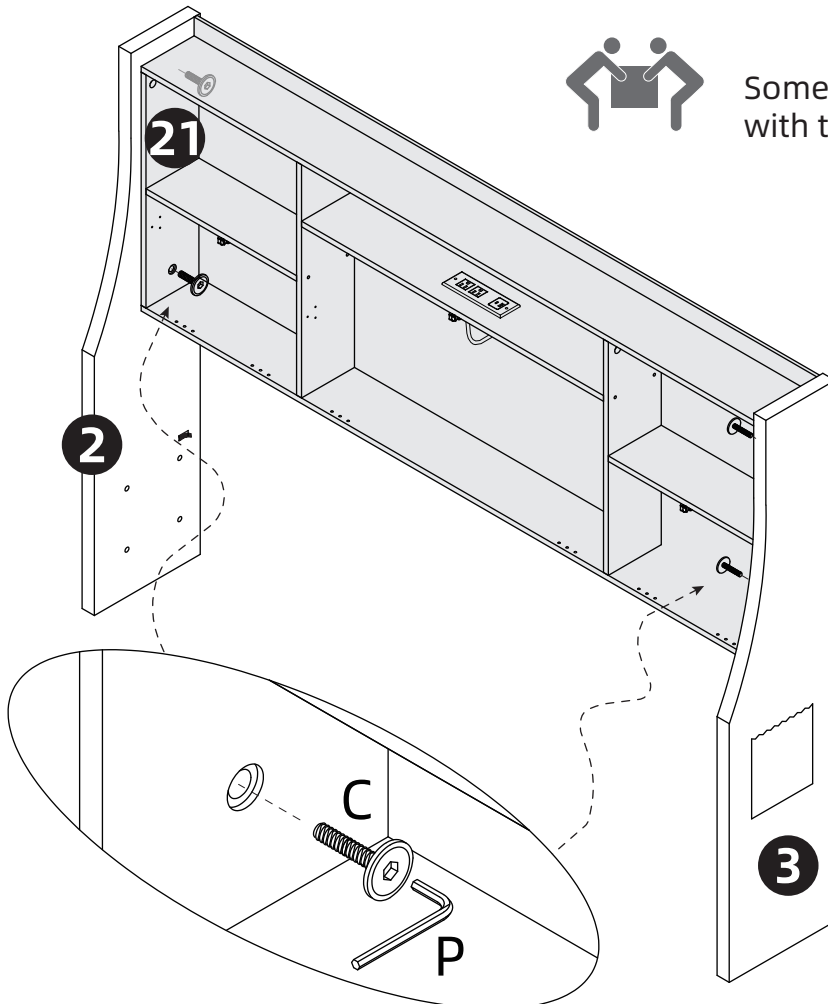
D x 4	PX 1
	
5/16X15mm	5/16



WARNING

Some steps are more easily handled with two adults.

C x 4	PX 1
	
5/16X25mm	5/16

6 ATTENTION

- Do not connect high power household appliances to the socket of this product, which is limited to 1500W.

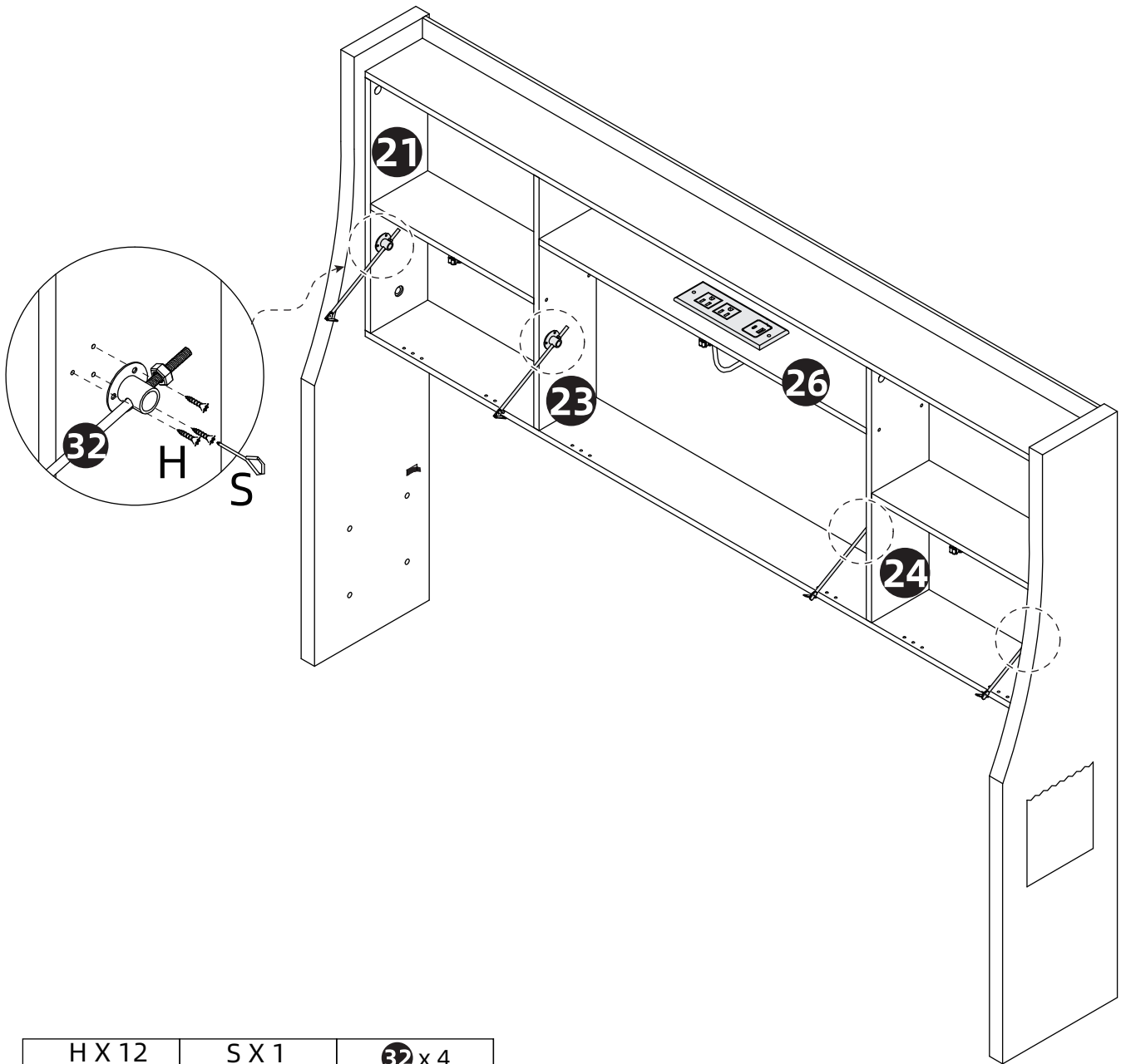

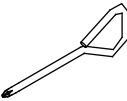
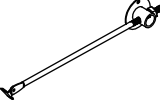
H X 12  M4*12mm	S X 1 	32 x 4 
--	--	--

7

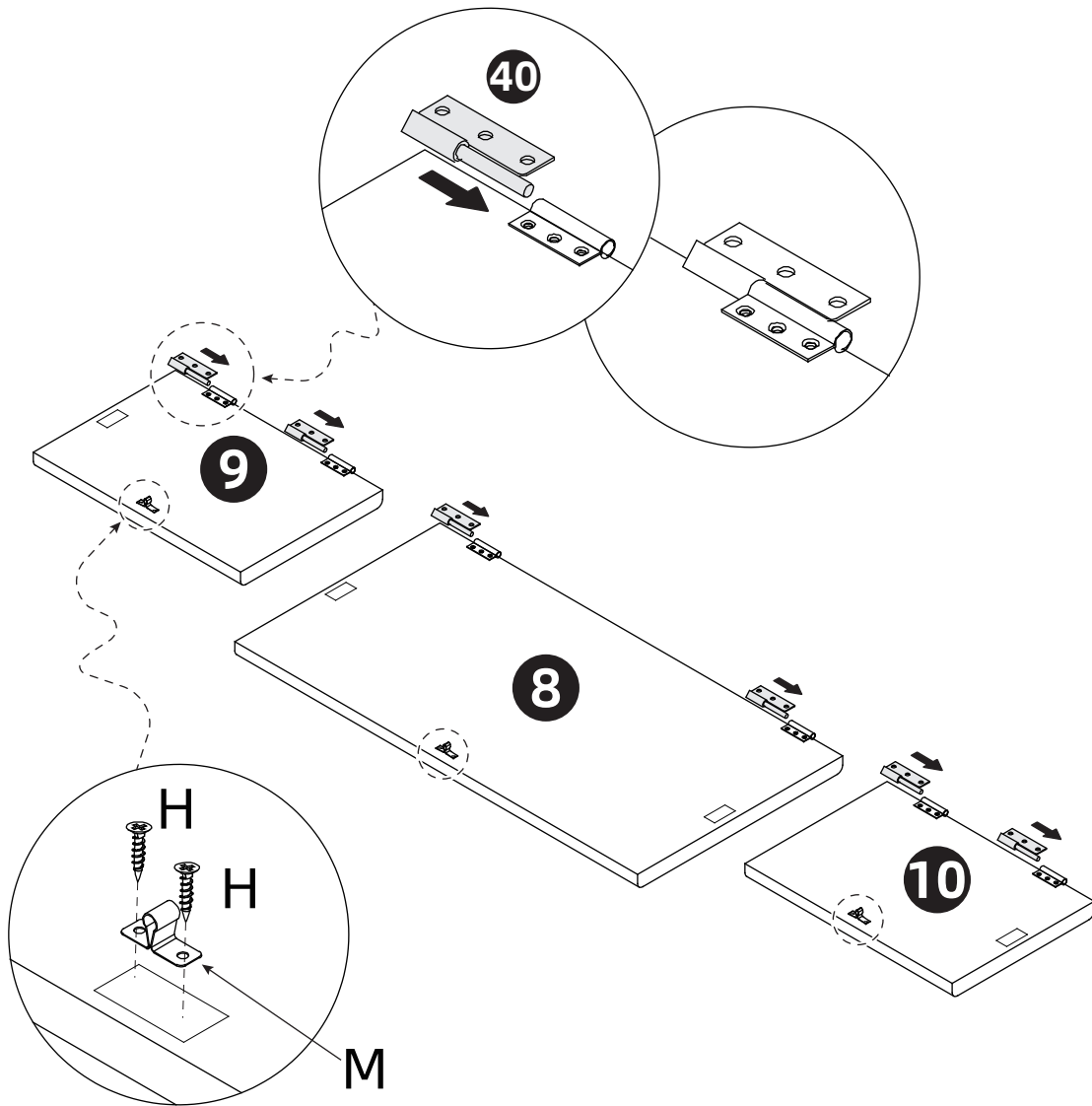

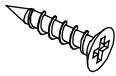
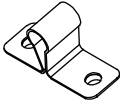
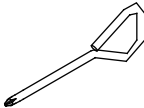
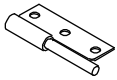
H X 6	M X 3	S X 1	40 x 6
			
M4*12mm			



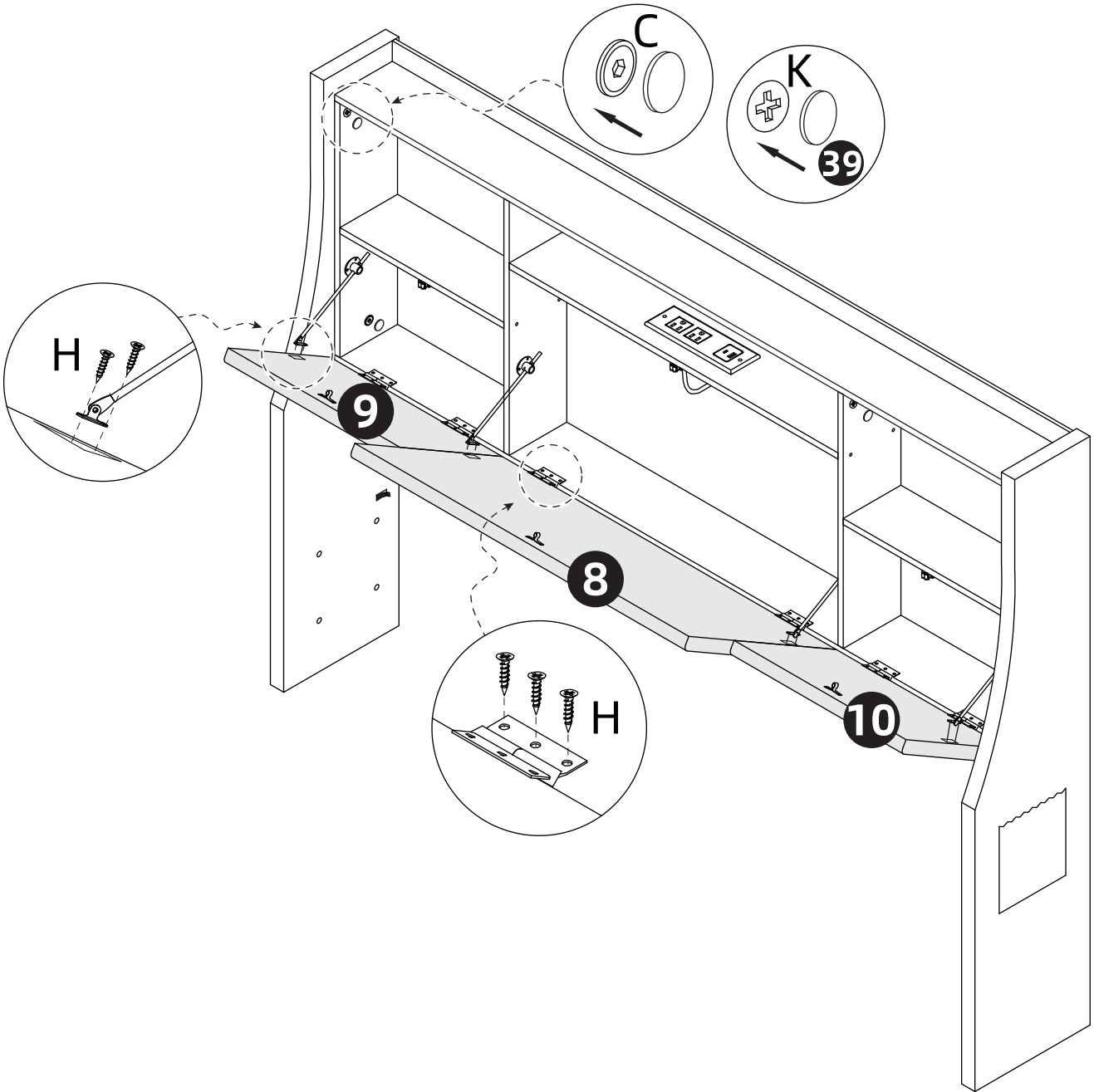

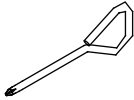
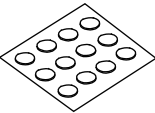
8

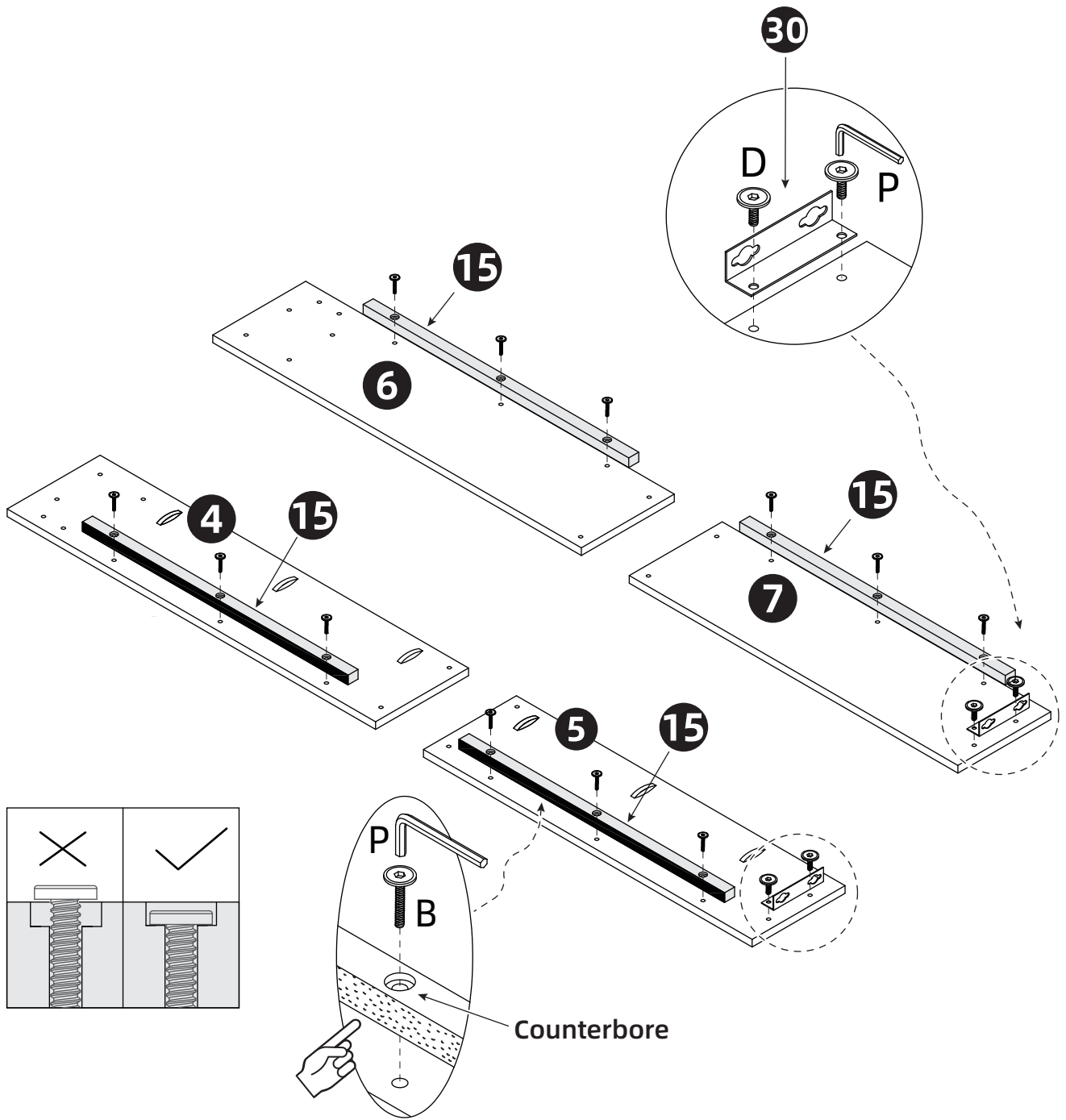

<p>H X 26</p>  <p>M4*12mm</p>	<p>S X 8</p> 	<p>39 x 12</p> 
--	--	--

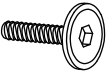

9



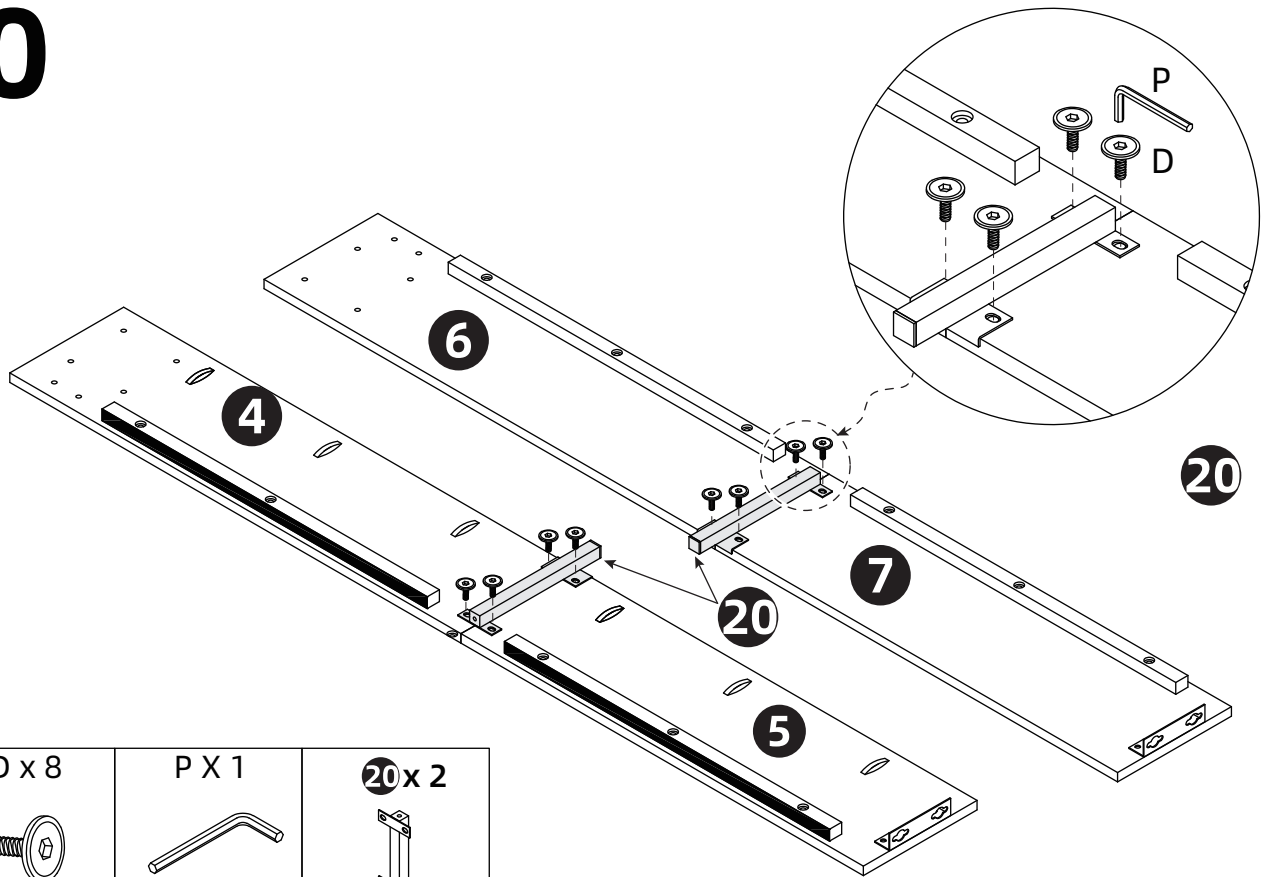

B x 12	D X 4	P X 1	30 x 2
			
5/16X30mm	5/16X15mm	5/16	

10

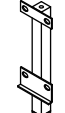

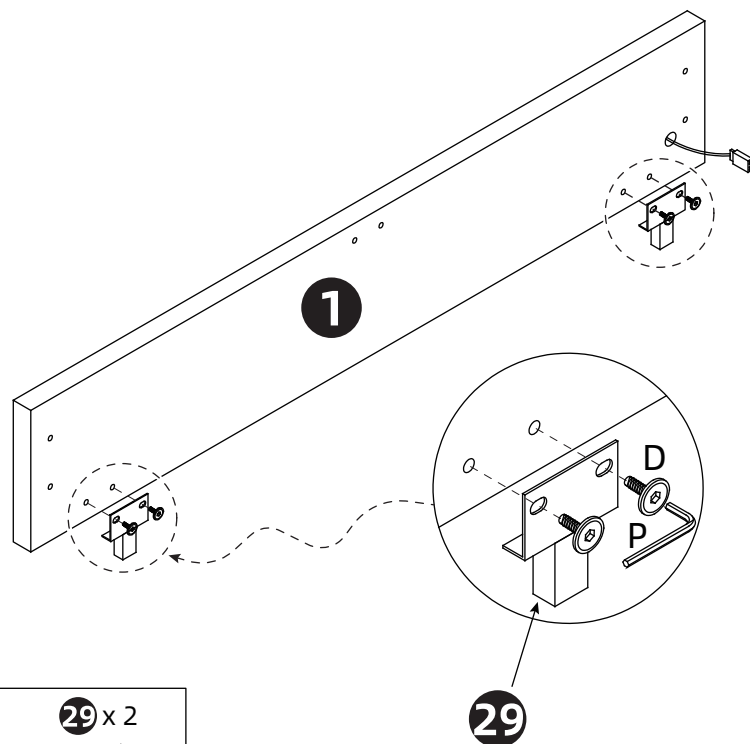
D x 8	P X 1	20 x 2
		
5/16X15mm	5/16	



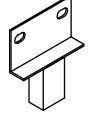

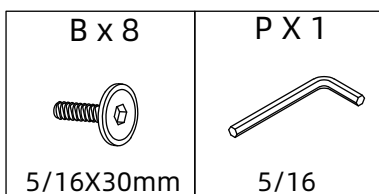
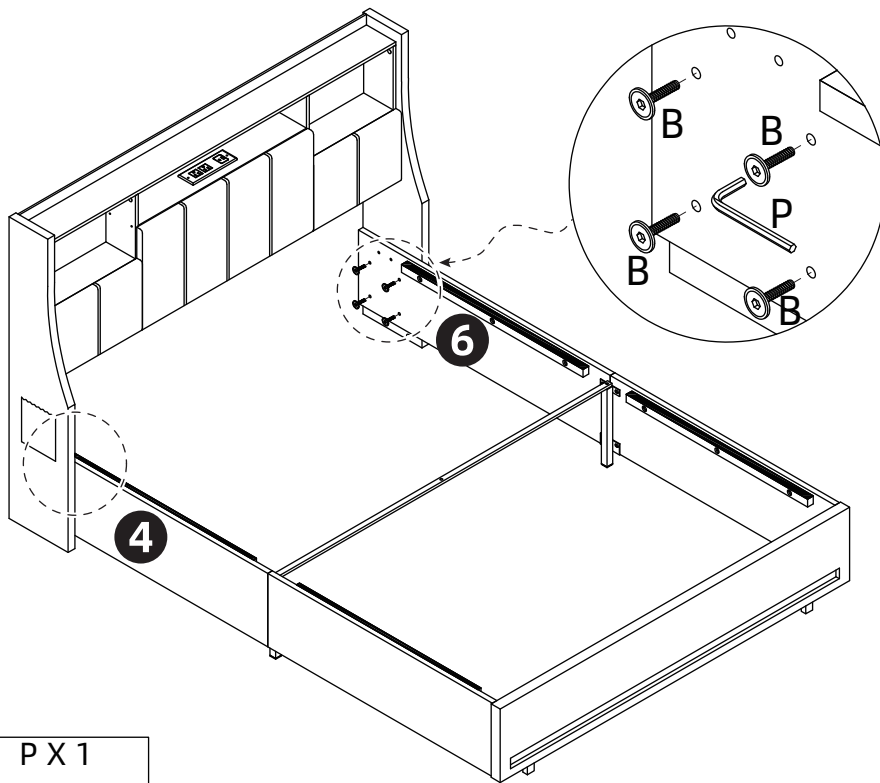
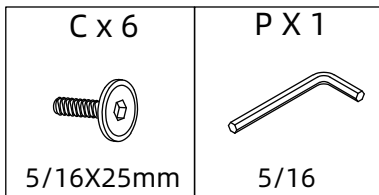
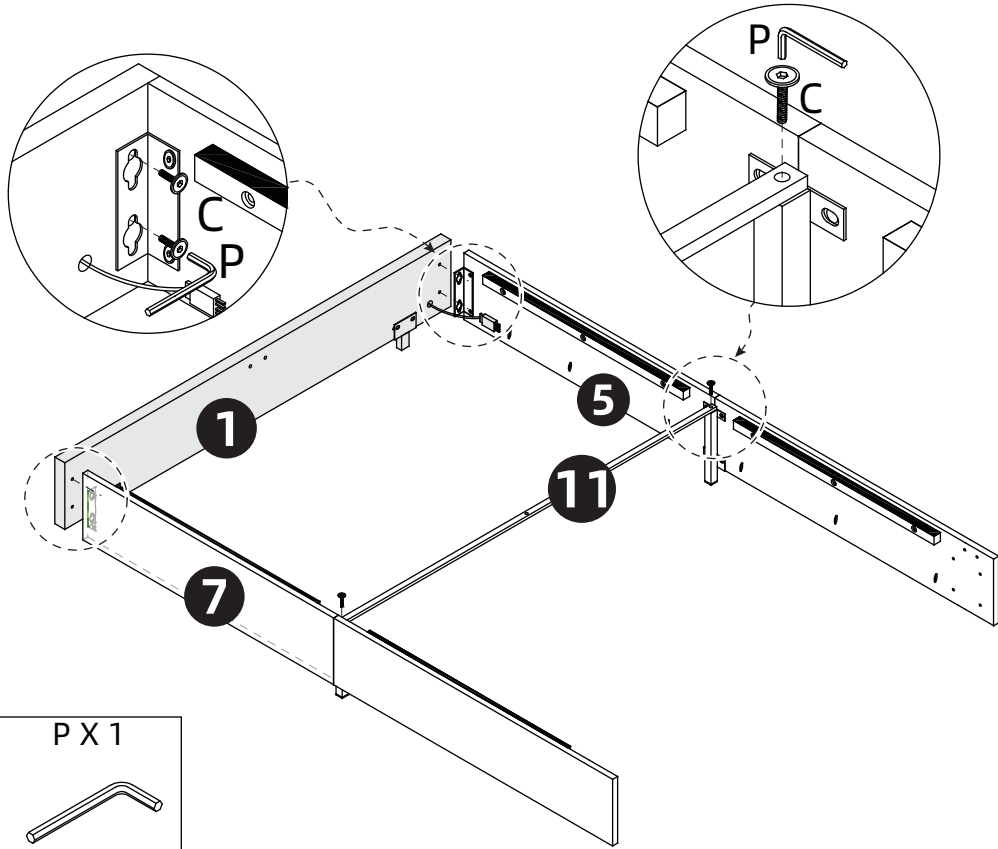

D x 4	P X 1	29 x 2
		
5/16X15mm	5/16	

11

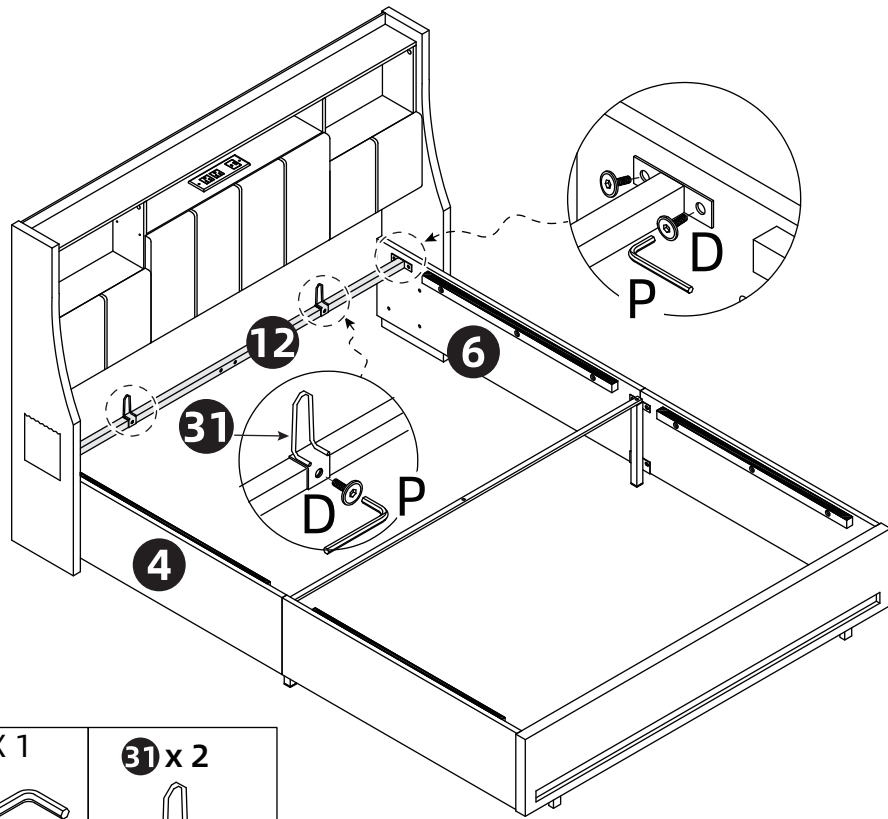



12



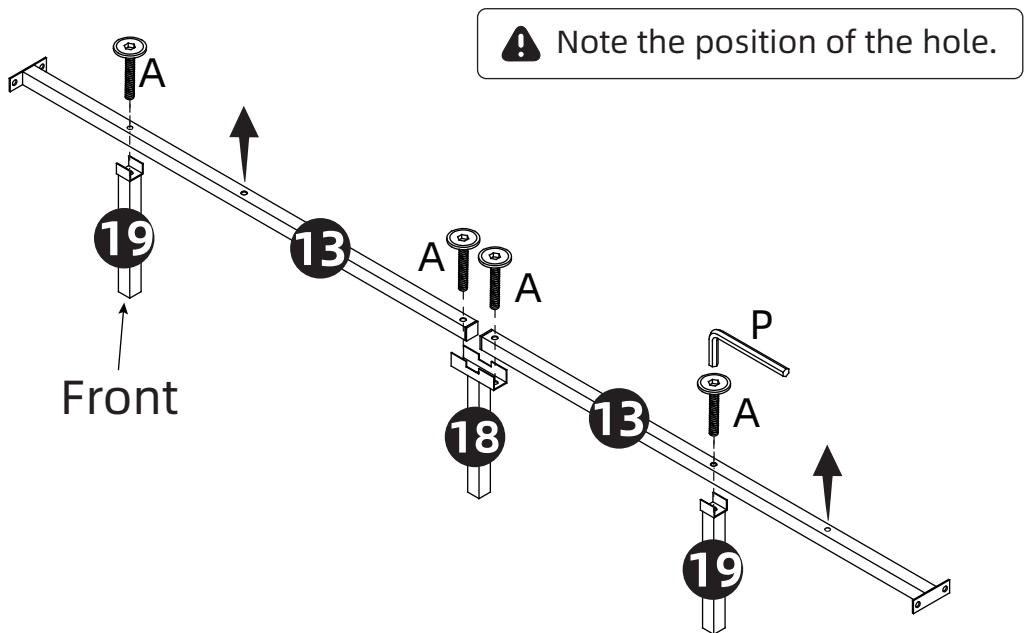

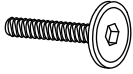

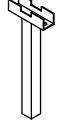
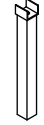

D x 6  5/16X15mm	P X 1  5/16	31 x 2 
---	--	--

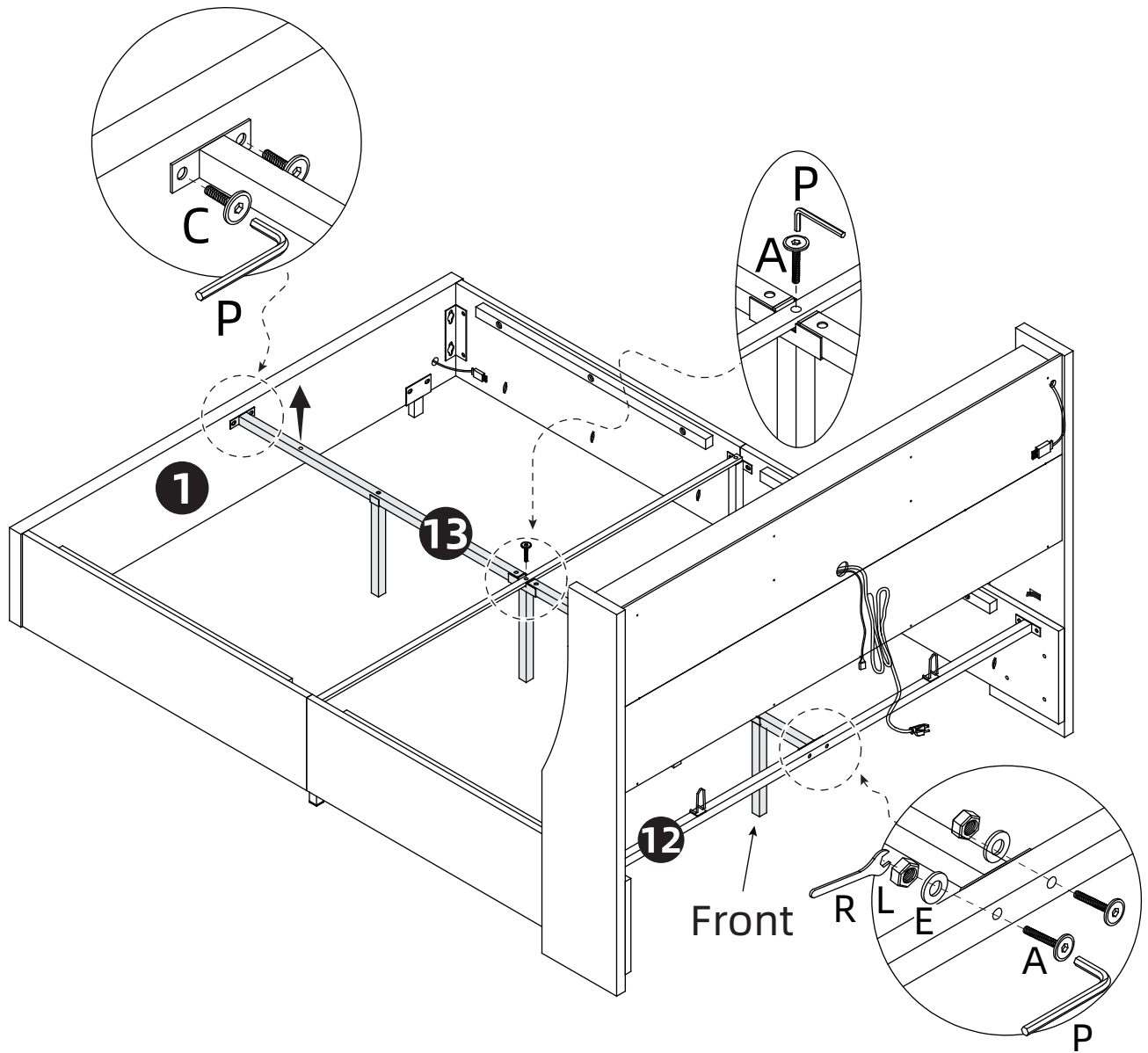

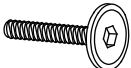
A x 4  5/16X45mm	P X 1  5/16	18 x 1 	19 x 2 
---	--	---	---

13



A x 3	C x 2	E x 2	L x 2	P x 1	R x 1
					
5/16X45mm	5/16X25mm	φ19X5/16	5/16	5/16	5/16

15

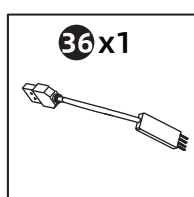
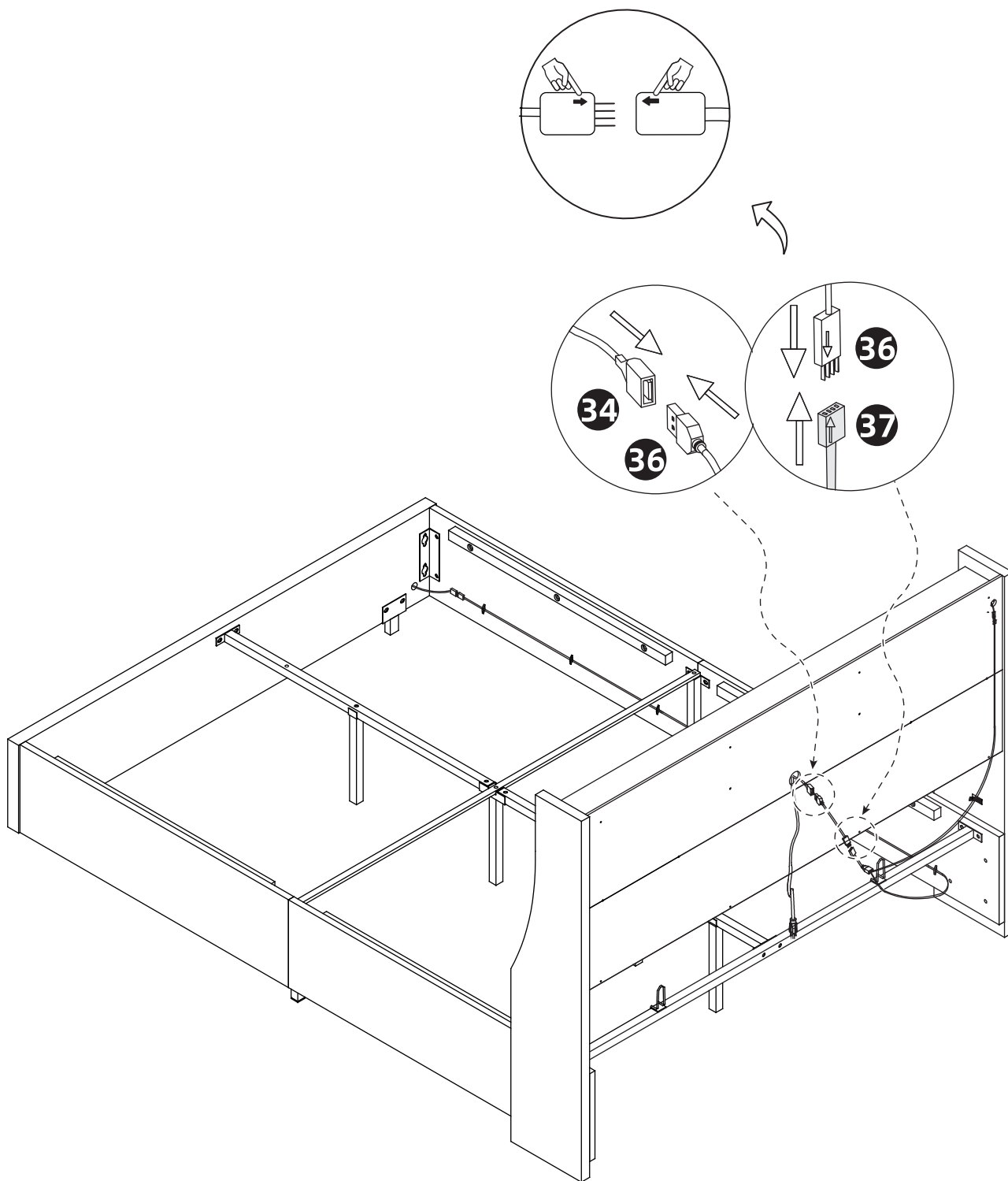

16

