

# ASSEMBLY INSTRUCTIONS

---

## TOOLS REQUIRED



Screwdriver  
( Not included)

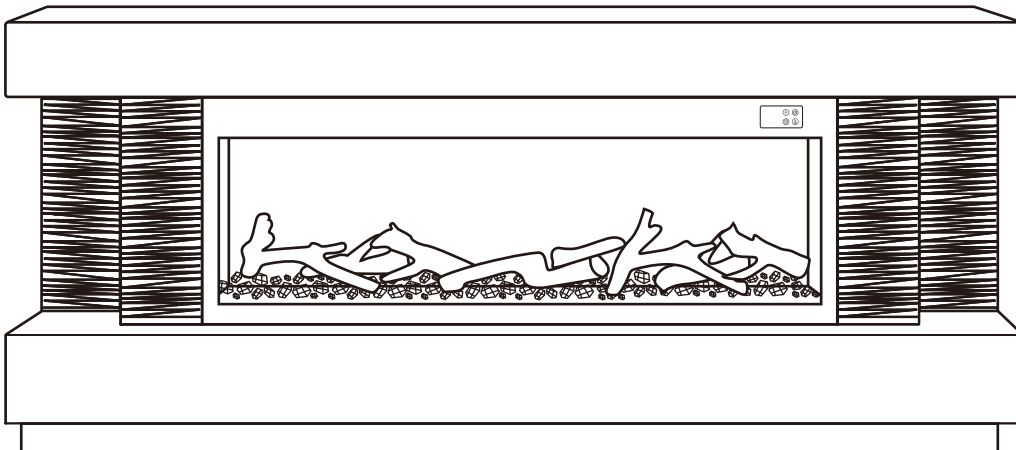

2 - People

## ASSEMBLY RATING



EASY —————> DIFFICULT

The Assembly Rating is a 5-point system showing the level of effort needed to assemble a specific product.



## **CHECK BEFORE STARTING**

### **Are you missing anything?**

Double-check all parts, hardware and accessories listed are all accounted for.

### **Check out our Quick Tips!**

We recommend reviewing the pre-assembly handouts. Even experts need a refresher now and then!

### **Should we send any replacements?**

Are there any irregularities or flaws in the parts? We can send replacements!

### **Prep Time!**

Please review the assembly instructions and all diagrams prior to assembling.

# PRE ASSEMBLY INTRODUCTION

We understand building ready-to-assemble furniture can be a challenging experience for some. To help avoid confusion, we have provided some helpful tips that may speed up the process.



## Teamwork

ALWAYS have at least two people to help with transporting and assembling the product to avoid potential injury and/or damage.



## Suitable Location

Assembling near the area of the intended location is highly recommended.



## Sufficient Space

Make sure you have enough space to move around during the assembly.



## Avoid Scratches

Use cardboard, blankets or a carpeted area while assembling furniture to prevent scratches and damages.



## Flat Surface

Make sure the furniture rests on a flat and level surface with each leg evenly touching the floor.

# ASSEMBLY AND CARE ADVICE



**FAILURE TO FOLLOW THE GUIDELINES BELOW MAY RESULT IN INJURY AND/OR PROPERTY DAMAGE.**



Position each part correctly and insert screws or bolts into their respective holes.

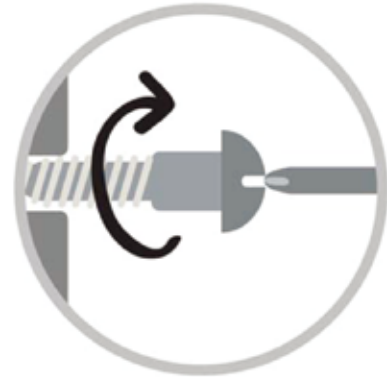

Turn clockwise to tighten and only tighten when step is completed or when instructed to do so.



Use the appropriate hand tools or power tools for assembly. Select steps, such as tightening screws and/or bolts, may require hand tools to avoid causing damage during assembly.



Save the instructions and store any supplied tools for later maintenance.



After two weeks, check and tighten any loose hardware and repeat again every six months thereafter.

**IT IS THE USER'S RESPONSIBILITY TO MAINTAIN THE FURNITURE. THE HARDWARE MAY LOOSEN OVER TIME AND MAY CAUSE THE FURNITURE TO BE WOBBLY AND UNABLE TO SUPPORT ITS INTENDED WEIGHT CAPACITY. THIS MAY LEAD TO COLLAPSE AND MAY CAUSE SERIOUS INJURY.**

# IMPORTANT SAFETY INFORMATION!



## WARNING



- **ALWAYS** keep electric cords, home furnishings, drapes, clothing, papers, or other combustibles at least 3 feet (0.9m) away from the front of this heater, and away from the bottom, sides, and rear of this heater.
- **DO NOT** place the heater near a bed because objects such as pillows or blankets can fall off the bed and be ignited by the heater.
- **DO NOT COVER** this heater or block the air vents at all. Doing so could cause a fire.
- **AVOID** fire or electric shock! **NEVER** insert or allow any foreign objects to enter the ventilation or exhaust openings of this heater.
- **Prevent Fire!** Keep all flammable liquids, like gasoline or paint, away from this heater. This heater produces arcing sparks that could ignite flammable liquids.
- **DO NOT** cover this heater in any manner. Doing so could block the air flow and cause the unit to overheat, or could ignite the material covering the heater.
- **NEVER** run the power cord under carpet, rugs, runners, or any other covering. Doing so could cause the cord or materials covering the cord to overheat.
- **AVOID FIRE!** Regularly inspect all air vents to make sure they are free from dust, lint, or other blockage. Unplug the unit and clean with a vacuum **ONLY**. **DO NOT** rinse or get wet.



## WARNING



- **For residential use only! NOT for commercial use! NEVER** use this fireplace for other than its intended purpose.
- Use extreme caution if using this heater near children or invalids.
- **NEVER** leave this heater unattended. **ALWAYS** unplug this heater when not in use.
- This heater is hot when in use. **AVOID INJURY! DO NOT TOUCH** hot surfaces, or attempt to move this heater while it is hot.
- **ALWAYS** turn this heater off before unplugging it from the outlet.
- **AVOID INJURY!** Keep the cord from crossing traffic areas to avoid tripping.
- **NEVER** modify this fireplace. Doing so could result in **personal injury** or property damage. Modification of this fireplace completely voids all warranties.
- Discontinue use if this fireplace malfunctions or is dropped or damaged in any manner.
- **ALWAYS** store this heater in a dry location. **NEVER** use the fireplace if it has become wet.



# WARNING



- Risk of electric shock! DO NOT OPEN! No user-serviceable parts inside!
- ALWAYS disconnect this unit from the power supply before performing any assembly or cleaning, before replacing the light bulb, or before relocating the electric fireplace.
- NEVER use this heater in bathrooms, laundry rooms, or any other location where the heater could fall into a bathtub or pool, become damp or come in contact with water.
- NEVER hang this unit on a wall directly below an electrical outlet.
- NEVER operate this heater if the power cord or plug has become damaged, or if the grounding pin is damaged or missing.
- Place the heater near a wall outlet so an extension cord is not needed. If an extension cord is needed, the gauge of the cord must be at least 14AWG, and the rating must be at least 1875 Watts. NEVER use a smaller gauge cord with a lower rating. Doing so may result in fire or electric shock.
- Avoid hazards due to resetting of the thermal cut-off switch. NEVER control this unit with a timer, or allow it to be on a circuit regularly switched off by the utility.
- ONLY use this heater on a 110-120 Volt 15 Amp grounded circuit. NEVER overload the circuit. If this heater trips the circuit breaker, unplug all other appliances on the same circuit before the next use. Avoid plugging other appliances into the same circuit as this heater.
- NEVER plug this heater into an outlet that is old, cracked, or has any loose wires or connections. Plugging this heater into a faulty outlet could result in electric arcing within the outlet that could cause the outlet to overheat or catch fire.
- ALWAYS check your heater cord and plug connections with each use!
  - i) MAKE SURE the plug fits tight in the outlet! Faulty wall outlet connections or loose plugs can cause the outlet to overheat.
  - ii) Heaters draw more current than small appliances. Overheating may occur even if it has not occurred with the use of other appliances.
  - iii) During use check frequently to see if the plug outlet or faceplate is HOT!
  - iv) If the outlet or faceplate is HOT, discontinue use immediately and have a qualified electrician inspect and/or replace the faulty outlets.

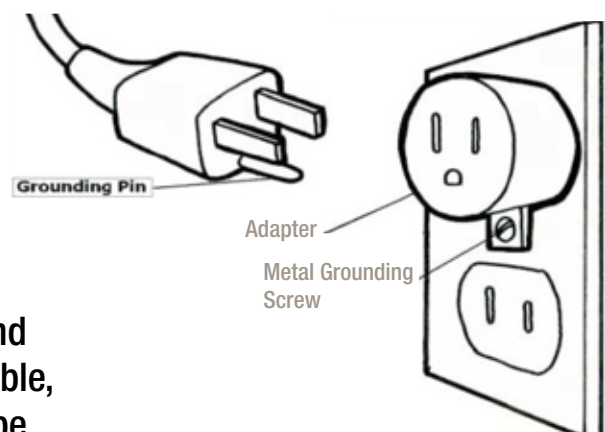

- The cord supplied with the heater has a plug with two blades (live and neutral) and one round pin (ground). If a 3-slot receptacle is not available, an adapter MUST be used. The adapter MUST be properly grounded to the outlet box (see figure at right).

# IMPORTANT INSTRUCTIONS

## SAVE THESE INSTRUCTIONS!

WHEN USING ELECTRICAL APPLIANCES, BASIC PRECAUTIONS SHOULD ALWAYS BE FOLLOWED TO REDUCE THE **RISK OF FIRE, ELECTRIC SHOCK, AND INJURY TO PERSONS**, INCLUDING THE FOLLOWING:

1. Read all instructions before installing or using this heater.
2. This heater is hot when in use. To avoid burns, do not let bare skin touch hot surfaces. Keep combustible materials, such as furniture, pillows, bedding, papers, clothes, etc. and curtains at least 3 feet (0.9m) from the front of the heater and keep them away from the sides and rear (sides and rear restrictions apply to location dedicated heaters only).
3. Extreme caution is necessary when any heater is used by or near children or invalids and whenever the heater is left operating and unattended.
4. Do not operate any heater after it malfunctions. Disconnect power at service panel and have heater inspected by a reputable electrician before reusing.
5. Do not use outdoors. (Omitted if the heater is intended for outdoor use.)
6. To disconnect heater, turn controls to off, and turn off power to heater circuit at main disconnect panel (or operate internal disconnect switch if provided).
7. Do not insert or allow foreign objects to enter any ventilation or exhaust opening as this may cause an **electric shock** or fire, do not block air intakes or exhaust in any manner.
8. To prevent a possible fire, do not block air intakes or exhaust in any manner.
9. A heater has hot and arcing or sparking parts inside, Do not use it areas where gasoline, paint, or flammable vapors or liquids are used or stored.
10. Use this heater only as described in this manual. Any other use not recommended by the manufacturer may cause fire, **electric shock**, or **injury to persons**.
11. This heater may include an audible or visual alarm to warn that parts of the heater are getting excessively hot. If the alarm sounds (or illuminates), immediately turn the heater off and inspect for any objects on or adjacent to the heater that may have blocked the airflow or otherwise caused high temperatures to have occurred. **DO NOT OPERATE THE HEATER WITH THE ALARM SOUNDING (OR ILLUMINATING).**

12. **“SAVE THESE INSTRUCTIONS”**

# SAFETY INFORMATION

## SAVE THESE INSTRUCTIONS!



**WARNING:** There are no user serviceable parts inside the fireplace/heater. If the unit appears to malfunction, turn the unit off and unplug the unit from the wall immediately.



**WARNING:** Always unplug the heater when not in use.



**WARNING:** This heater is hot when in use. To avoid burns, do not let bare skin touch hot surfaces. If provided, use handles when moving this heater. Keep combustible material, such as furniture, pillows, bedding, papers, clothes and curtains at least 3 ft. (0.9 meters) from the front of the heater and keep them away from the sides and rear.



**WARNING:** Do not insert or allow foreign objects to enter any ventilation or exhaust openings as this may cause an **electric shock** or fire, or damage the heater.



**WARNING:** A heater has hot and arching or sparking parts inside. Do not use in areas where gasoline, paint, or flammable liquids are used or stored.



**WARNING:** Extreme caution is necessary when any heater is used by or near children or invalids and whenever the heater is left operating and unattended.



**CAUTION:** While the heater is in use, the top center of the fireplace can get hot to the touch, and may cause serious **injury** or burns. Always supervise small children around the fireplace/heater. Do not place any cloth or decorations over the heater outlet of the fireplace, or otherwise obstruct the heater outlet of the fireplace, as this may cause a fire and serious **injury** may result.



**WARNING:** Do not operate any heater with a damaged cord or plug or after the heater malfunctions, has been dropped or damaged in any manner. Return the heater to an authorized service facility for examination, electrical or mechanical adjustment, or repair.

## GROUNDING INSTRUCTIONS



**CAUTION:** While the heater is in use, the top center of the fireplace can get hot to the touch, and may cause serious **injury** or burns. Always supervise small children around the fireplace/heater. Do not place any cloth or decorations over the heater outlet of the fireplace, or otherwise obstruct the heater outlet of the fireplace, as this may cause a fire and serious **injury** may result.

This product must be grounded. If it should malfunction or breakdown, grounding provides a path of least resistance for electric current to reduce the risk of **electric shock**. This product is equipped with a cord having an equipment-grounding conductor and a grounding plug. The plug must be plugged into an appropriate outlet that is properly installed and grounded in accordance with all local codes and ordinances.

This heater is for use on 120 volt circuits and has a grounded plug. An adapter is available for connecting three-blade grounding type plugs to two-slot receptacles. The green grounding lug extending from the adapter must be connected to a permanent ground such as a properly grounded outlet box. The adapter should not be used if a three-slot grounded receptacle is available.

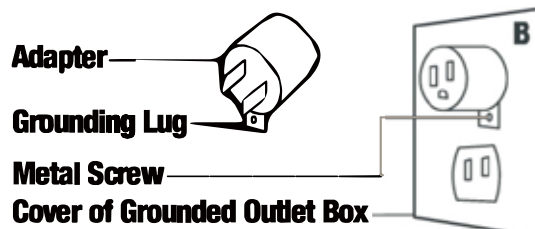
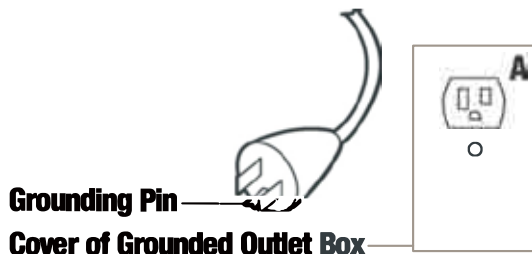

# SAFETY INFORMATION (CONTINUED)

## FCC STATEMENT

**Note:** This equipment has been tested and found to comply with the limits for a Class B digital device, pursuant to Part 15 of the FCC Rules.

These limits are designed to provide reasonable protection against harmful interference in a residential installation. This equipment generates, uses, and can radiate radio frequency energy and, if not installed and used in accordance with the instructions, may cause harmful interference to radio communications. However, there is no guarantee that interference will not occur in a particular installation. If this equipment does cause harmful interference to radio or television reception, which can be determined by turning the equipment off and on, the user is encouraged to try to correct the interference by one or more of the following measures:

- Reorient or relocate the receiving antenna.
- Increase the separation between the equipment and the receiver.
- Connect the equipment into an outlet on a circuit different from that to which the receiver is connected.
- Consult the dealer or an experienced radio/TV technician for help.

This device complies with Part 15 of the FCC Rules. Operation is subject to the following two conditions:

1) This device may not cause harmful interference, and

2) This device must accept any interference received, including interference that may cause undesired operation.

**CAUTION:** Changes or modifications not expressly approved by the party responsible for compliance could void user's authority to operate the equipment.

# TV STAND

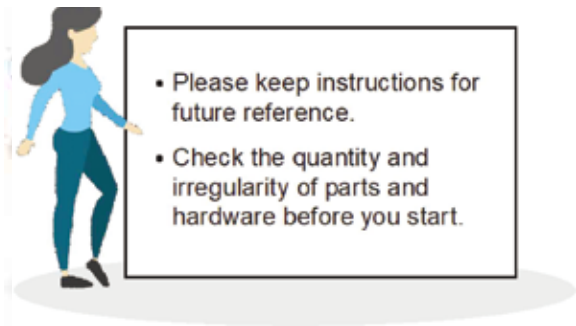

## PARTS IDENTIFICATION

A TV STAND

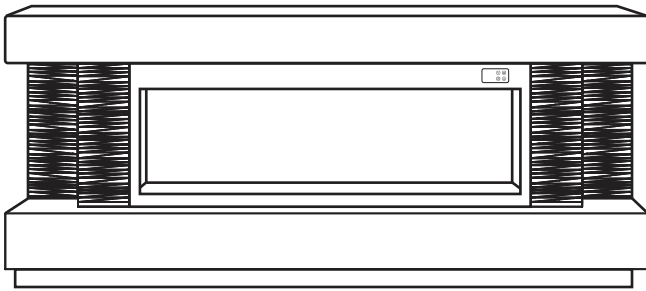

1PC

B FAUX CRYSTAL

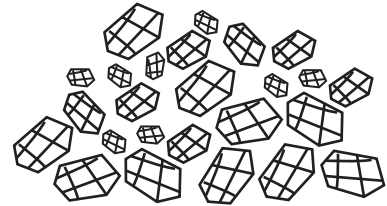

1BAG

C REMOTE CONTROL



1PC

D RGB LED CONTROL

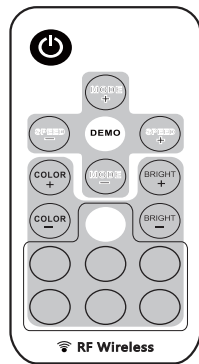

1PC

E DOWN LIGHT CONTROL

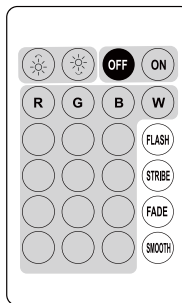

1PC

F CHARCOAL

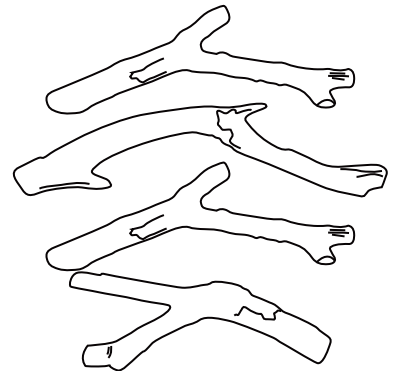

1BAG

# ASSEMBLY INSTRUCTIONS

# 1

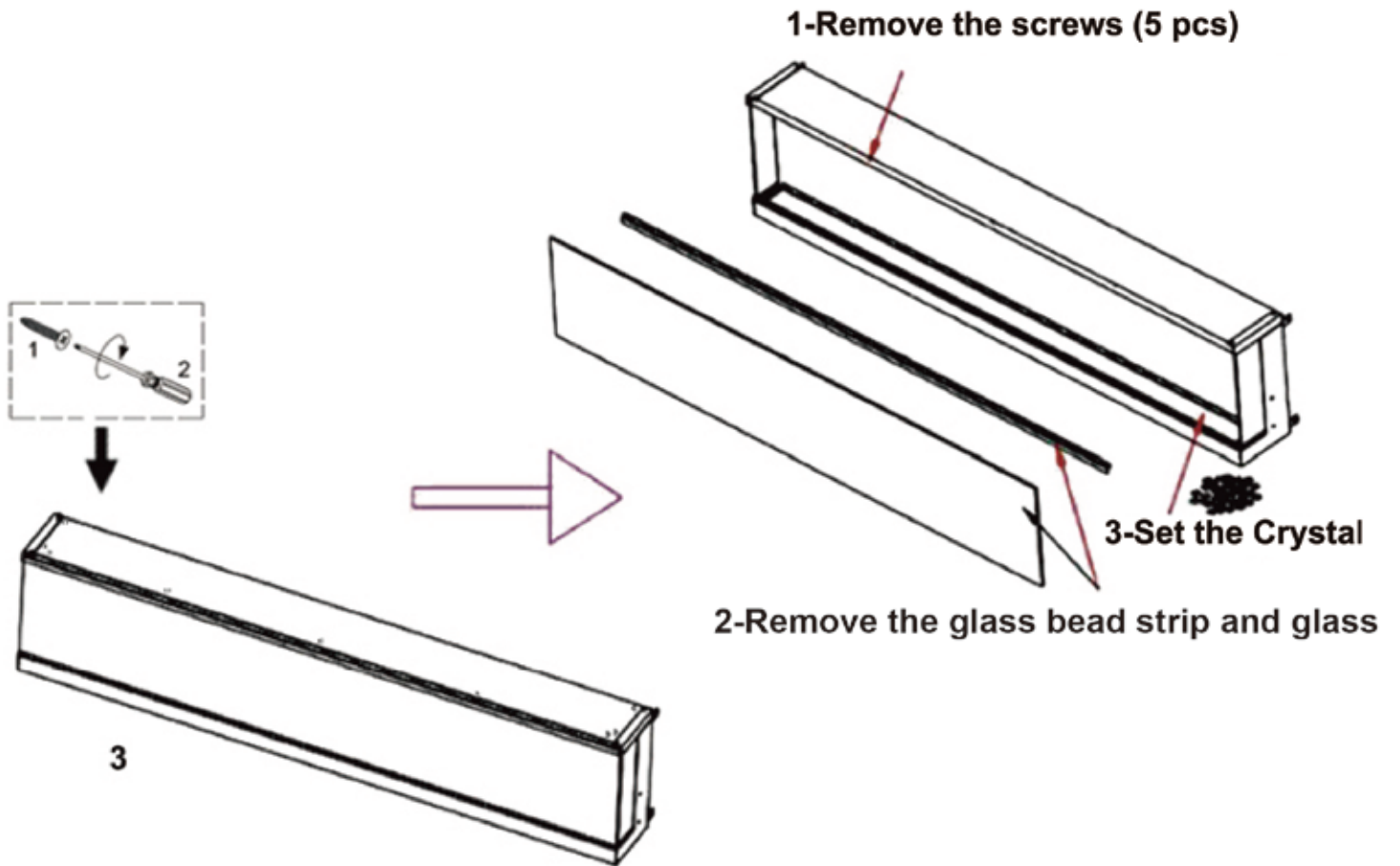

**Open the 3D flame simulator insert box and evenly distribute the crystals**

# ASSEMBLY INSTRUCTIONS

## 2

Finish:

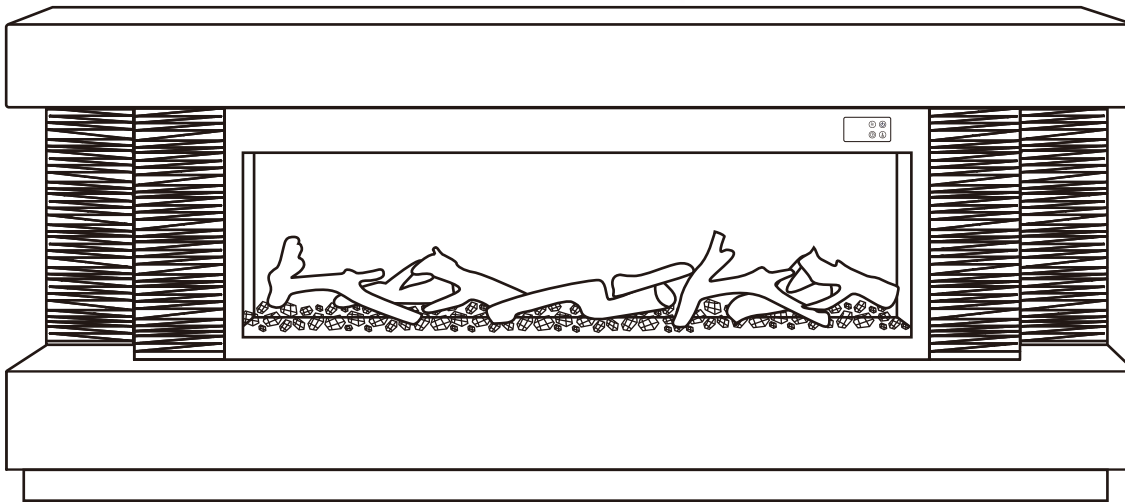
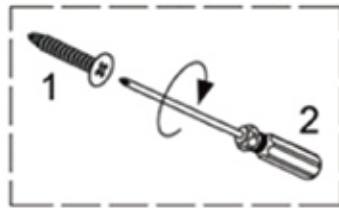

NOTE: SCREW DRIVER IS NOT INCLUDED

**ASSEMBLY COMPLETED**

Please ensure the furniture rests on an even and flat surface. If the product wobbles or feels loose, double-check all bolts and/or screws are properly tightened and secured.

- ✓ **Keep this handy!**  
Please retain this instruction manual and any order-related information for future reference.
- ✓ **Lift, don't drag!**  
To avoid damage to product please always LIFT the product when transporting or adjusting the placement.

This product is intended for RESIDENTIAL USE ONLY and not for commercial use.

# ANTI-TIPPING INSTALLMENT INSTRUCTIONS

## FURNITURE TIPPING RESTRAINT

### WARNING

Injury may result from tipping furniture.

This restraint may protect against tipping furniture.

Do not allow children to climb on furniture.

This restraint is not a substitute for proper adult supervision.

Failure to detach this restraint before moving the furniture may result in injury and damage.

This tip restraint must be attached to a wall stud using long screw enclosed.

### STEP 1

Attach a bracket securely to the back top rail of the furniture using short screw provided, through the smaller hole.

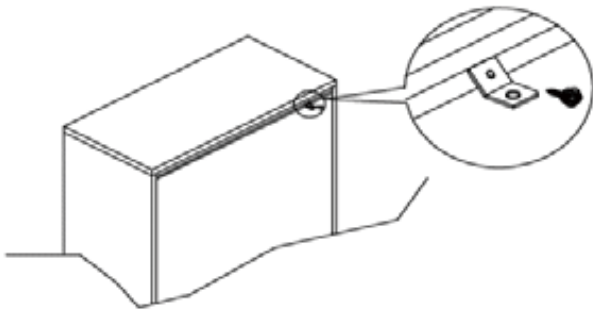

### STEP 2

Locate the other bracket on the wall over stud and two inches below the mounting bracket secured to the back of the furniture. Attach the wall stud using the long screw provided, through the smaller hole.

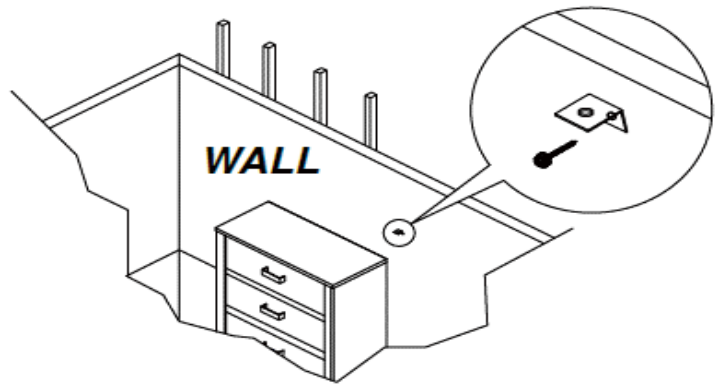

### STEP 3

Place the furniture into position so both mounting brackets are vertically in line. Lace the end of the restraint strap through the larger hole in each mounting bracket. Bring both ends together and slide the flat end through the locking end and draw it through until all slack is removed. Confirm that the strap is securely laced and locked.

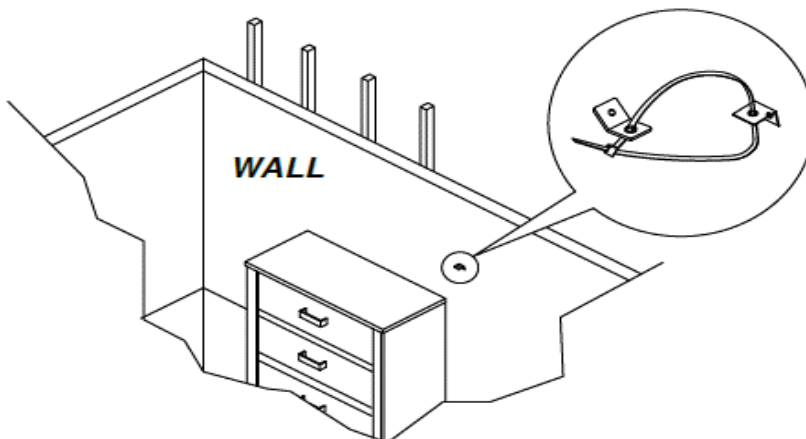

# USER INSTRUCTIONS

## Bluetooth Speaker Instruction

### CONTROL PANEL MENU:

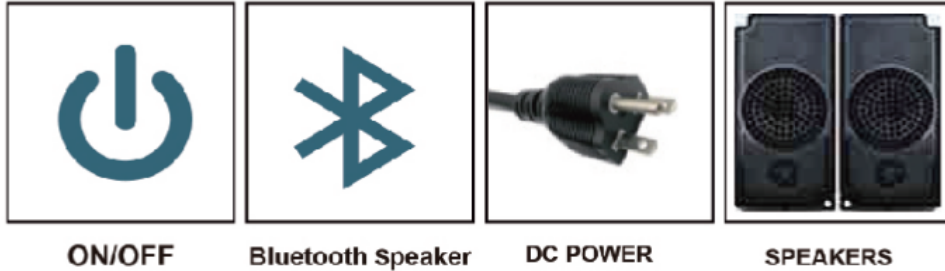

### INSTRUCTION STEPS AS FOLLOWED:





- 1 Connect the DC power adapter to wall socket
- 2 Turn the switch ON
- 3 Enable the bluetooth function in your digital device
- 4 Search for bluetooth speaker name "RS01"
- 5 Pair with the bluetooth speaker name "RS01"
- 6 Start playing your audio

To use the Auxiliary function, switch from Off to On.  
Connect the Auxiliary Audio cable to the input on your furniture.  
Once the connections are secure, start playing.

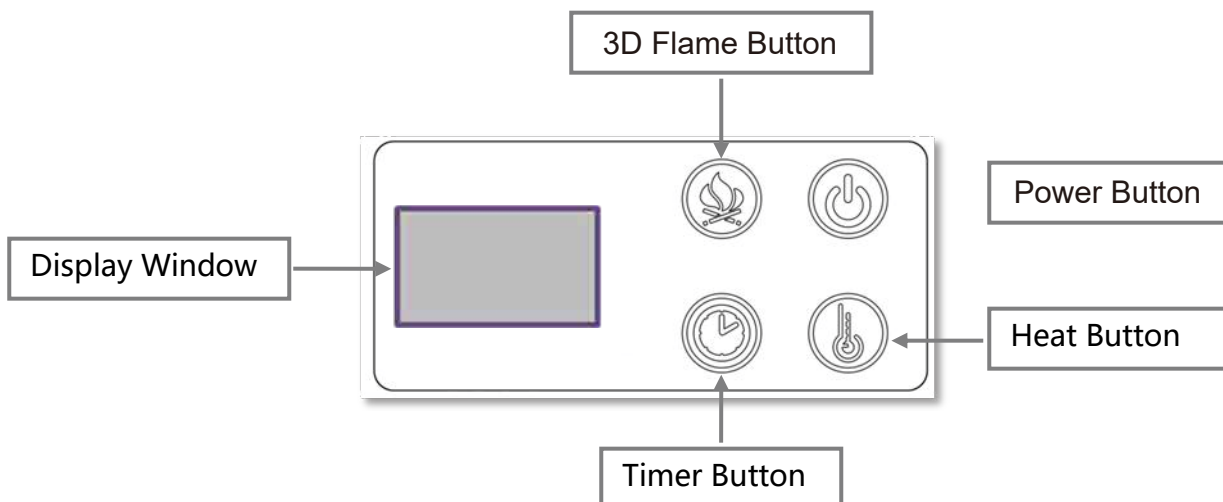
### Flame Simulator Keypad Function Instructions:

### \*Keyboard operation of electric fireplace.



| BUTTON   | Operation  | Function   |
|--|--|--|
|  <b>Power</b>                    | When the Power is turned on, the display shows the ambient temperature and the flame is turned on.   |  |
|  <b>Flame</b>                    | 1)Short press the flame button to turn on the flame color change;<br>2)Long press to open the child lock, and all key plates cannot be operated; Long press the child lock to unlock, and press the key plate to use normally. | 1)There are L1-L12 color changes, and L13 is the first 12 colors of the loop   |
| <br><br><b>Heater</b>           | Press and hold for 3 seconds to turn heating on and off; Every time the heating function is turned on, the heating will be forced to heat for 20 seconds (testing and demonstration of heating function).                      | <ul style="list-style-type: none"> <li>● Press the heating key briefly to set the temperature, and do not operate for 15 seconds to lock the current temperature setting value;</li> <li>● The ambient temperature will be displayed after 15 seconds without any operation, and the digital tube information screen will be displayed after 5 seconds (27°C/80 °F by default when heating is turned on);</li> <li>● When NTC senses that the ambient temperature is <math>\geq</math> the set temperature+2, the heater stops working (the fan is turned off with a delay of 3 seconds);</li> <li>● When NTC senses that the ambient temperature is lower than the set temperature, the heater will work again;</li> <li>● When the heating is turned off, the fan is delayed for 3 seconds;</li> <li>● The ambient temperature will be displayed after 15 seconds without any operation, and the digital tube information screen will be displayed after 5 seconds;</li> <li>● The default starting time is Fahrenheit (90°F/85 °F/80°F/75°F/70°F/65°F/60°F), and it can be converted into Celsius (32°C/29°C/27°C/24°C/21°C /18°C/16°C) by pressing for 5 seconds.</li> </ul> |
| <br><br><b>Timer</b>           | Long press the timer to turn on or off the timer function, the default is 0.5H (timer can reach 8H).   | Press timer to select time 0.5H, 1H, 2H, 3H, 4H, 5H, 6H, 7H, 8H;<br>After 15 seconds of no operation, the setting will be automatically locked, the timer will be displayed, and the screen will be off after 5 seconds;<br>When the timer ends, it will automatically shut down   |
| <br><br><b>Display Window</b> | Display the numbers flame, carbon bed, heating and timing  |  |

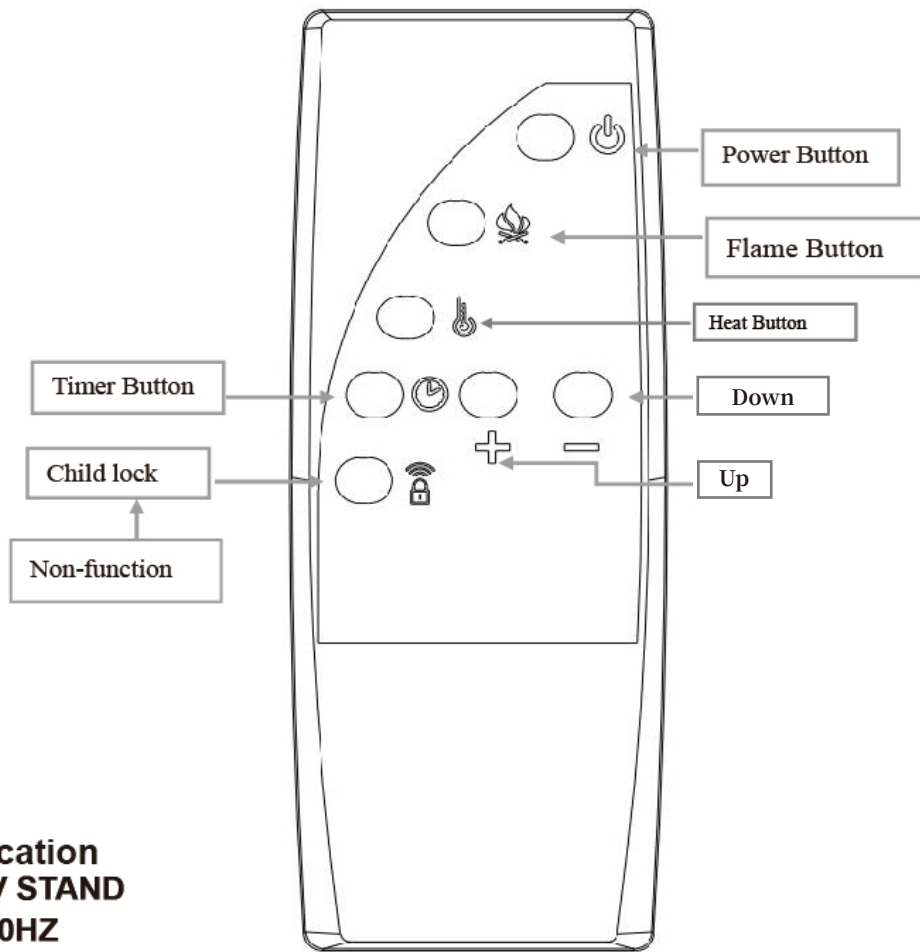

**Technical Specification**  
**Product name : TV STAND**

**Supply: 120V AC 60HZ**

**Rared power: 50W**

**Bluetooth: The phone connects to RS01 to play music**

**Press to turn on/off the lights.**

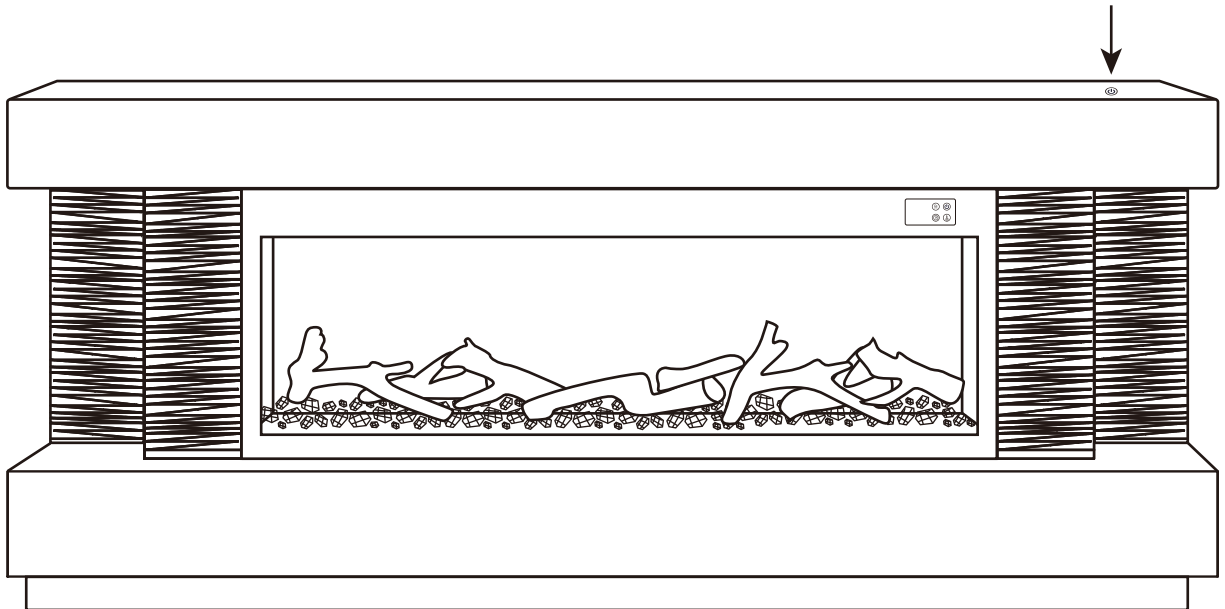

**Note Dimension tolerance  $\pm 5\%$**

# MAINTENANCE

Clean the metal trim using a water-dampened soft, clean cloth. DO NOT use brass polish or household cleaners as these products will damage the metal trim.

The motors used on the fan and the flame generator assembly are prelubricated for extended bearing life and require no further lubrication. However, periodic cleaning/vacuuming of the fan/heater and air intake/output vents is recommended. The heater should be cleaned and inspected regularly, depending on conditions, and at least at yearly intervals.

**WARNING:** Any electrical repairs of this unit should be carried out by a licensed electrician in accordance with national and local codes.

**WARNING:** Disconnect power by unplugging the power and allowing heater to cool before attempting any maintenance or cleaning to reduce the risk of fire, electric shock, or injury.

**NOTE:** When the heater is not in use, the heater should be stored in a dry location, away from possible damage. The power cord should be stored properly to avoid contact with hot or sharp objects.

# REMOTE CONTROL

The battery compartment is located on the back end of the remote control.

1. Press and slide the battery cover open.
2. Insert two 1.5V (AAA) batteries (included) ensuring they are installed correctly with regard to the polarities (+ and -) marked on the inside of the battery compartment.
3. Replace the battery cover.

**NOTE:** The battery should be removed if the product is to be left unused for a long time.

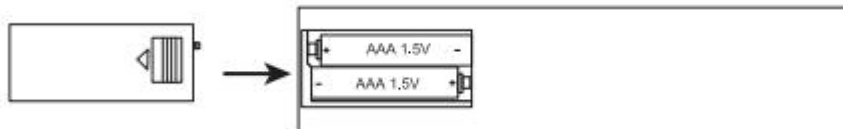

When replacing the batteries, replace both batteries at the same time with new batteries of the correct type.

- Do not mix old and new batteries.
- Do not mix alkaline, standard (Carbon-Zinc), or rechargeable (Nicad, Nimh, etc) batteries.