







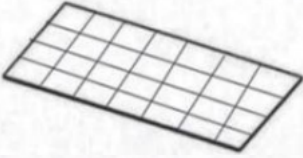

4-TIER STORAGE SHELF

Before getting started, ensure the package contains the following components:

| Part | | Qty |
|----------------------------|--|-----|
| A Beam |  | 8 |
| B Brace |  | 8 |
| C Post |  | 8 |
| D Grid Plates |  | 4 |
| E Protective cover |  | 8 |
| F Anti-tipping Kits |  | 2 |
| G Rubber mallet |  | 1 |
| H Gloves |  | 1 |
| I Support Brace |  | 4 |

Assembly

Step 1:

Insert the protective covers

NOTE: USE A LONG POST AT THE BOTTOM FOR INSTALLATION

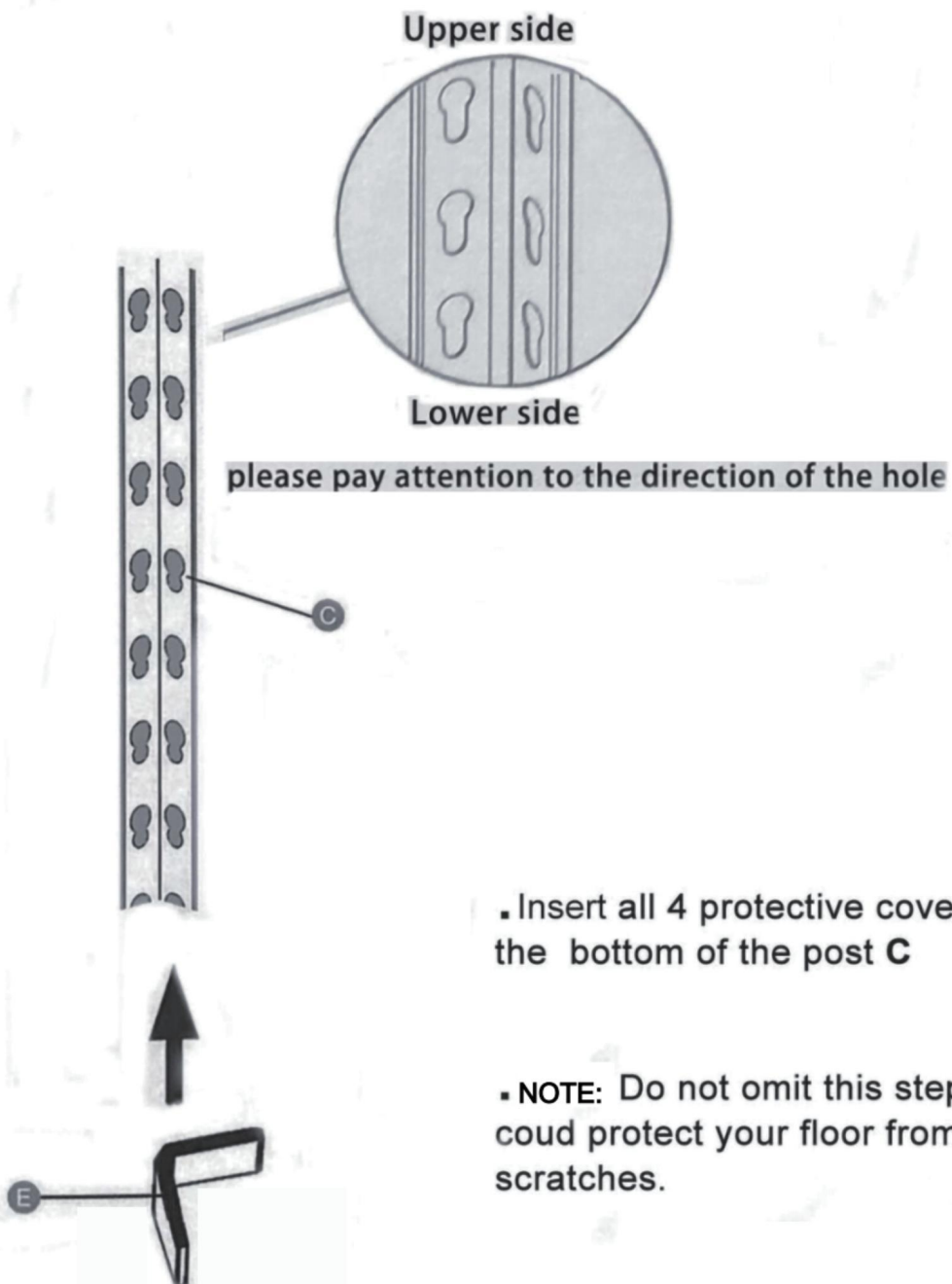

Assembly

Step 2 :

Setting up the brace

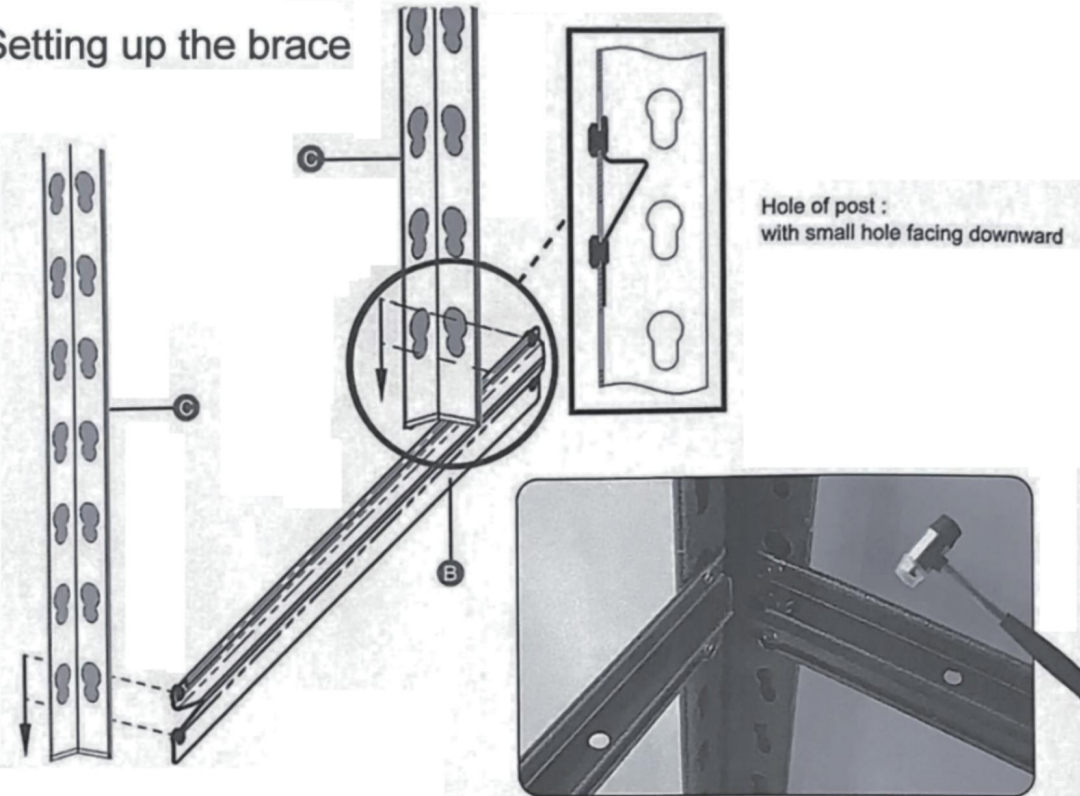

Slide the rivets of brace **B** into posts **C** of your desired location with the key slot pointing down and shelf ledge of brace **B** facing up. Tap lightly to seat rivets.

Note: Make sure all the rivets are fully seated into the post slots. You may want to use a rubber mallet to help push the rivets into the post slots. This applies to all the rivets used in this unit.

Install as follows :

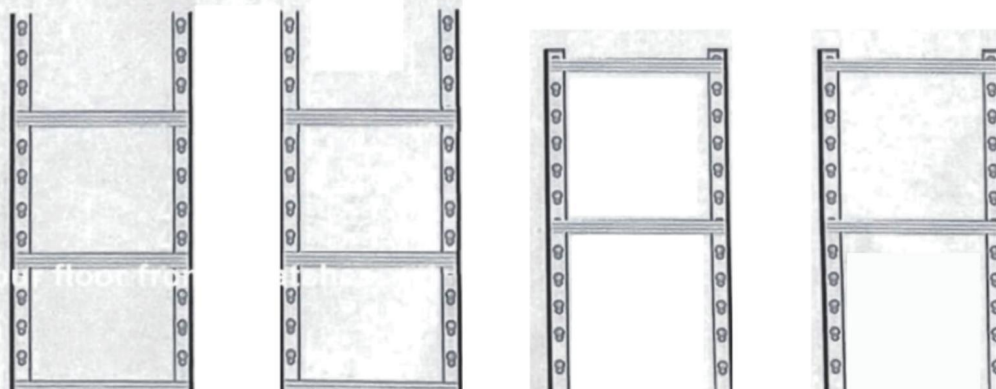

Assembly

Step 3 :

Setting Up the Beams and the Braces

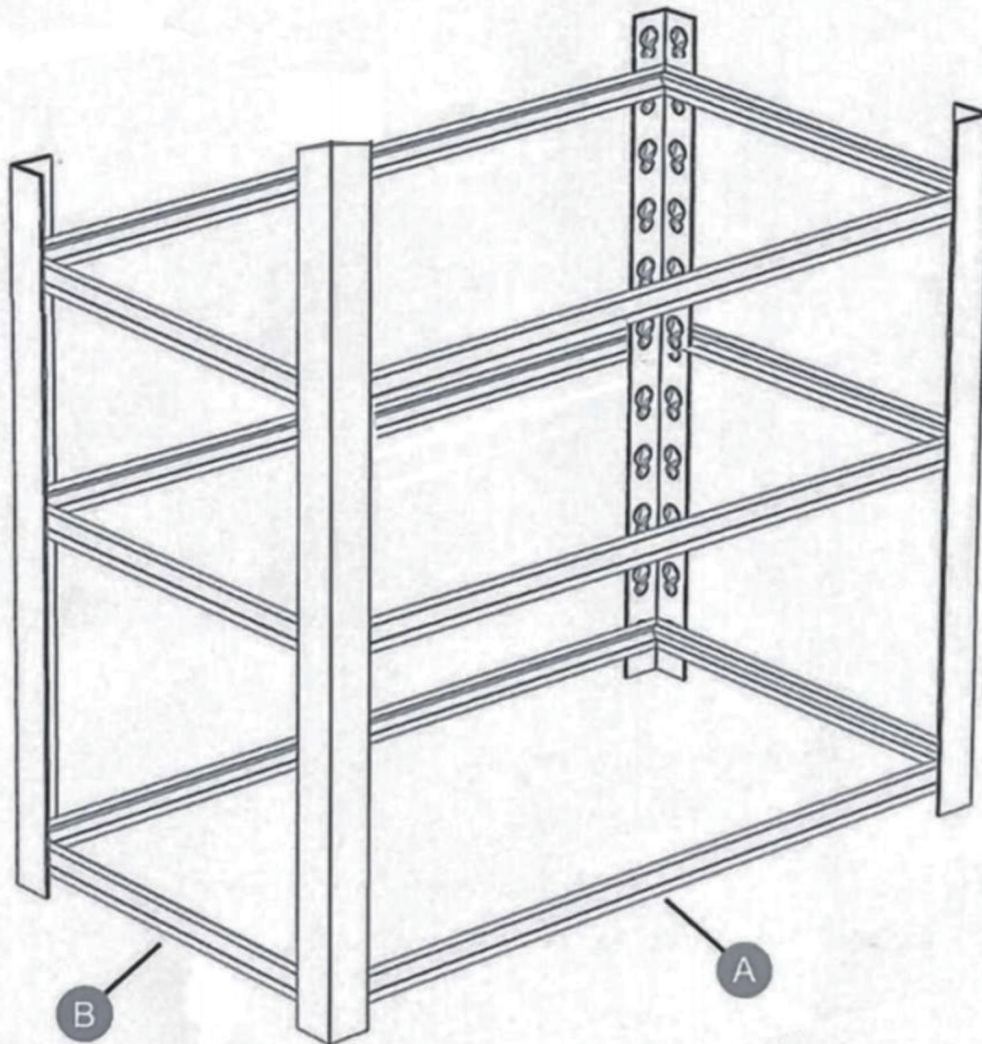

- Repeat the previous step 2 to attach beams **A** and braces **B** to posts **C** until the first and the second levels are assembled .
- **Note:** Each of the beams **A** and braces **B** on the same level should be at the same height.

Assembly

Step 4 :

Setting Up the remaining Beams and Braces

Setting up the support braces

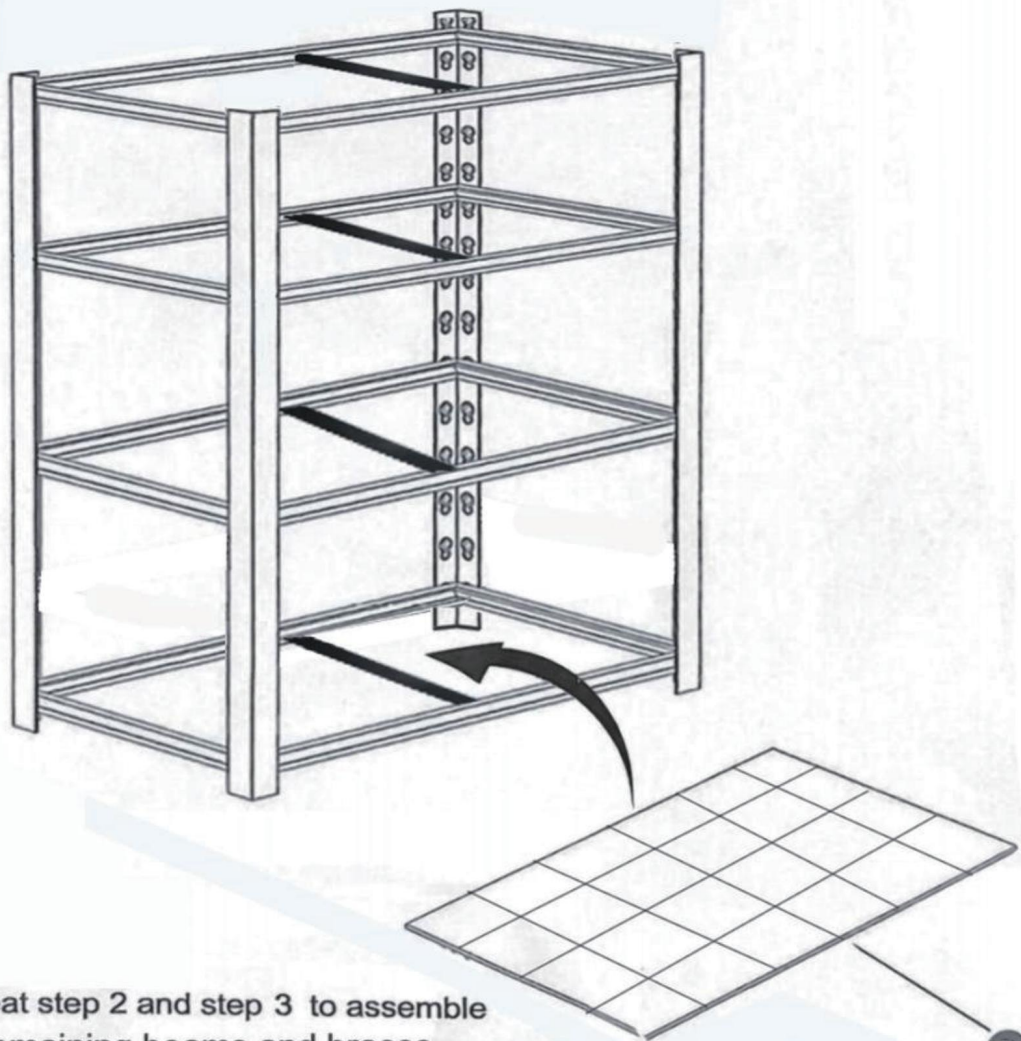

- Repeat step 2 and step 3 to assemble the remaining beams and braces
- Hold the press board at an angle to make it easier to fit them onto each previously assembled level on the frame.

Assembly

Step 5:

Setting up the anti-tip kit



Anti-tip Kit



- Secure the anti-tip kit to the wall with screws



- Pass the fixing strap through the anti-tip kit

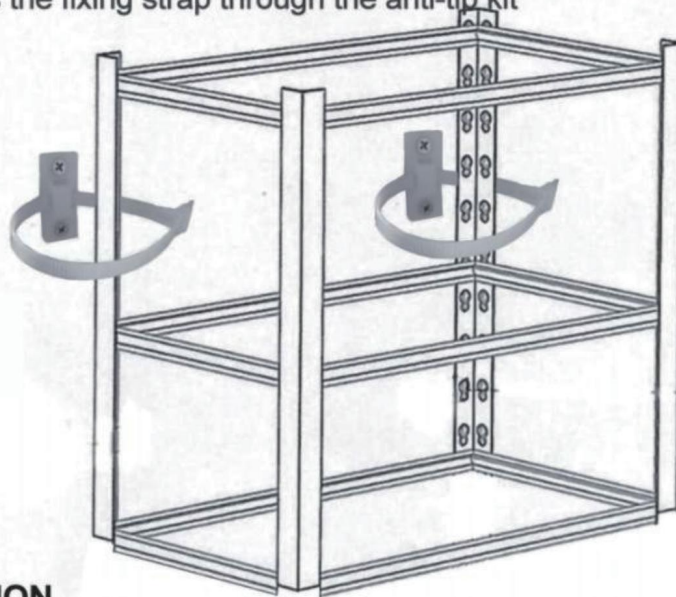

CAUTION

- Be aware of dynamic loading! sudden load movement may briefly create excess load causing product failure.
- Evenly distribute the weight on each shelf, and keep the heaviest loads on the bottom shelf.
- Use only on flat, level and hard surface capable of supporting the shelving and any items placed on it, Remember to only use the shelf on level ground with evenly distributed weight.
- Do not store flammable liquids in the unit unless they are secured in an approved container.
- Keep bystanders out of the area during assembly.
- This product is not a toy. Do not allow children to play with, on or near the unit.