

15'

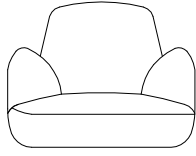

1

A



x 1

B



x 4

A

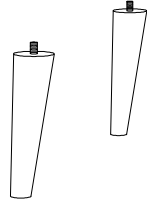
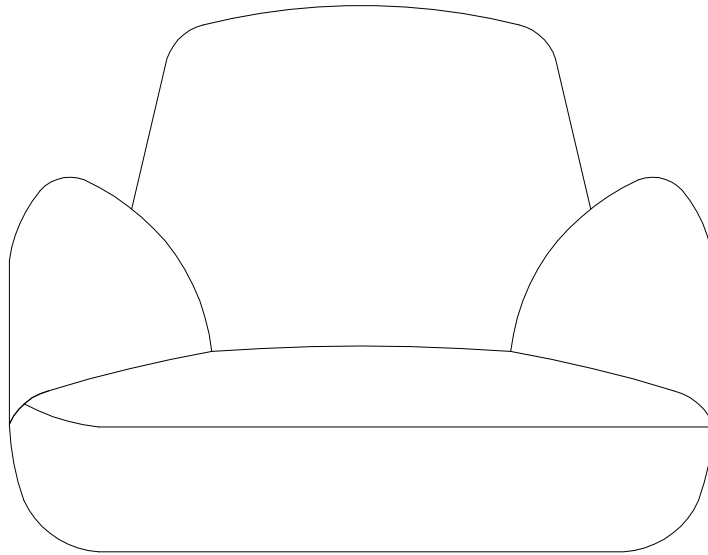

B x 4

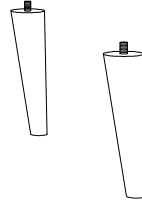

!

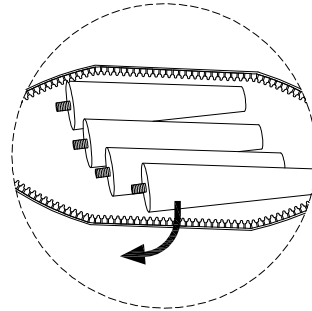
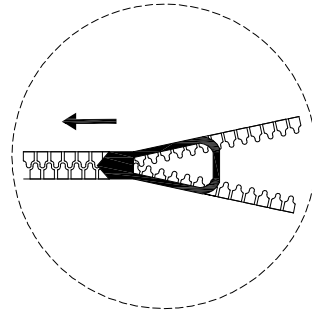
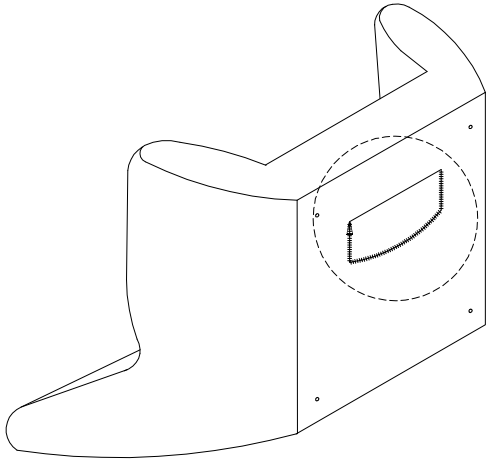

1

A

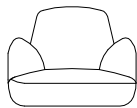

x 1

B



x 4

