

ASTI DINING TABLE

ASSEMBLY GUIDE

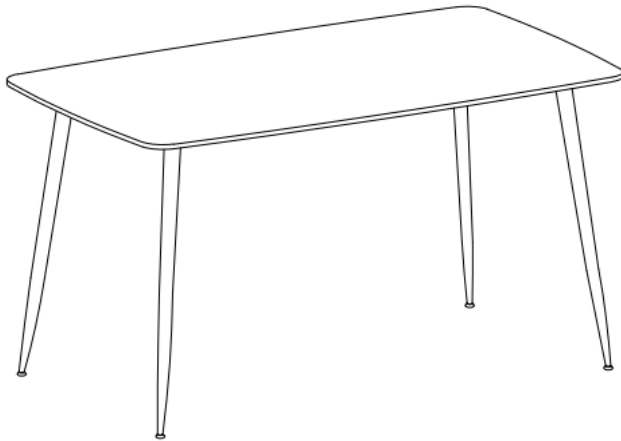

www.furniturebox.co.uk

Scan QR code for more tips,
advice and assembly video or visit
furniturebox.co.uk/club/general-club-page

Important - Please read these instructions fully before starting assembly



**SAFETY AND
CARE ADVICE**



NO POWER TOOLS

SAFETY AND CARE ADVICE

- Check you have all the components and tools listed.
- Remove all fittings from the plastic bags and separate them into their groups.
- We do not recommend the use of power drills/drivers for inserting screws, as this could damage the unit. Only use hand screwdrivers and Allen keys.
- Keep children and animals away from the work area, small parts could cause choking if swallowed.
- Make sure you have enough space to lay out the parts before starting.
- Assemble the item as close to its final position (in the same room) as possible.
- Do not overtighten the nuts to avoid causing damage to the threads.
- Only clean using a damp cloth and mild detergent, do not use bleach or abrasive cleaners.
- From time to time check that there are no loose screws on this unit.
- This product should not be discarded with household waste. Take to your local authority waste disposal centre.



IMPORTANT INFORMATION



20 MINUTE
BUILD



TWO
PERSON



MAXIMUM CAPACITY
75Kg

PLEASE CHECK CAREFULLY AND MAKE SURE YOU HAVE ALL FITTINGS
AND TOOLS LISTED BELOW BEFORE YOU START.

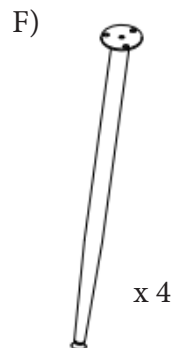
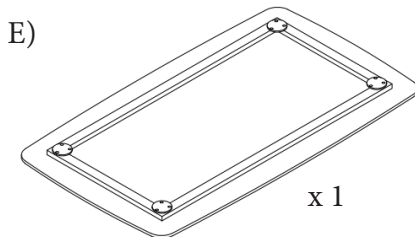
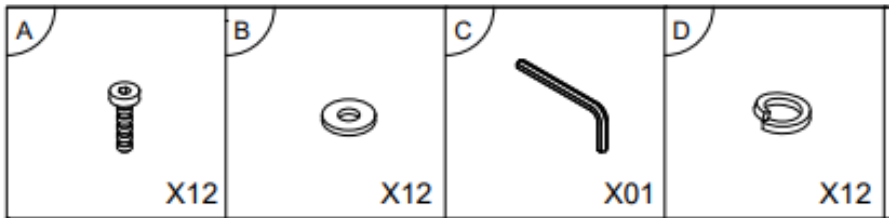

NOTE: The quantities above are the correct amount to complete the assembly. In some cases more fittings may be supplied than are required.

STEP 1

Use a clear, flat, soft surface to avoid bumps or scratches. Lay all your components and fixings out.

Place 1 x table top [E] upside down. Align the pre-drilled holes in the 4 x table legs [F] with the pre-drilled holes in the underside of [E] and secure using 12 x washers [B] plus 12 x screws [A] and 12 x nuts [D]. Fully tighten the screws and nuts with allen key [C].

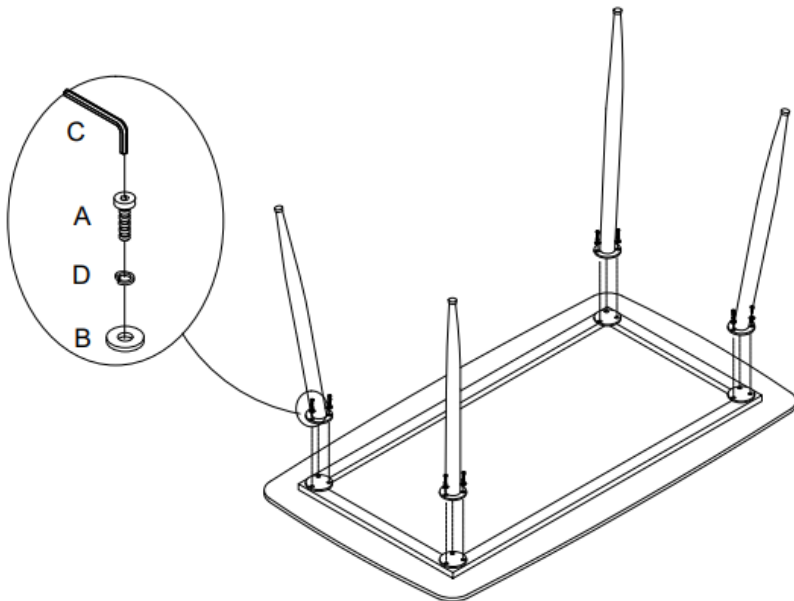

STEP 2

Carefully turn the table over onto its legs.
Check the stability.

Your table is now ready to use!

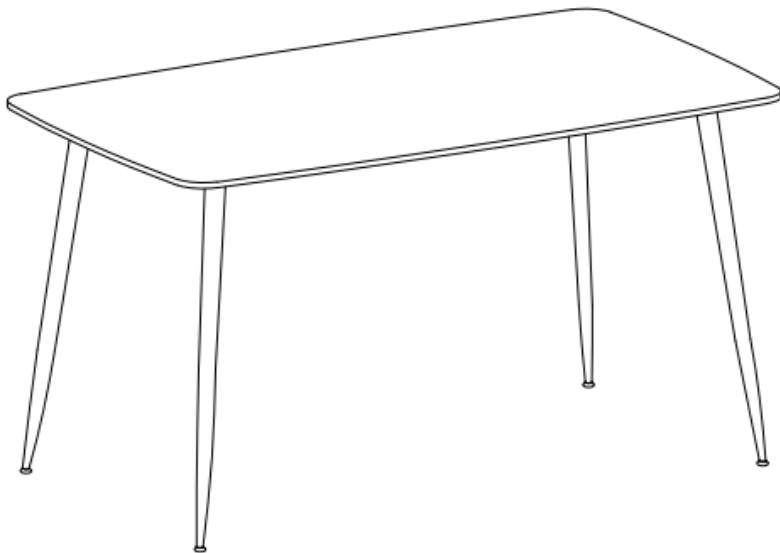

Looking Good!

Now you've assembled your furniture, find out how to care for your item and keep it looking brand new.



Product Care Handbook: A Guide To Protecting Your Product

product CARE ADVICE

At Furniturebox, all of our products are subject to our rigorous quality testing procedure to ensure that the highest possible standards are met. As a result, we're really proud of the fact that all of our products arrive with our customers quality assured, conforming to all UK regulations and complete with up to a 2 year manufacturer's guarantee. In the unlikely event that your item

does arrive to you with a damage or defect, please do let us know within the first 7 days so that we can resolve it for you as quickly as possible. You can read the full details of our guarantee on our website, but in order to ensure your product continues to look as good and function as flawlessly as the day you received it, please do take note of the relevant product care advice.

caring for MIRRORED SURFACES

When cleaning your mirror it is best to avoid liquids and instead use a dry, clean cloth.

The use of an abrasive cleaning product can damage the mirror surface and edges. Do not use any acidic or alkali cleaning product. Likewise, ammonia-based cleaning products can seriously damage your mirror and should be avoided.

To reduce the chances of surface scratches, be sure to use a soft, grit-free cloth for all cleaning purposes.



GENERAL USAGE ADVICE

Please read the product assembly guide thoroughly, making sure to follow all instructions carefully and accurately.

Take note of the relevant cleaning and maintenance advice provided for specific product materials.

Only use your product on firm, level ground and do not exceed the recommended maximum load weight detailed in your assembly guide.

To preserve the items cosmetic appearance, please avoid exposing your product to direct, intense sunlight for prolonged periods of time. Where applicable, make use of the anti-rusting mechanism included to ensure tables are stable and safe.



For more product care



Need Inspiration? Follow us on [Facebook](#) [Instagram](#) [Twitter](#) [Pinterest](#)

www.furniturebox.co.uk

PRODUCT Care Guide

IMPORTANT INFORMATION INSIDE

A handy guide for how to get the best out of your new furniture

www.furniturebox.co.uk

Look for your care guide in the box or visit:
www.furniturebox.co.uk/club/care-guide

let's stay **IN TOUCH**

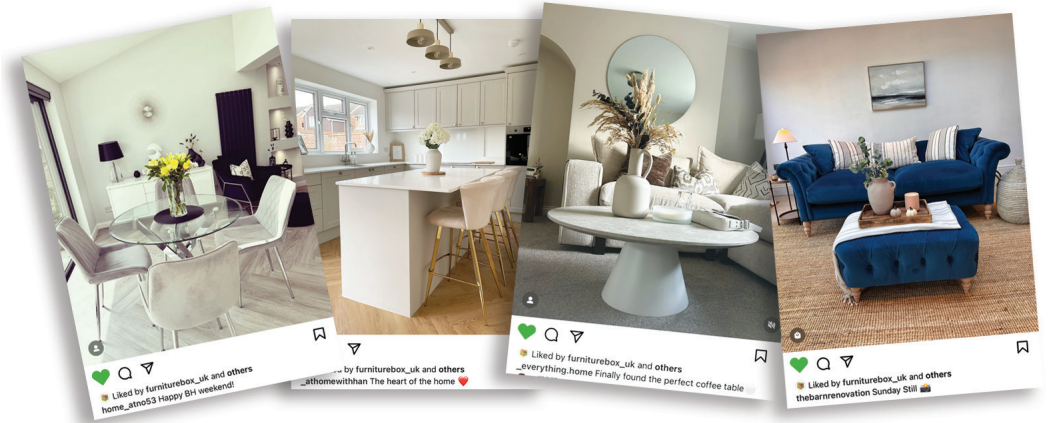

WE **LOVE** INTERIORS! SHARE
YOURS WITH US ON SOCIAL MEDIA

1. Follow us on our socials |
2. Post your snap or video
3. Tag us so we can see (and for a chance to be featured!)



@furnitureboxUK



@furniturebox_uk



@furnitureboxuk



@furniturebox_uk



follow us on Instagram
@furniturebox_uk

www.furniturebox.co.uk



Our 1 Year **GUARANTEE**

Our products come with a 1 year guarantee, giving you extra peace of mind when shopping with us!

What the guarantee covers



PRE-INSERTED FIXINGS
e.g. lose metal threads



FAULTY JOINTS
e.g. legs bending



EXTERNAL FIXING FAULTS
e.g. metal discs removing
from table top



STRUCTURAL INTEGRITY
e.g. the frame of the
product

Activate Your **GUARANTEE**



Scan this QR code with your phone to read the full guarantee online and register your product. It only takes a moment to fill out.

Or visit: furniturebox.co.uk/our-guarantee