

ASSEMBLY INSTRUCTION

ITEM NO. PSHHPC024BK1C1

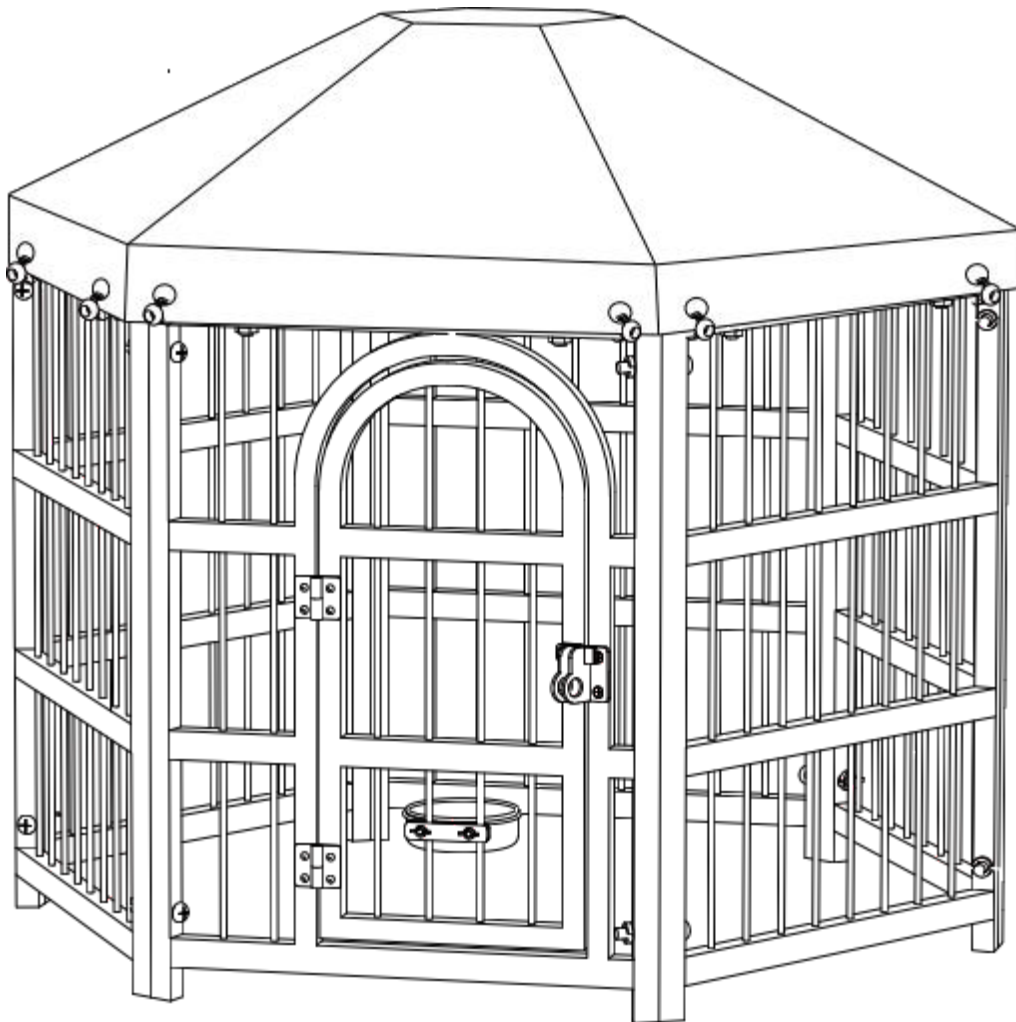

IMPORTANT NOTICE

1. Pre-Assembly Preparation

Before beginning assembly, clear and illuminate your workspace to ensure a clean, flat surface.

2. Read Instructions Thoroughly

Read all assembly instructions completely before starting. Incorrect assembly may compromise the structural integrity of the crate, posing risks of pet escape or injury.

3. Use Correct Tools and Tighten Appropriately

Use only the tools provided or recommended. When tightening screws, apply moderate force. Overtightening may crack plastic components or strip metal threads.

4. Ensure Absolute Stability of the Crate

Once assembled, test the crate's stability by firmly shaking it. For large or tall crates, position them against a wall on a stable surface. NEVER place the crate on elevated surfaces such as tables or countertops, as pet activity may cause it to fall.

5. Beware of Small Parts and Packaging Materials

During and after assembly, immediately dispose of all small parts (e.g., screws, nuts), plastic bags, foam, and other debris. Store them out of reach of children and pets to prevent choking hazards or accidental ingestion.

6. Safe Handling

The crate may be heavier than it appears. When moving or transporting it, seek assistance, grip the sturdy frame (not the door or bars) firmly to avoid deforming the door or pinching your fingers.

7. Regular Safety Inspections

Before each use, periodically check:

- Whether door latches and bolts are securely fastened and functioning correctly.
- For any cracks or corrosion at weld joints and connection points.
- For any bent, broken, or sharp burrs on the bars.

If any damage is found, stop use immediately and repair or replace the crate.

Following these guidelines will provide a secure and stable foundation for your pet's enclosure.

CARE AND CLEANING

Many household cleaners contain harsh chemical or abrasive substances that may damage the surface coating or material of this product. Please clean using mild soapy water. After cleaning, thoroughly dry the crate with a clean, soft cloth.

Place the dog crate in a well-ventilated area and try to avoid prolonged exposure to damp conditions. If possible, regularly move the crate outdoors or to a ventilated spot to air it out. This helps maintain dryness and hygiene, extending the product's lifespan.

This dog crate is treated with anti-corrosion coating and can withstand normal moisture and humidity from daily pet use. However, to maintain its optimal condition, it is recommended to frequently wipe away any water spills and reduce overall humidity by ensuring good ventilation in the environment.

Maintenance of Door and Moving Parts: Regularly clean the door tracks, locks, and other moving parts with a soft cloth to remove hair and dust, ensuring smooth operation. If water droplets are present on the surface, wipe them dry promptly with a cloth. Do not place the crate near open flames, heaters, or other high-temperature sources.

Safety Warning: Do not allow children to climb, shake, or sit on the dog crate. Adults should also avoid leaning on or attempting to stand on it, as this may cause the crate to tip over or its structure to become damaged, potentially resulting in injury to people or pets.

NOTE :







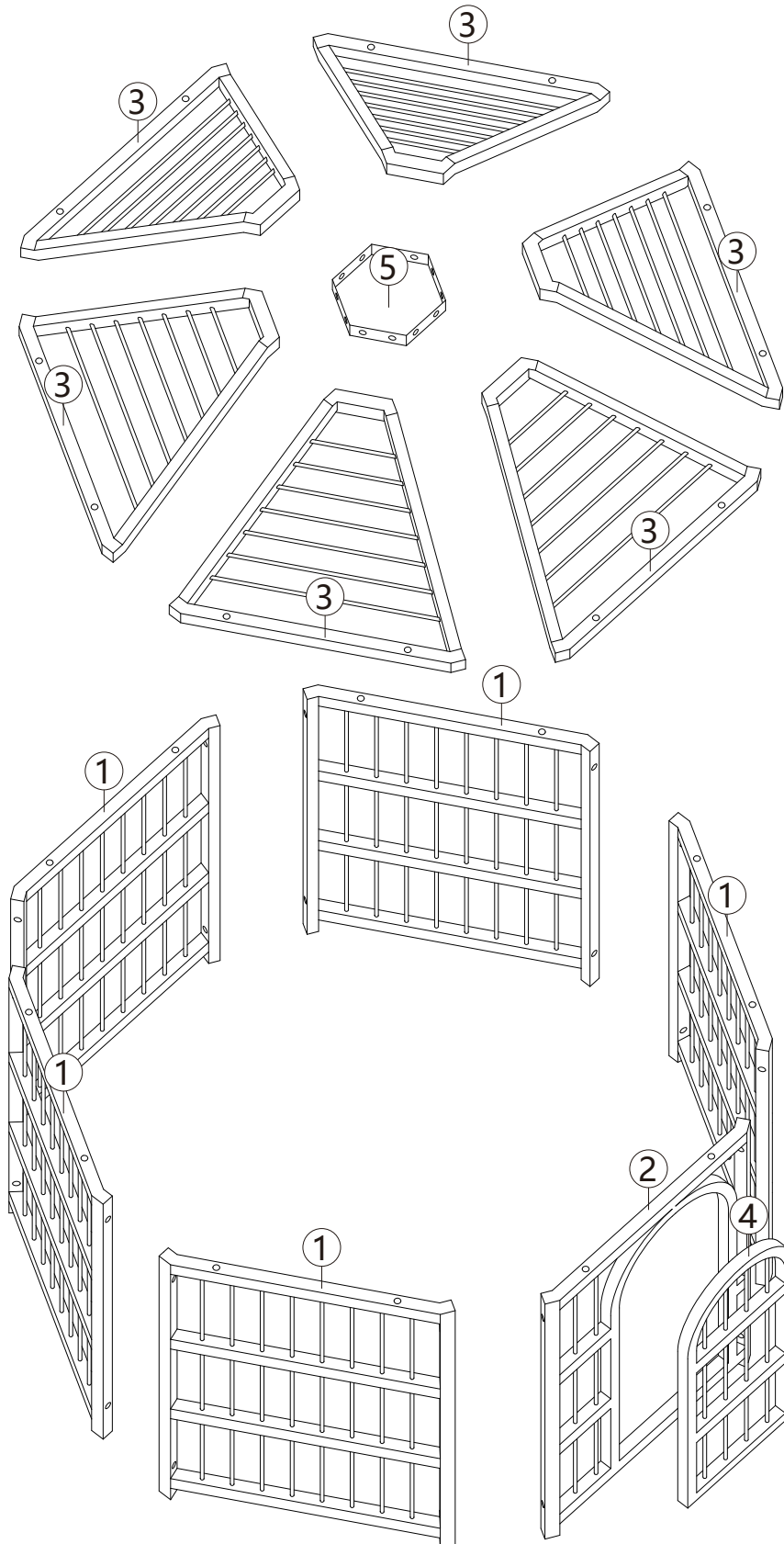

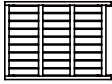

Initially, only hand-tighten the screws to leave enough room for minor adjustments during alignment. Tighten everything securely once the frame is complete.

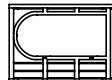
ASSEMBLY DIAGRAM

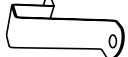

1. Refer to the exploded view below for the approximate location of each component.
2. Each part is labeled for easy identification.
3. Follow the assembly instructions carefully to ensure proper installation.



PARTS LIST

No.	Description	QTY	No.	Description	QTY
1		5	9		12
2		1	10		1
3		6	11		5
4		1	12		5
5		1			
6		1			
7		2			
8		1			

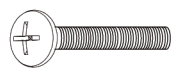
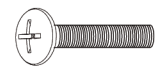
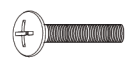
HARDWARE LIST



No.	Description	QTY
A	 M6*45	24
B	 M6*20	12
C	 M4*14	12
D	 M6	24

CAUTION: Please confirm the parts list before installation

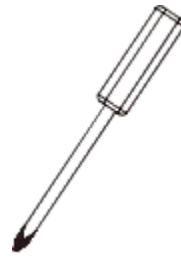
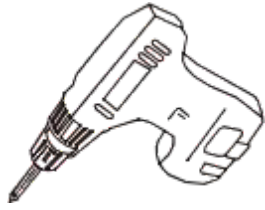
YOU MAY NEED (NOT SUPPLIED)

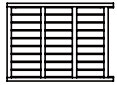
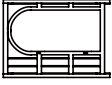

1

 5 PCS	 1 PCS	 M6*45 12 PCS	 12 PCS
--	--	--	---

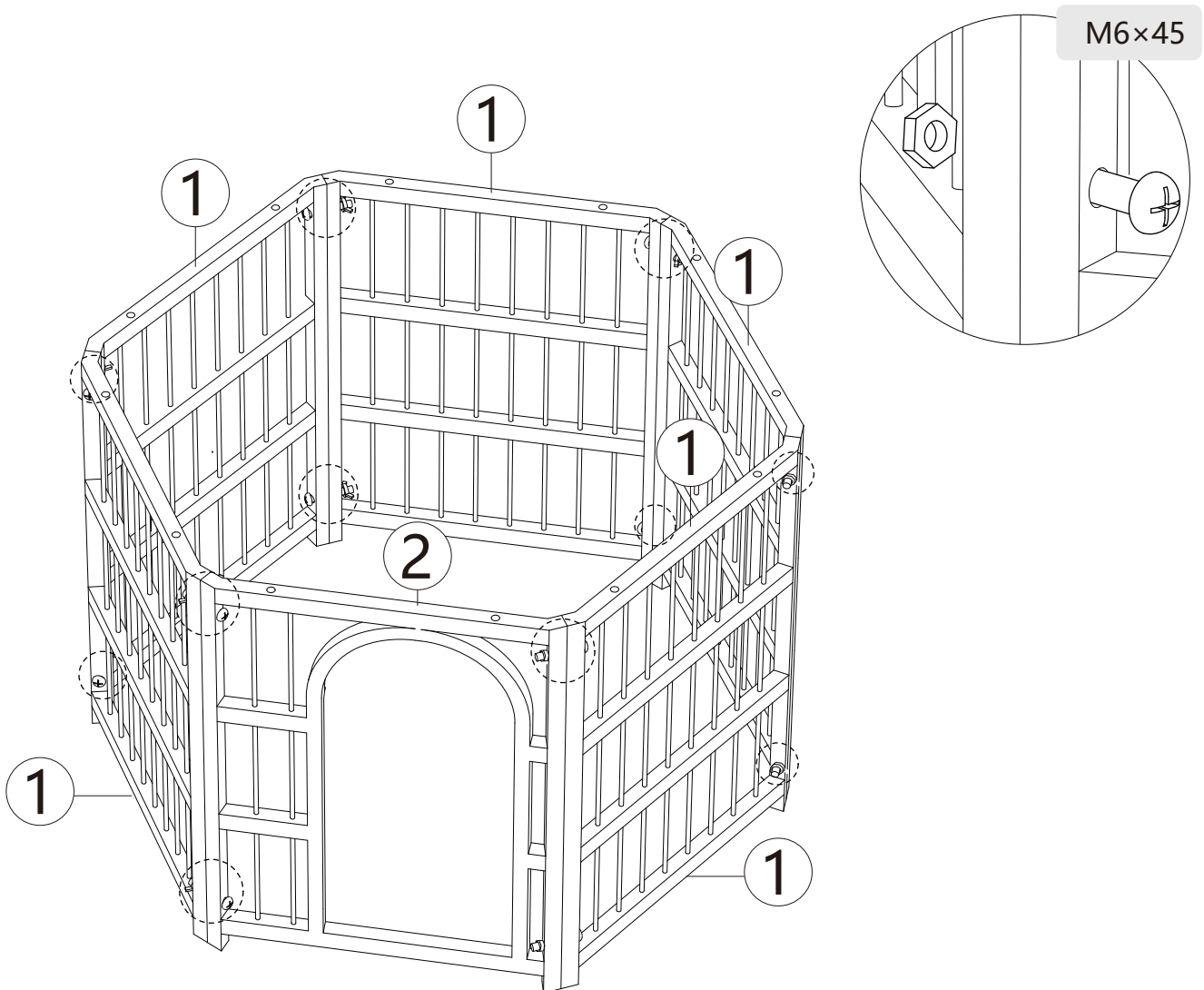

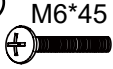

2

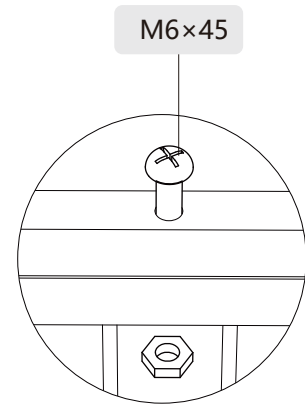
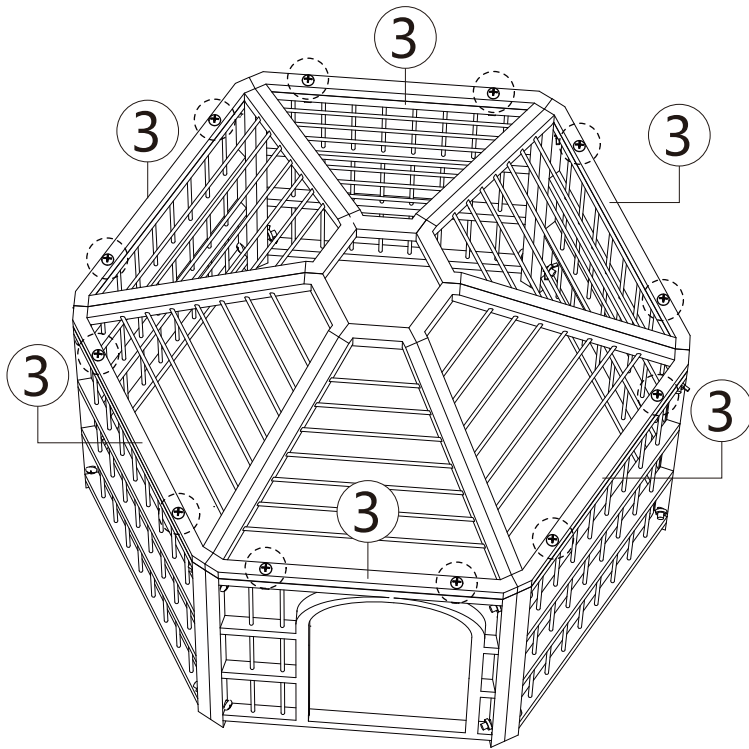
 6 PCS	 12 PCS	 12 PCS
--	---	---



3

 1 PCS	 12 PCS
--	---

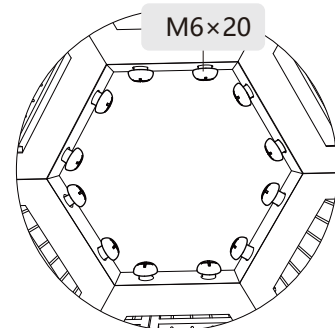
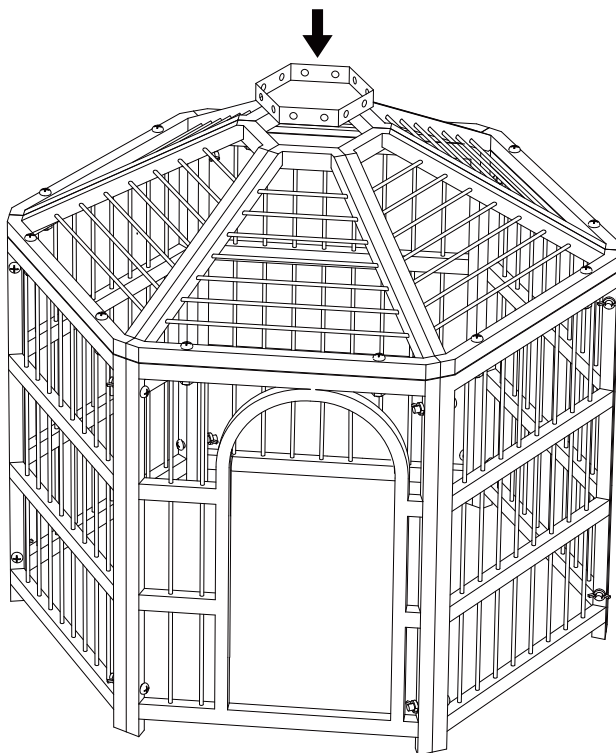

4

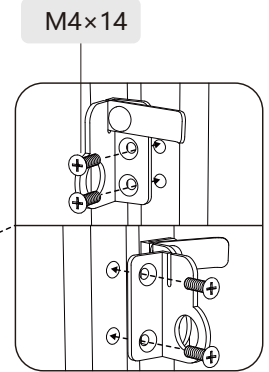
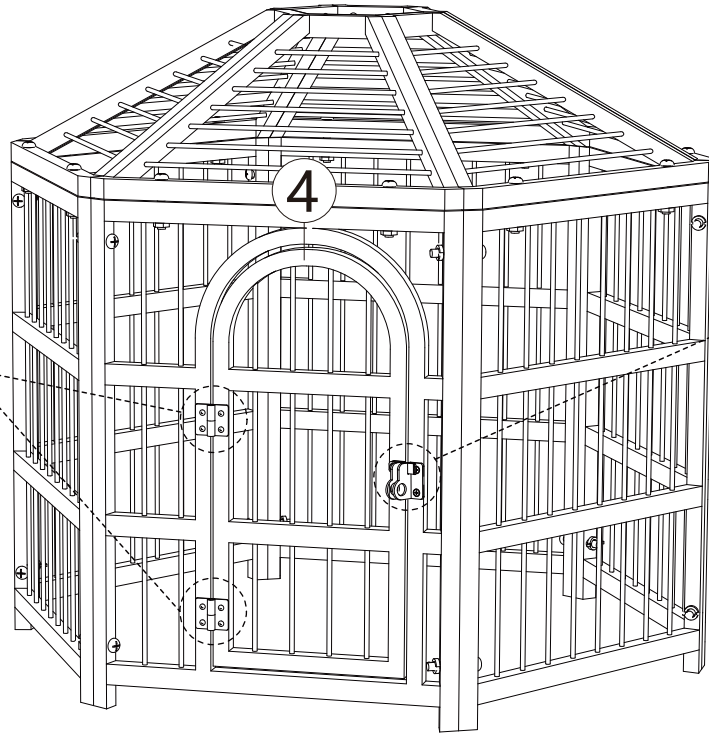
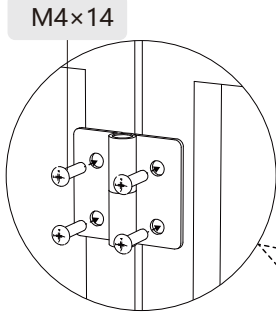
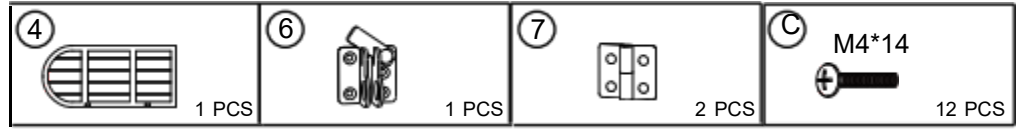

5

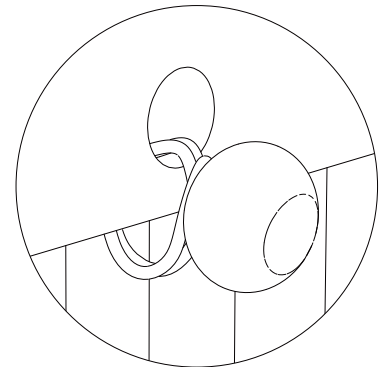
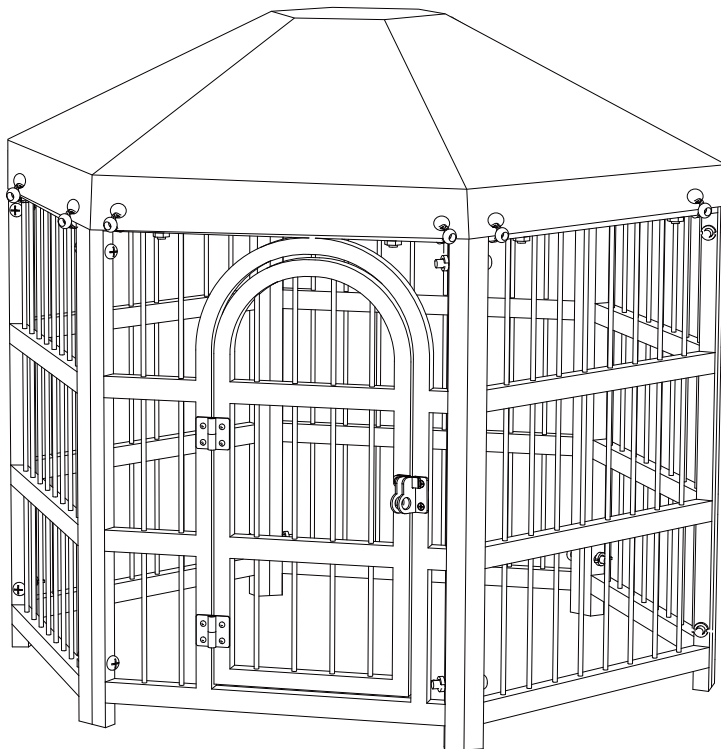
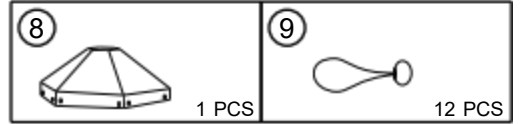

6

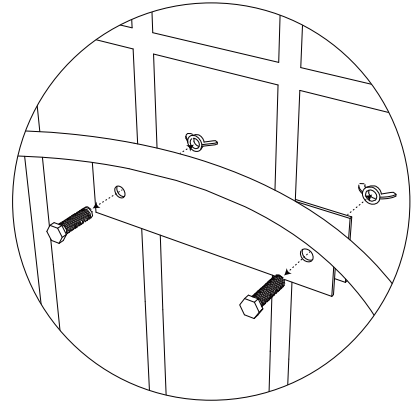
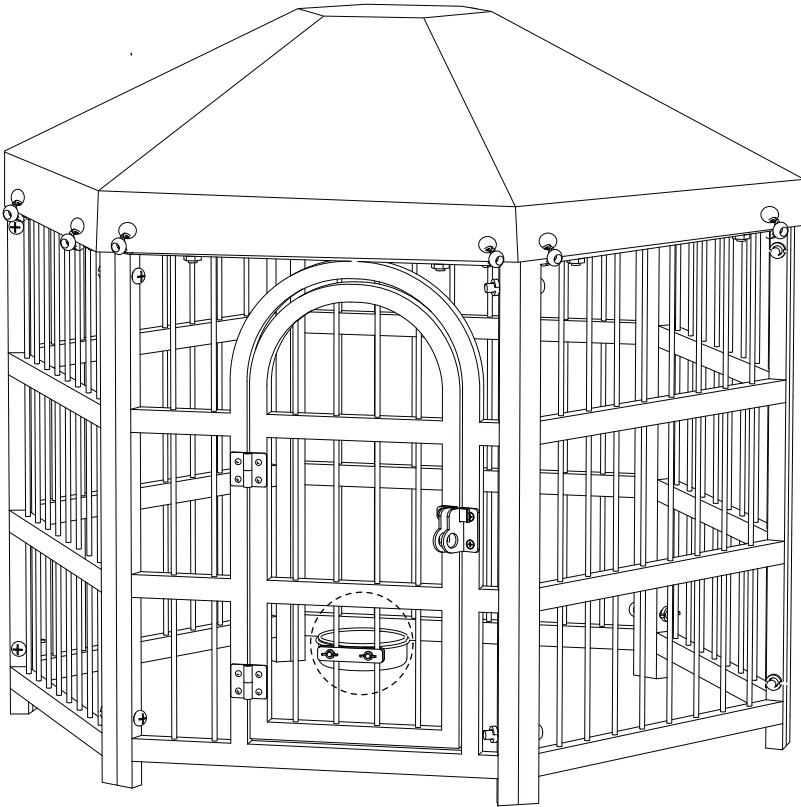

7

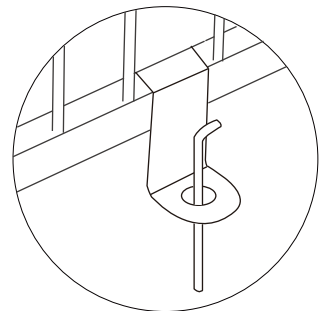
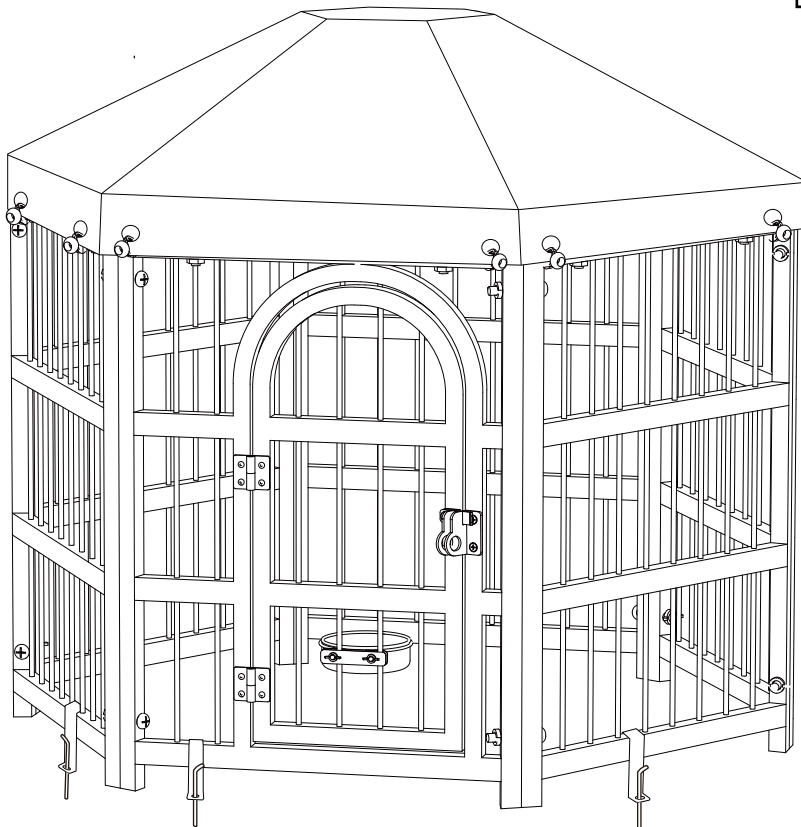
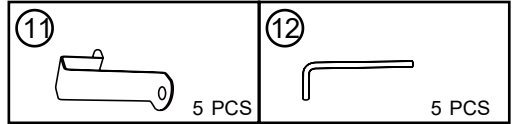

THANK YOU

Thank you for choosing our product. We sincerely hope that the assembly process has been smooth and enjoyable for you. If you have any questions or suggestions during the use of the product, please feel free to contact us.

Contact number: (323)-393-8260 at EST 9AM-1PM

E-mail: nxyb.yw.amz@outlook.com

