

# Instruction Manual

## Aspen Wooden Arm Chair PCK2

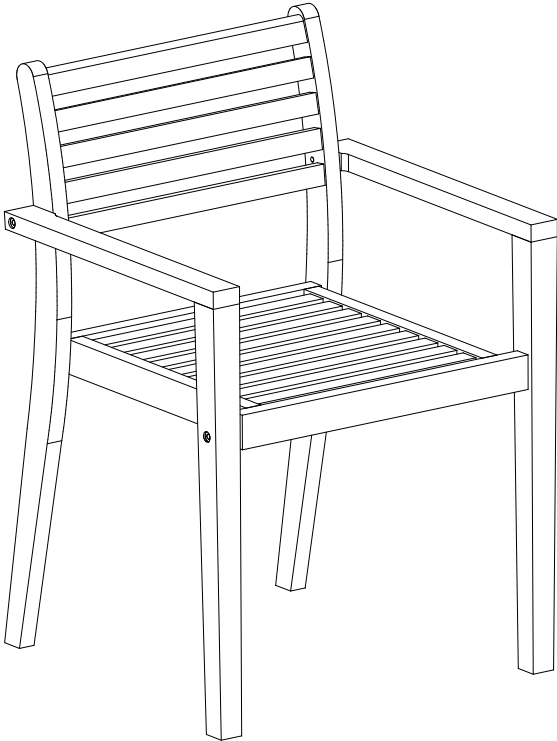

# CONTENTS

---

Safety and care advice	<b>1</b>
Components	<b>2</b>
Assembly instructions	<b>4</b>
Copyright	<b>8</b>

# ⚠ SAFETY AND CARE ADVICE ⚠

---

## PLEASE READ THESE INSTRUCTIONS CAREFULLY AND KEEP FOR FUTURE REFERENCE

- **Warning:** Please lift with care.
- Check you have all the components and tools listed on pages 2 and 3.
- Remove all fittings from the plastic bags and separate them into their groups.
- Keep children and animals away from the work area, small parts could choke if swallowed.
- Make sure you have enough space to lay out the parts before starting.
- Do not stand or put weight on the product, this could cause damage.
- Assemble the item as close to its final position (in the same room) as possible.

- Assemble on a soft level surface to avoid damaging the unit or your floor (use opened out unit carton).



- We do not recommend the use of power drill/drivers **for inserting screws**, as this could damage the unit. Only use hand screwdrivers.
- Dispose of all packaging carefully and responsibly.

## CARE AND MAINTENANCE

---

- Only clean using a damp cloth and mild detergent, do not use bleach or abrasive cleaners.
- From time to time check that there are no loose screws on this unit.

- This product should not be discarded with household waste. Take to your local authority waste disposal center.

**Note** *If required the next page can be cut out and used as reference throughout the assembly. Keep this page with these instructions for future reference.*

# COMPONENTS

Please check you have all the panels listed below:

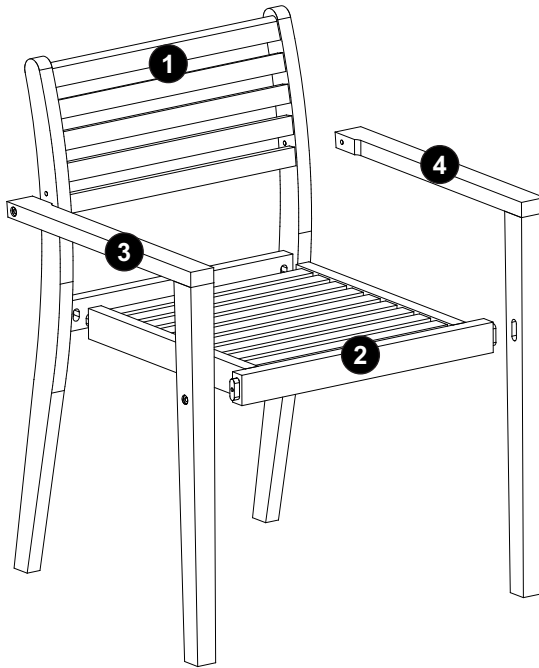

1. Back frame	x 1
2. Seat	x 1
3. Right side frame	x 1
4. Left side frame	x 1



# COMPONENTS

---

Please check you have all the fittings listed below:

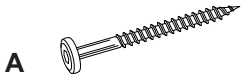

Screw ( $\Phi 7 \times 90 \text{mm}$ ) x 2

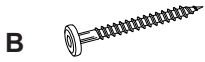

Screw ( $\Phi 7 \times 70 \text{mm}$ ) x 2

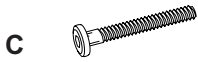

Bolt ( $\Phi 8 \times 70 \text{mm}$ ) x 2

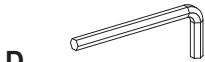



Allen key x 1



# ASSEMBLY INSTRUCTIONS

---

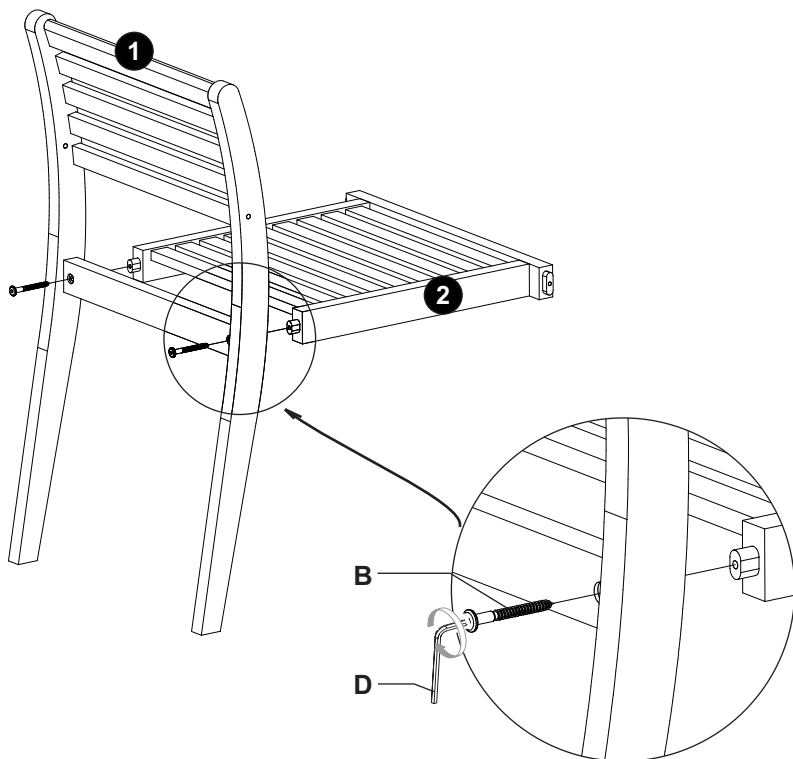

## Step 1

B		2	
D		1	



# ASSEMBLY INSTRUCTIONS

## Step 2

A		2	
C		2	
D		1	

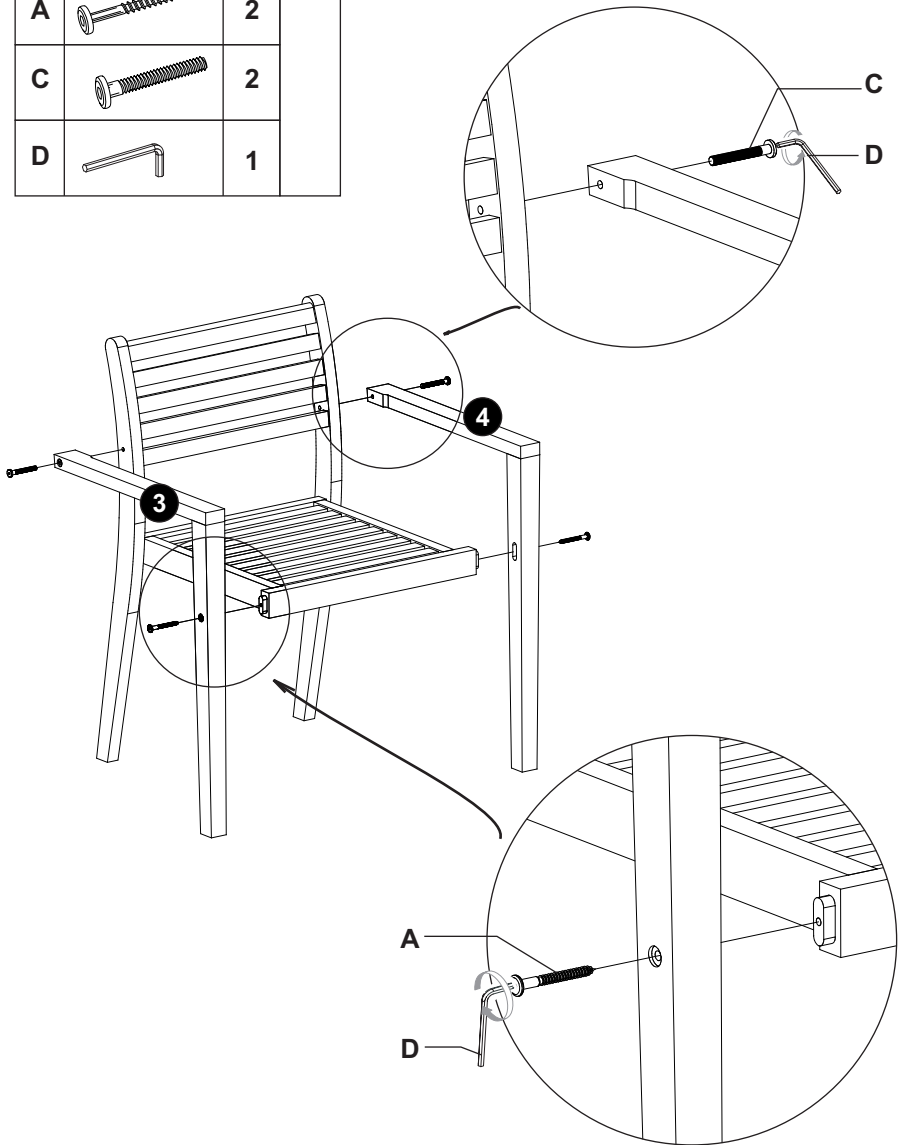

# ASSEMBLY INSTRUCTIONS

---

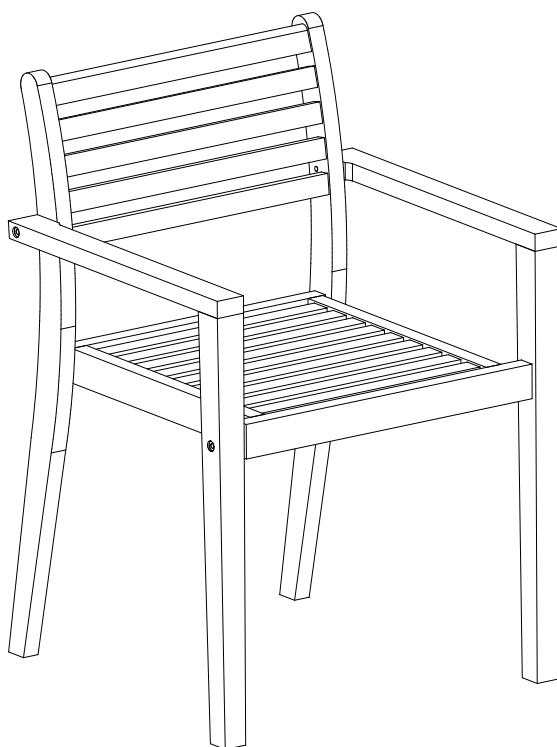

Congratulations! Now you have finished assembling the product.

## **IF YOU FIND A DEFECTIVE PART**

---

We fully stock all parts and components. Any defective part can be quickly replaced. Take note of the defective part number in manual and we will arrange a quick replacement.

You can email our team

## **COPYRIGHT**

---

All material in this instruction manual is copyrighted

Any unauthorised use may violate worldwide copyright, trademark and other laws.