



ASSEMBLY INSTRUCTION

CHAIR

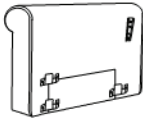
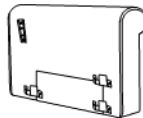

Legs and hardware are stored in box,
please take out for assembly.

NOTE: Do not use power tools for assembly. Power tools increase the risk of over tightening which lead to splitting or cracking the wood.

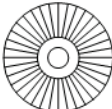
NO.	DRAWING	QTY	DESCRIPTION
A		1	Seat
B		1	LSF Armrest
C		1	RSF Armrest
D		1	Back Rest
E		4	Plastic Leg
F		4	Plastic Washer

Exploded View

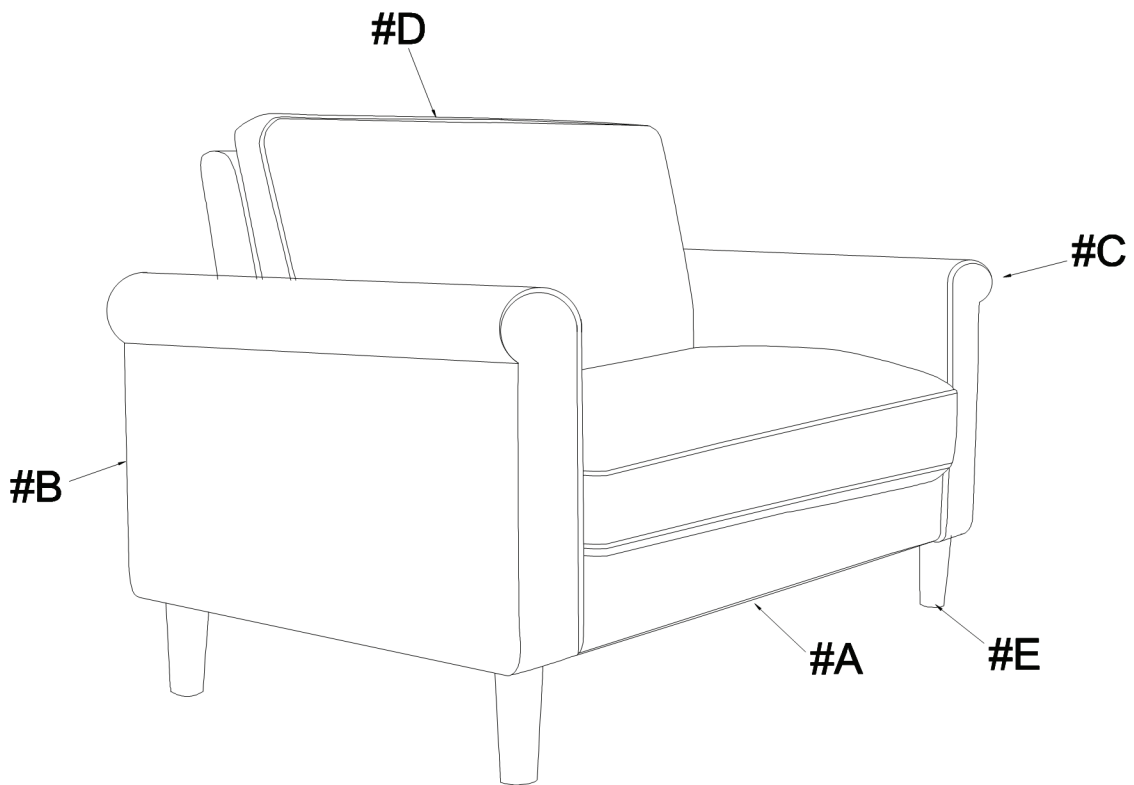

STEP 1:

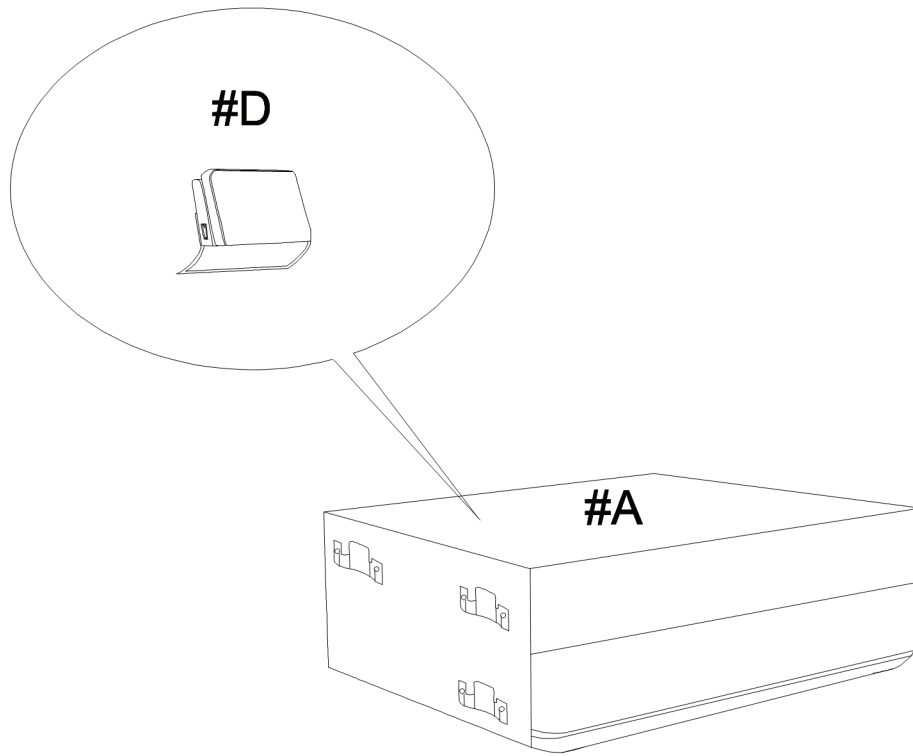

STEP 2:

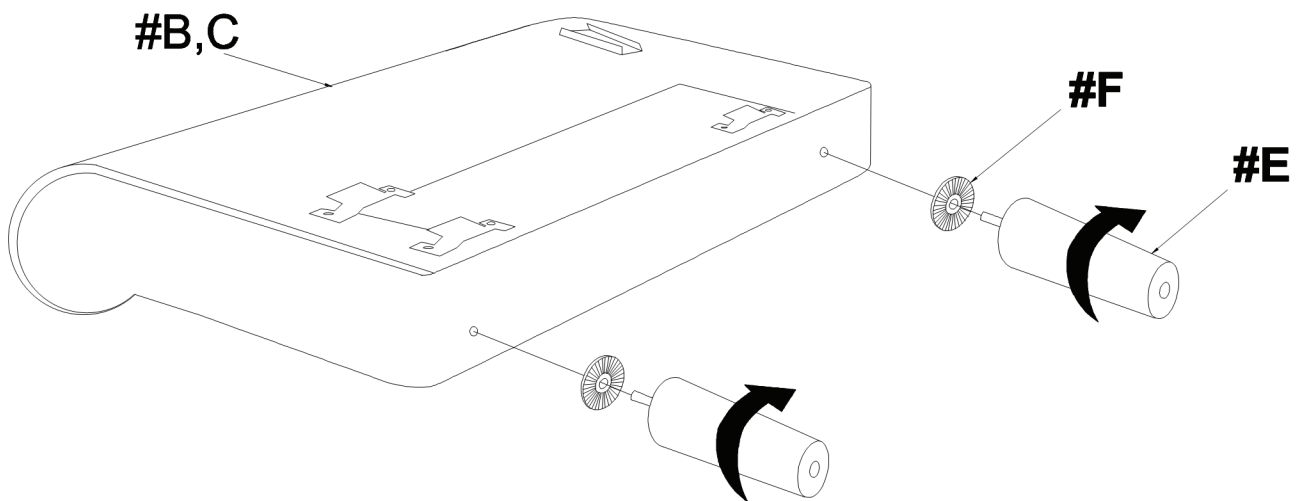

STEP 3:

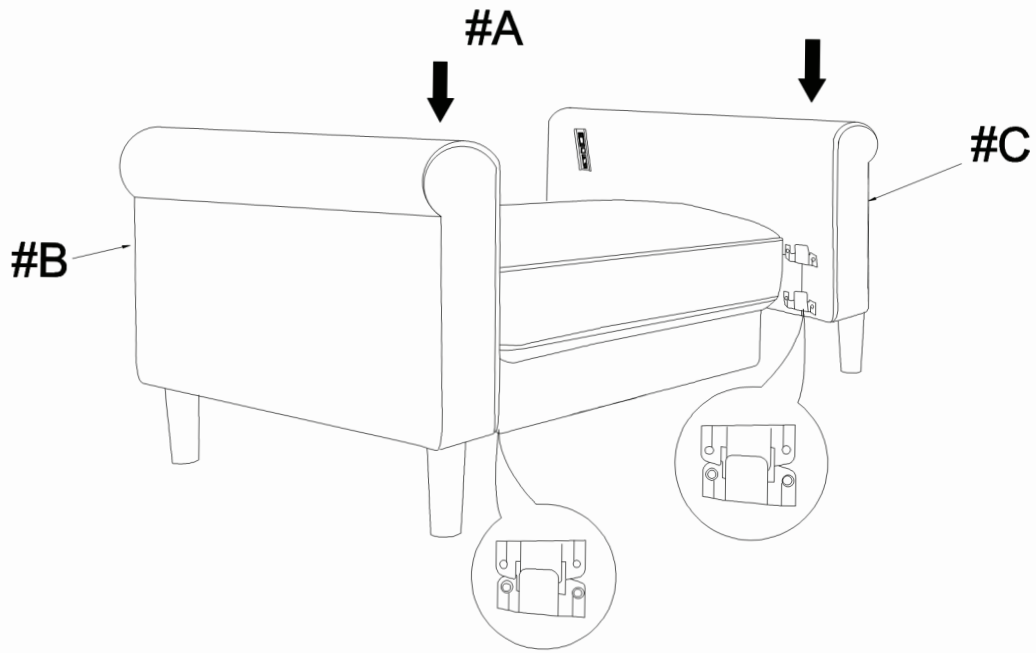

STEP 4:

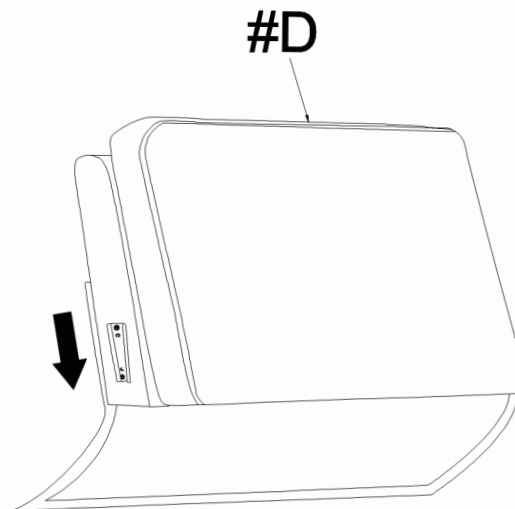

STEP 5:

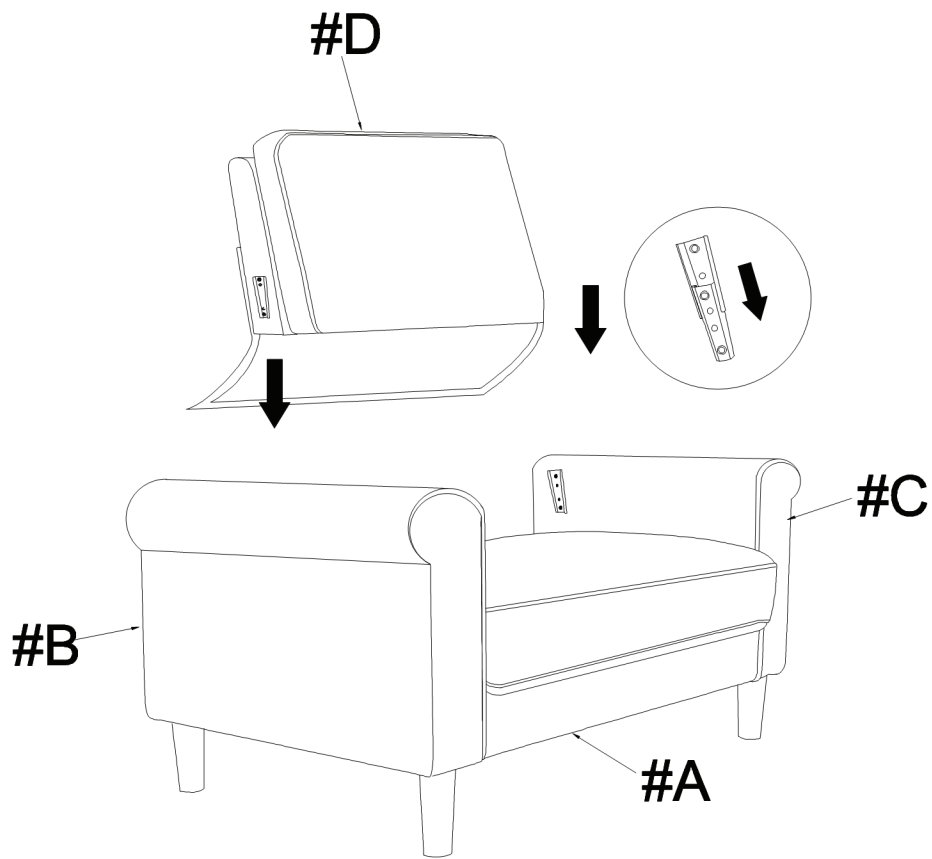

STEP 6:

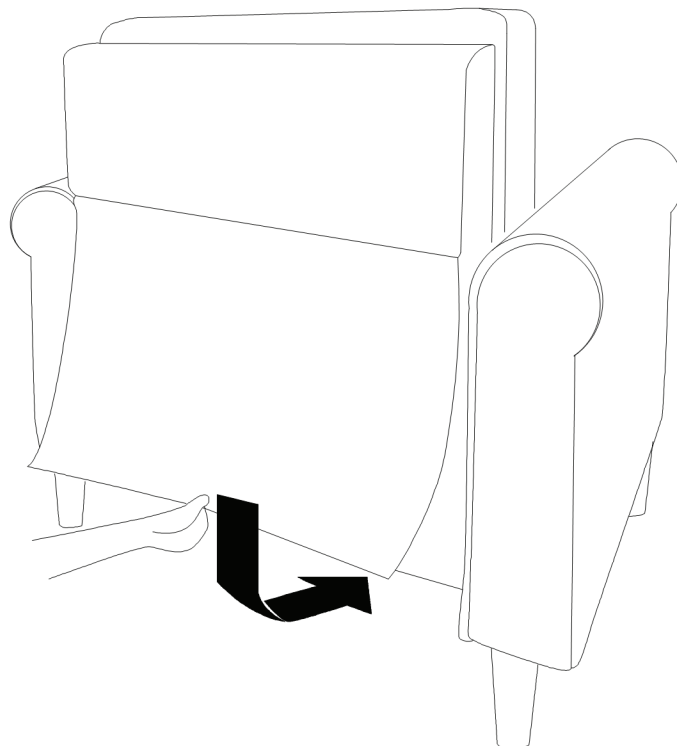

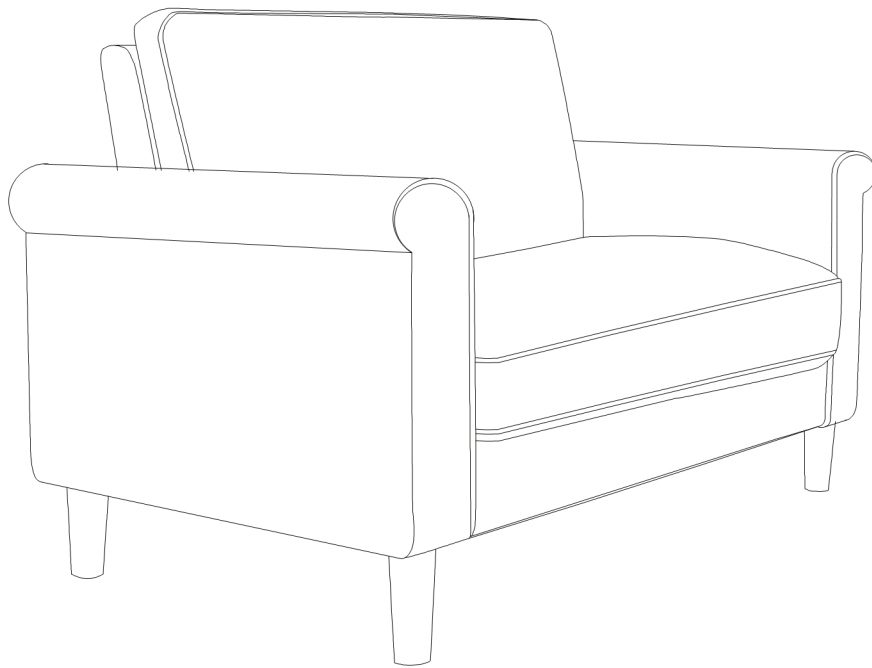

Care instruction on for PU furniture:

In order to maintain the original appearance of your PU furniture, please follow below simple care procedures:

- Avoid exposing furniture directly to sunlight or heating or heating conditioning outlets. Sunlight and or exposure to heating and air conditioning outlets will fade/damage PU.
- Do not place your upholstered furniture too close to windows, radiators, or vents, and be sure to use windows, radiators, or vents.
- Vacuum or wipe with a cloth regularly to remove dust.



For items used on wooden floor, hard surfaces or carpets, it is recommended to install protective pads under all legs and supports to avoid/prevent from damages/scratches and discoloration.