

Drawer Storage Tower

Instruction Manual

CAB-5HBC-48IN



EST 9:00AM--17:00PM



HJ-Customer-Service@outlook.com



(909)637-7665 | (909)637-7593

1 Component List

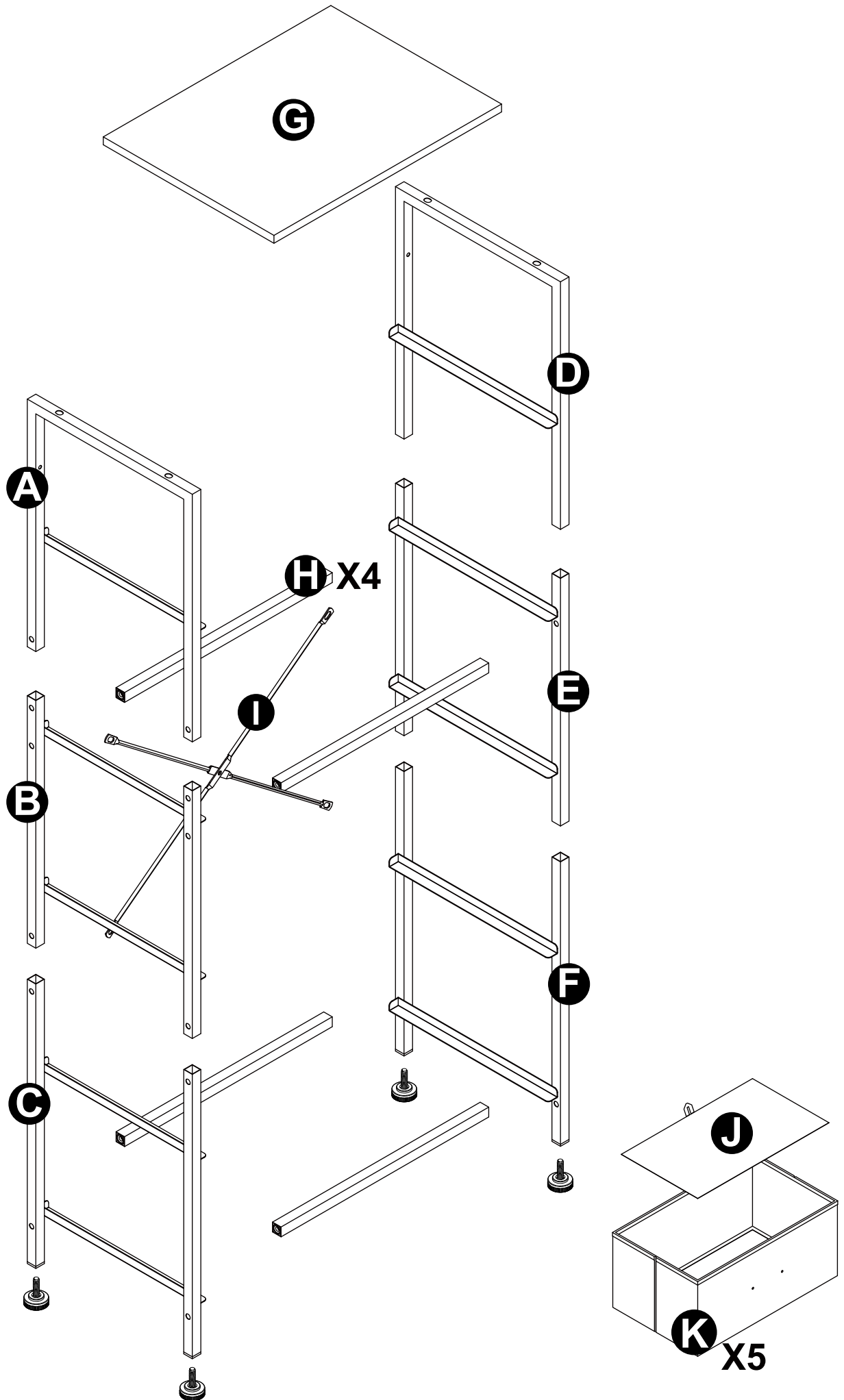

2 Package List

Ax1

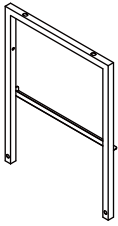

Right Frame

Bx1

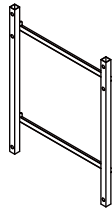

Middle Frame

Cx1

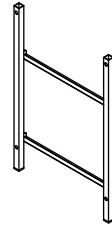

Bottom frame

Dx1

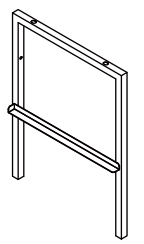

Bottom frame

Ex1

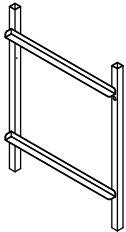

Top Cross

Fx1

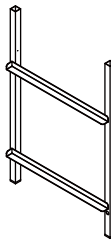

Bottom Cross

Gx1

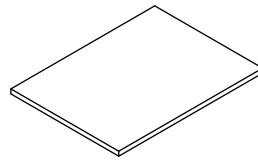

Top Panel

Hx4

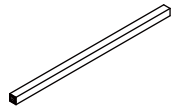

Left Slats

Ix1



Top Broad

Jx5

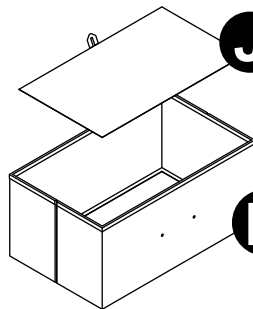

Drawer

Kx5

1x4

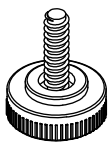

Adjusting Foot

2x12

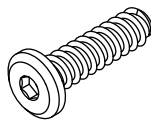

Screws
M6 x 22mm

3x16

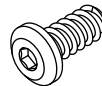

Screws
M6 x 10mm

4x8

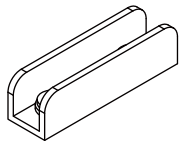

5x1

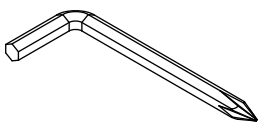

Wrench

6x10

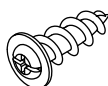

Screws
M4 x 10mm

7x2

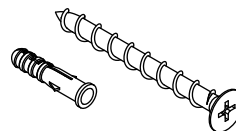

Screws &
Expansion Tubes
M4x60mm

8x5

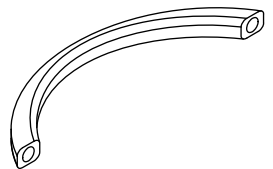

Drawer Handle

Step 1

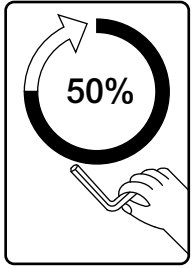

Tighten the screws by 50%

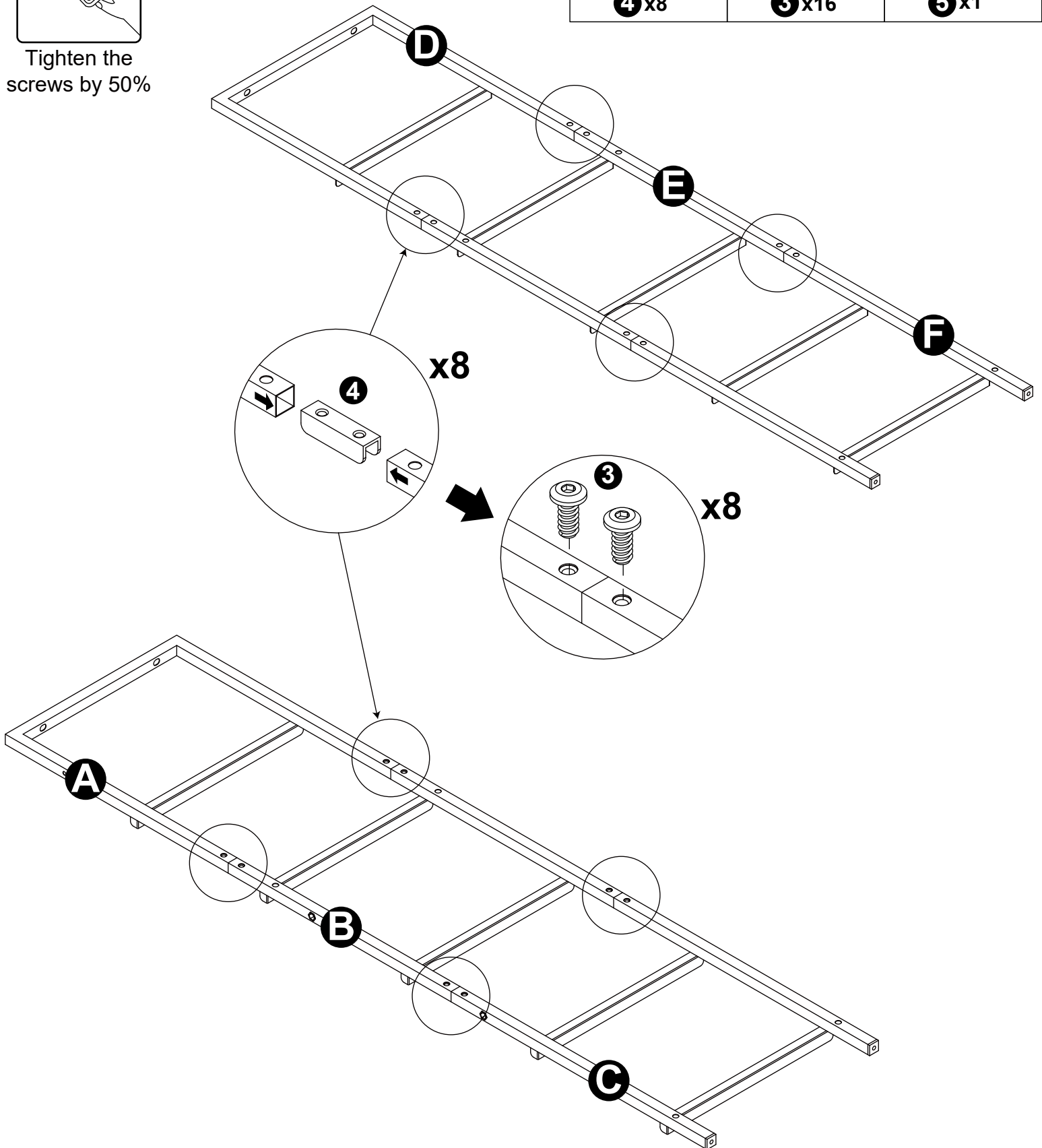
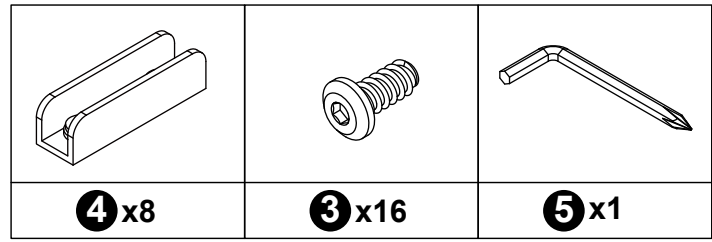

Step 2

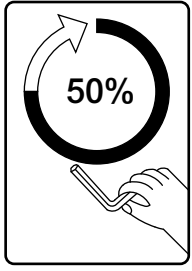

Tighten the screws by 50%

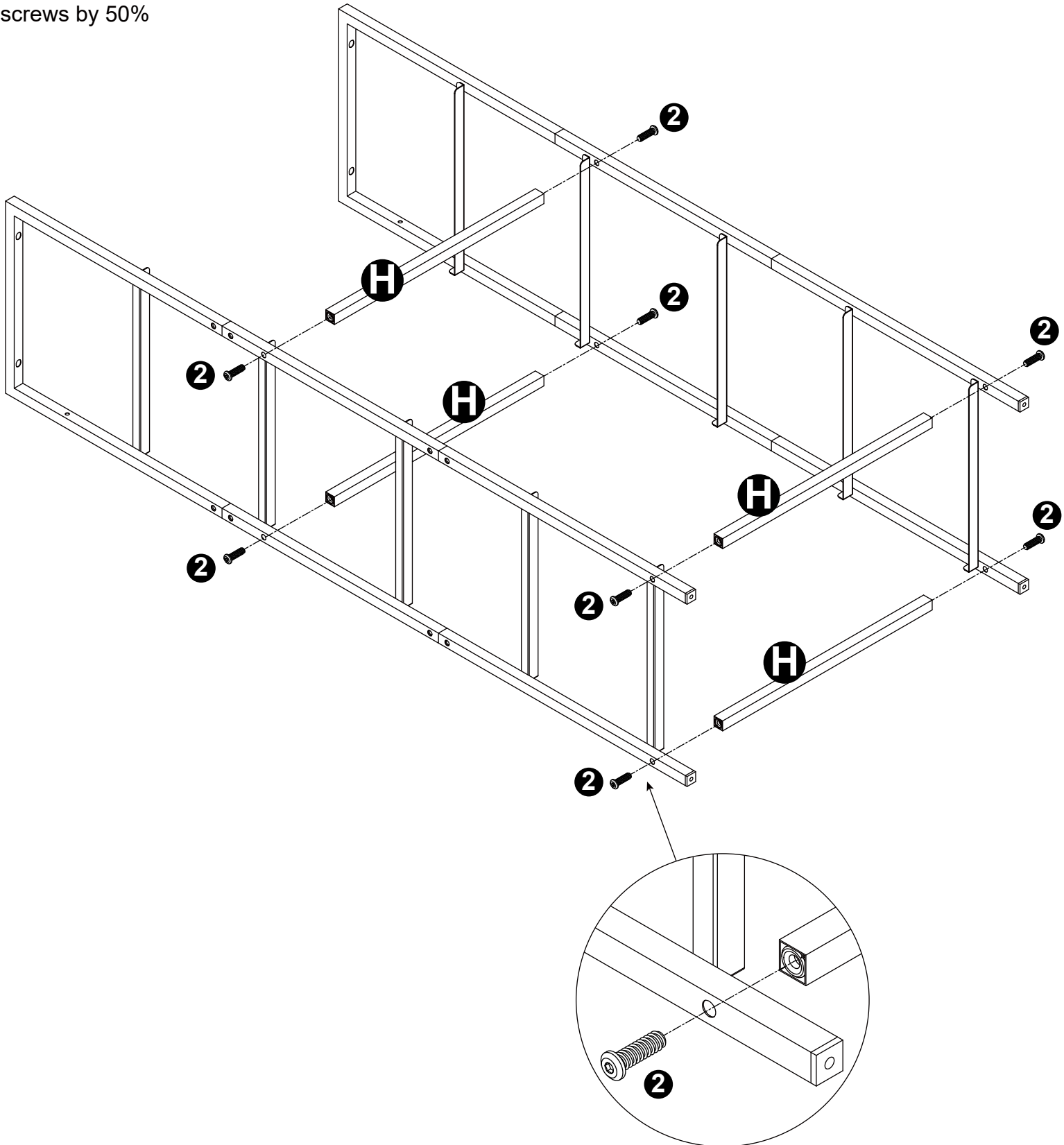
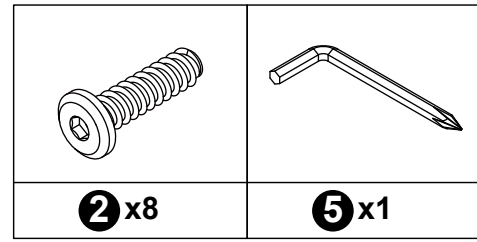

Step 3

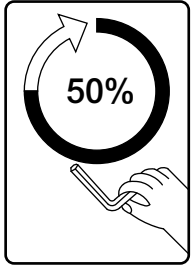

Tighten the screws by 50%

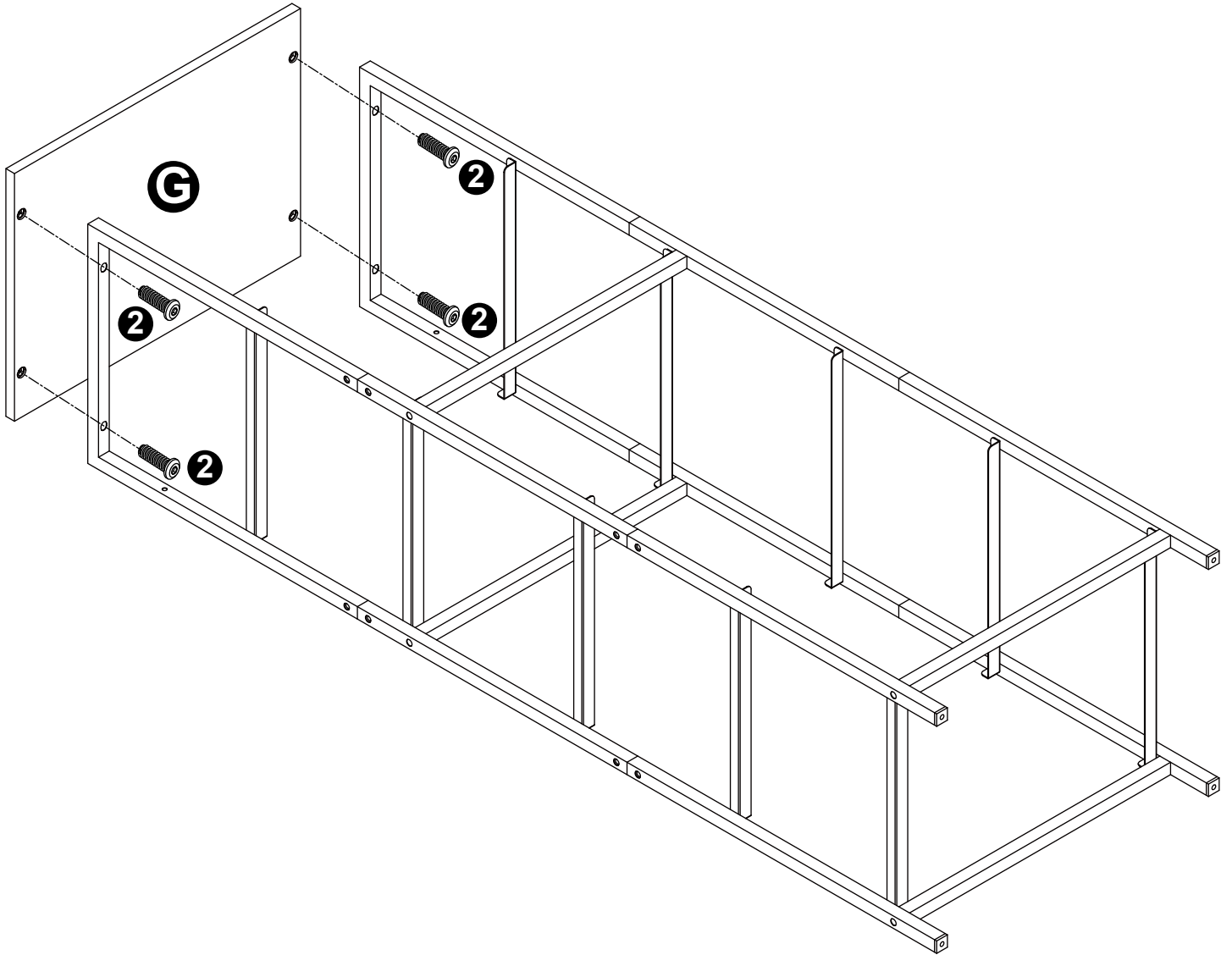
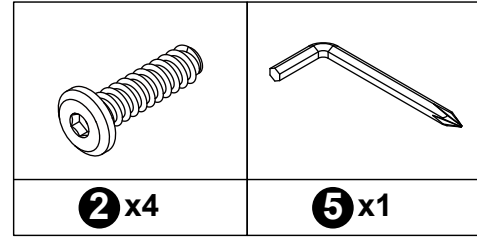

Step 4

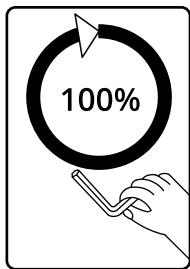

Tighten the screws by 100%

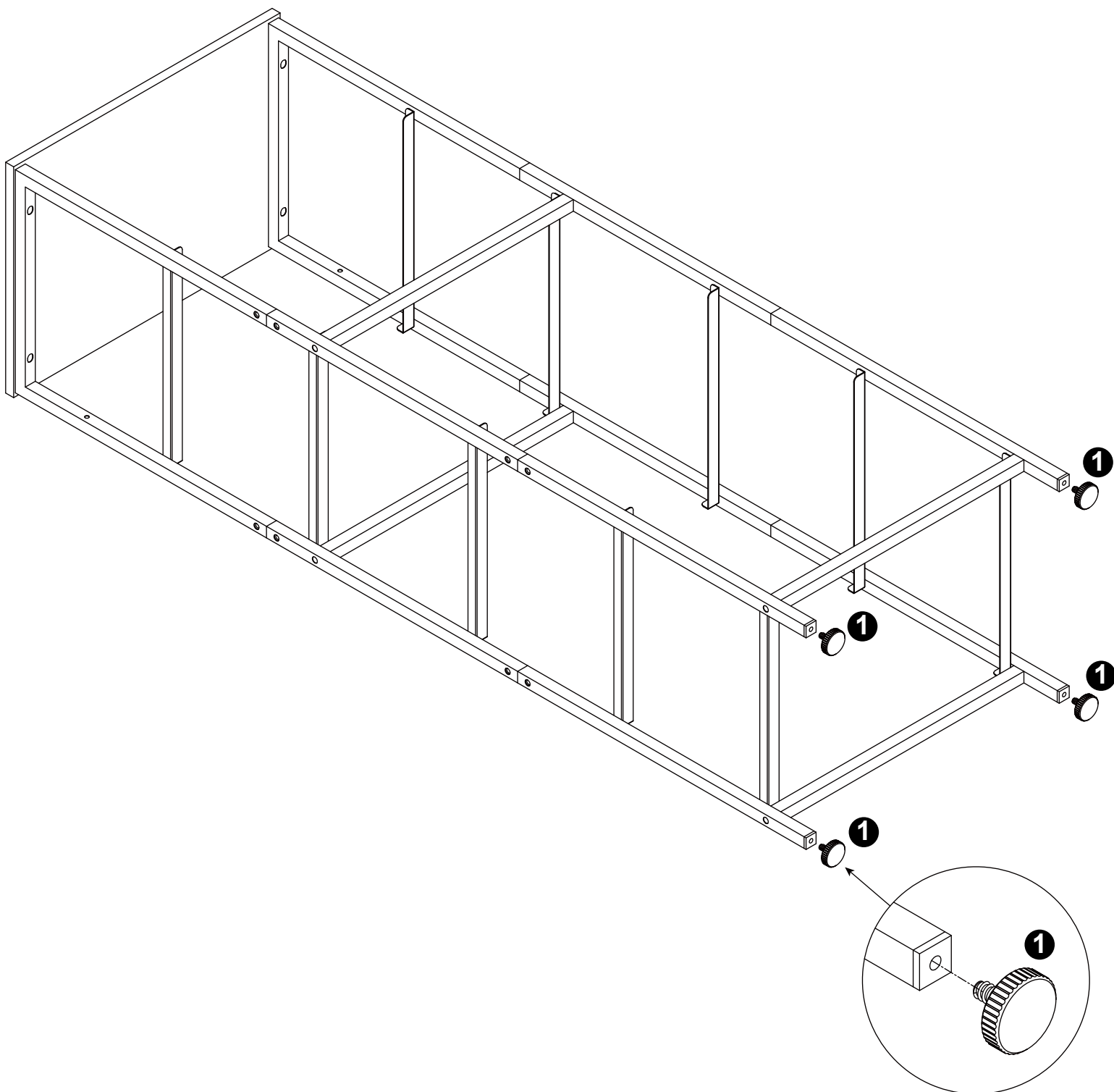
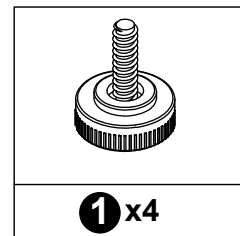

Turn it over.

NOTE: Make sure all Bolts are 100% tightened before use.

Step 5

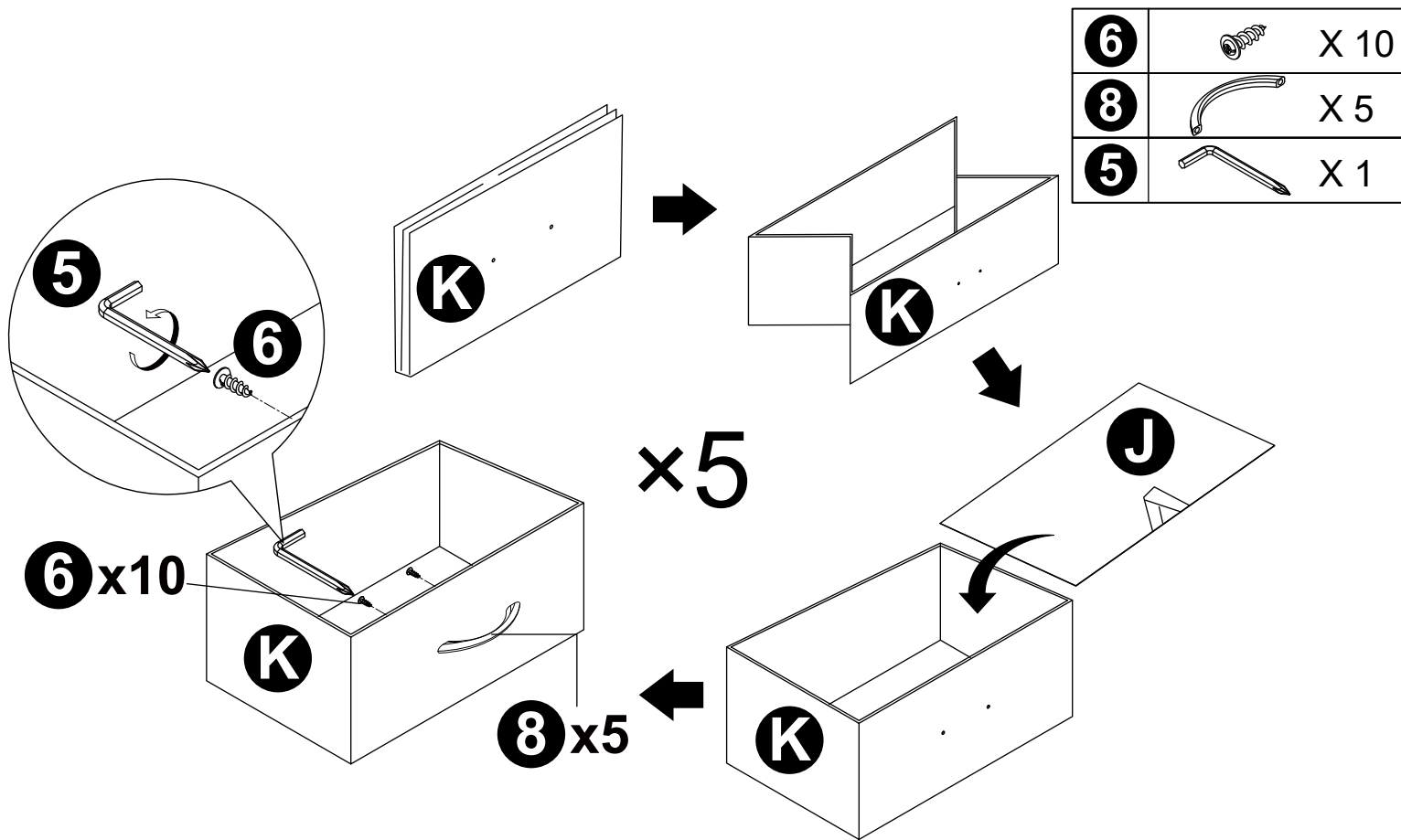

Step 6

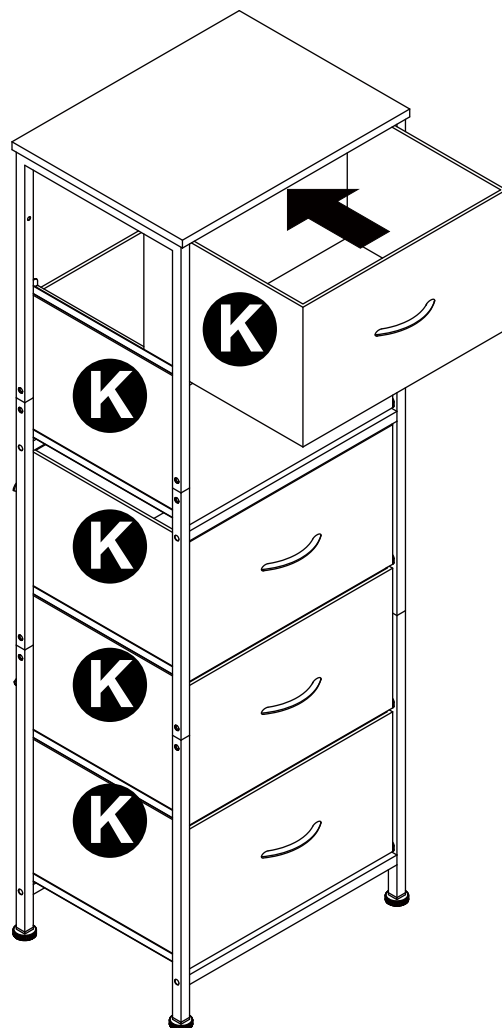

Step 7

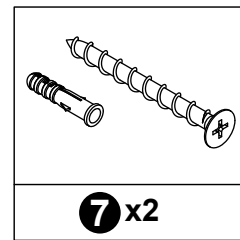
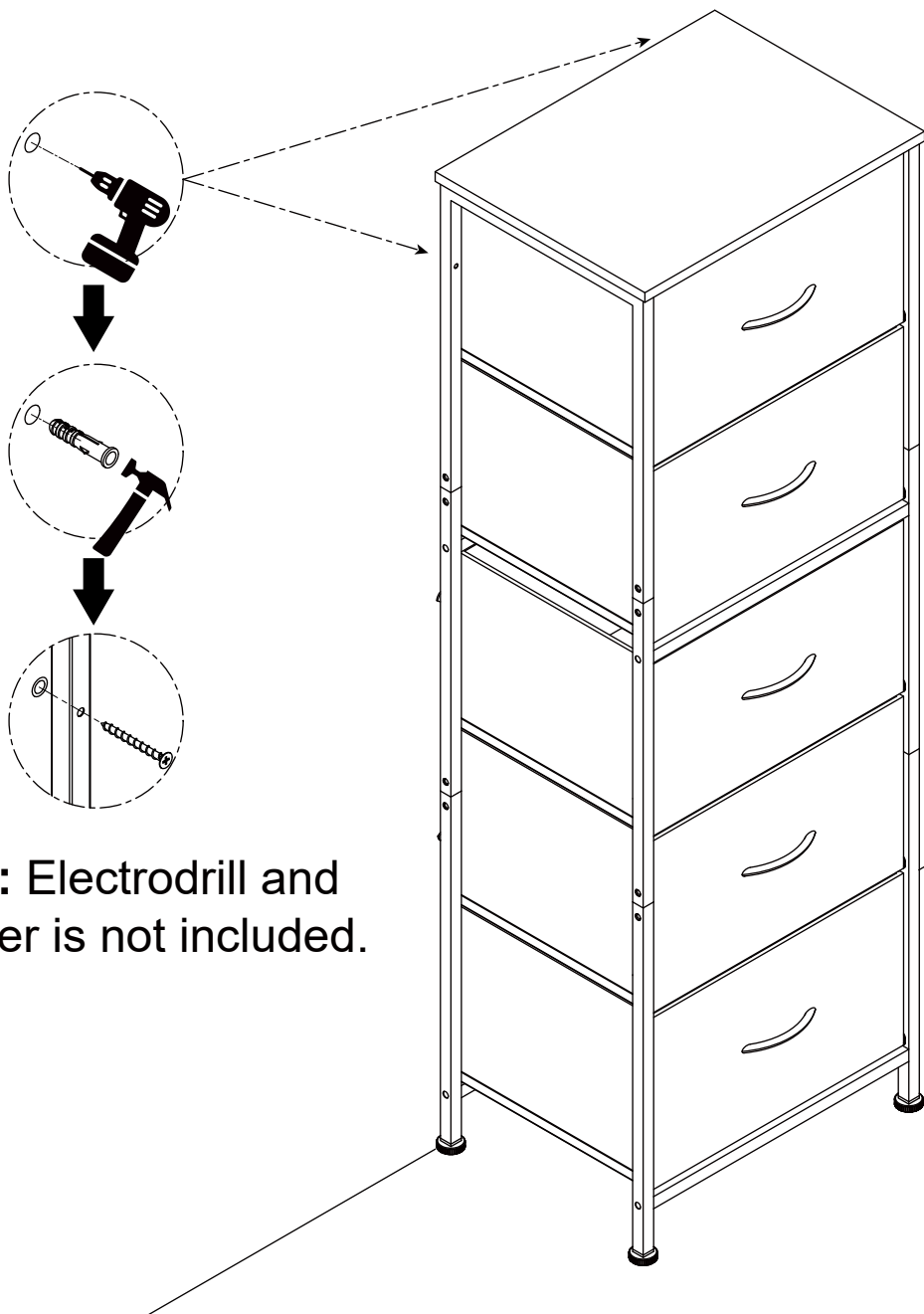

NOTE: Electrodrill and hammer is not included.



Technical Support

(909)637-7665 | (909)637-7593

Other Info

HJ-Customer-Service@outlook.com

Thank you for choosing this product. We strive to provide you with the best quality products and service in the industry. Should you have any issues, please don't hesitate to contact us.