

E-bidet
USER MANUAL

Contents

Safety notes	1	Before use
Use precautions	4	
Product description	5	
Component description	6	

Installation steps	7	Installation and use
Use method	10	

Cleaning and maintenance	12	Other matters
Faults and solutions	14	
Product technical specification	16	

Safety notes

Read the safety instructions carefully before use so as to properly use the product.
Note the following warnings relevant to safety.



Warning



Prohibited



Compulsory



Note

Failure to take cognisance of the above-mentioned warning signs may result in injury or life-threatening risk.

Those who are deficient in body, perception, intellectual capacity, or experience and common sense (including children) are advised not to use this product without supervision. Guidance on the risks and precautions during use of the product by those responsible is highly recommended. Please instruct/ advise children not to play with the instrumentation or buttons and knobs of the product.



Avoid water splashing on the product.

- May result in fire or electric shock.

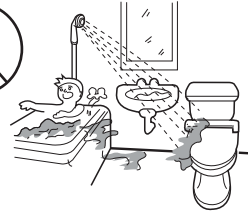

Grounding

Check if the 3-pole grounding structure is proper

- 3-pole grounding structure must be grounded, or otherwise product failure or electricity leakage will occur.



Compulsory

Please observe the following while connecting the power cord:

- If the power cord is damaged, contact the retail store or Jaquar Customer Care.
- Only Jaquar Customer Care personal are authorised to replace the power cord.

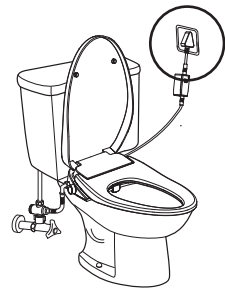

Safety notes

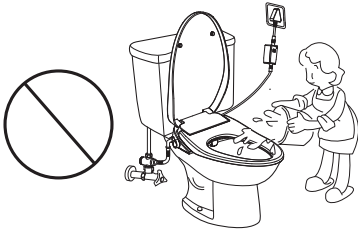

Ensure that the water, cleaning agent or urine does not wet the power plug.

- May result in fire or electric shock.

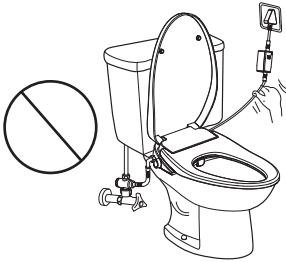

Do not pull the power plug/power cord.

- May result in fire or electric shock.

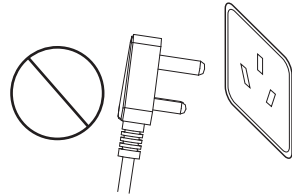

Do not use a loose socket.

- May result in fire or electric shock.

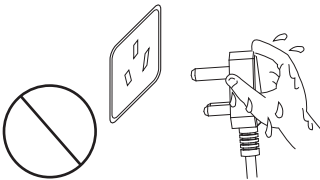

Do not plug/ pull the power plug when hands are wet

- May result in electric shock.

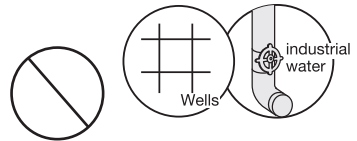

Do not connect to substandard water pipe

- May result in skin infections or product damage.

Safety notes

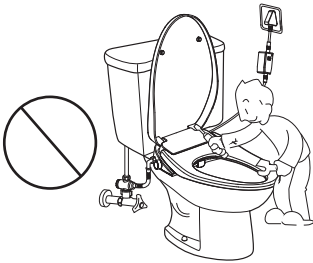

Do not disassemble, repair and modify products without authorization.

- May result in fire or electric shock or electrical/mechanical damages to the product.

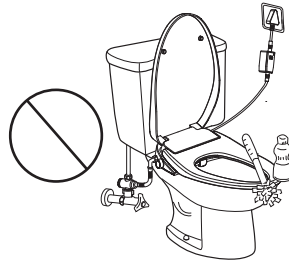

Please unplug the power supply while cleaning the product.

- May result in electric shock.

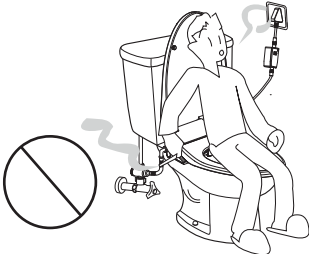

Please don't keep the lit cigarettes or other combustible items near the product

- May result in fire.

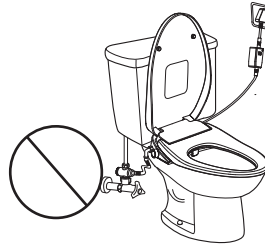

Do not bend or twist the water supply hose.

- May result in water leakage.

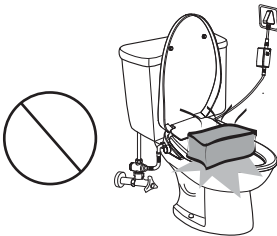

Do not place heavy objects on the toilet seat or the toilet cover

- May result product damage.

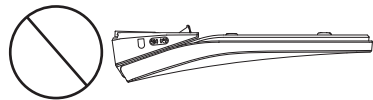

Do not invert the product

- May result in product damage.



To clean your Bidspa, please use only diluted kitchen cleaning agents. Please do not use the following items: Benzene, paint thinner, detergent powder, nylon brush, etc.

- May result in product damage.

Use precautions

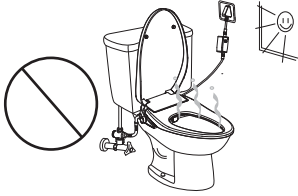

Do not place this product in direct sunlight.

- It may cause product discoloration and failure of seat heating function.

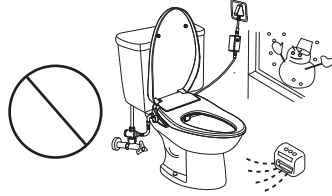

The room temperature of toilet should be above 0°C.

- Otherwise, it is possible for components of the product to freeze/ malfunction. Use warm air and other methods to improve the temperature in the toilet.

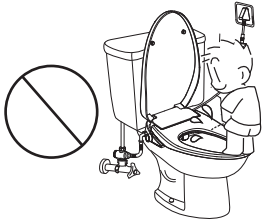

Do not spill/ spray urine on the bidet body and nozzle.

- May result in blockage.

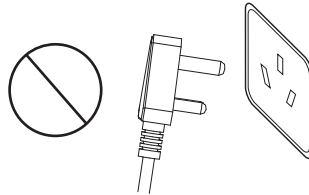

Please not use substandard power supply/ plugs or sockets

- May cause product failure.

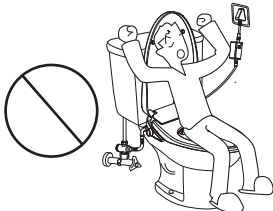

Do not lean against the seat lid

- May cause damage to the seat lid.

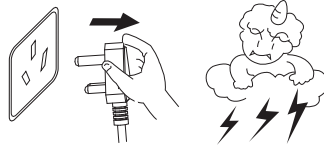

Remove the power plug from the socket when lightning strikes.

- May result in product failure or damage.

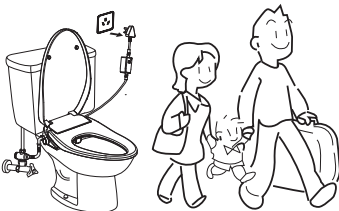

When not in use for a long time, drain the stored water and pull the plug.

- Otherwise, water pollution and skin infections may be caused.

Product description

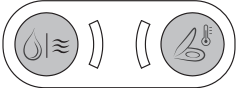
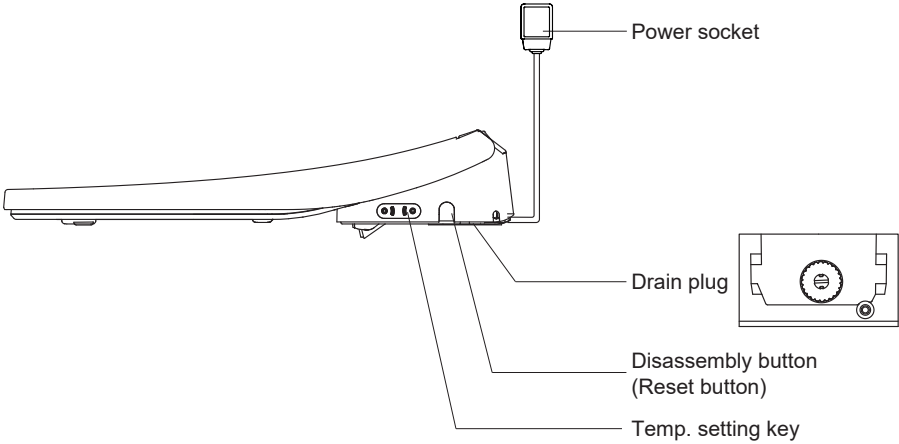
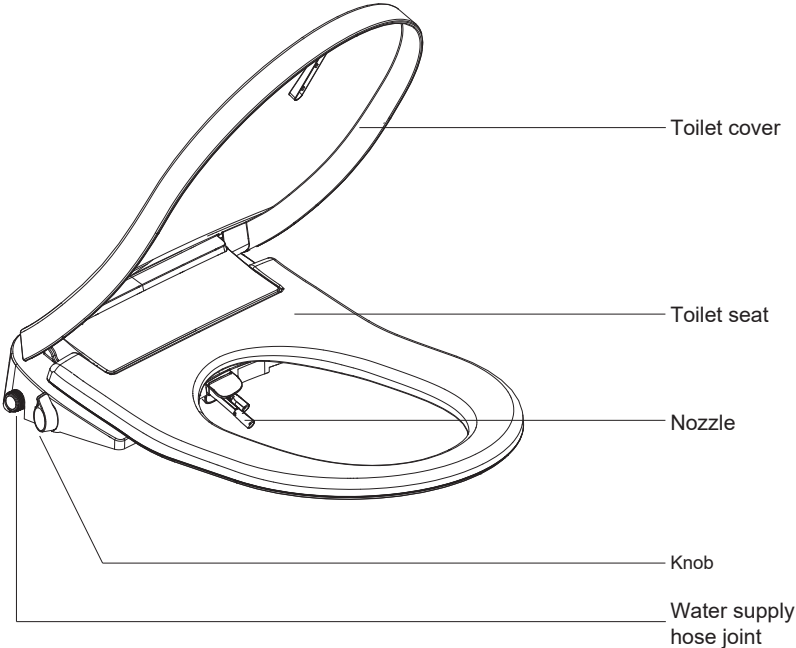

water or wind seat

Components description

1. Cover plate

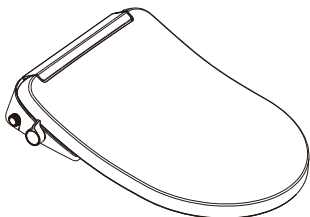

2. Installation template

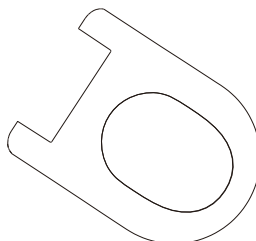

3. Fixation part



Connecting bolt (2)



Plastic TAB(2)

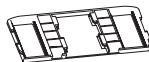

Fixing plate



Rubber bushing(2)



Adjustment sheet (2)

4. T-junction

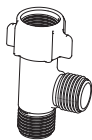

the picture is for indication

5. Water inlet hose



Filter screen

6. User manual

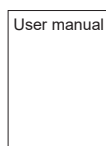

Installation steps

• Installation tools



Cross screwdriver

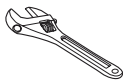

Adjustable Spanner



Barrel and rag

• Installation precautions

1. Water pressure range: 0.1-0.75MPa, please follow the instructions.
2. Corner valves shall be located close to the location where this product is installed and disassembled.
3. Please use the braided hose that comes with the product to prevent water leakage.
4. When installing braided hose, be careful to prevent the black gasket falling out.
5. Please install the check valve filter as shown in the right figure.

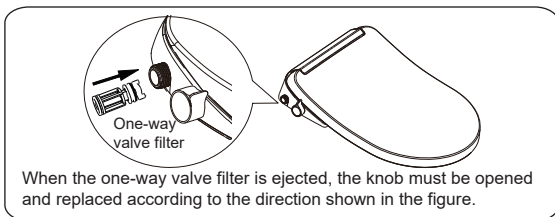

• Installation Procedure

1. Remove the old cover plate by loosening the connecting nuts.



2. Place the mounting template on the ceramic as shown. Align it with the rim of toilet.

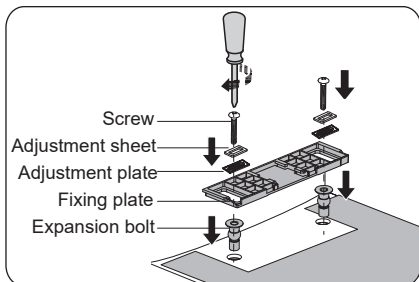
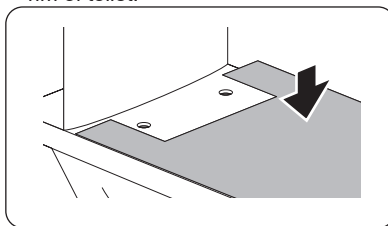

3. ① Insert the expansion bolt into ceramic hole;
② Place fixing plate in notch part of template;
③ Place adjusting sheet and plate in fixing plate;
④ Align expansion bolt hole, and tighten up;

Installation steps

4.To ensure the normal use of the product, please press reset key before installation;

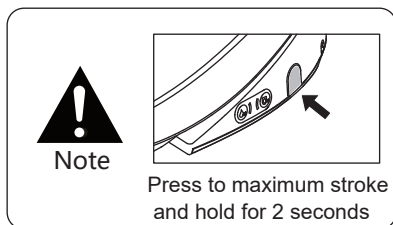

5.Slightly push the cover into fixing plate until you heard "click" , indicating that the cover has been installed in place.

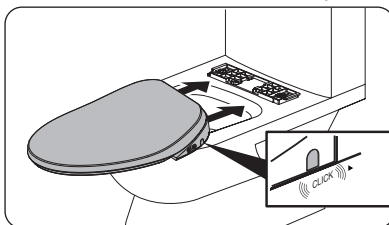

6.Close the water valve;

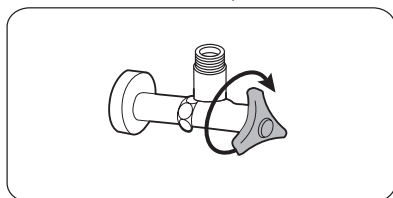

7.Install braided hose ;

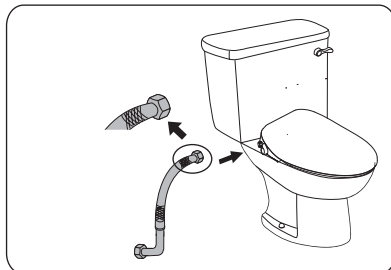
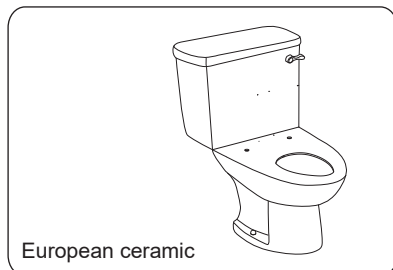

①When the ceramic is similar to the figure above,we suggest connecting the straight end of the hose to the cover

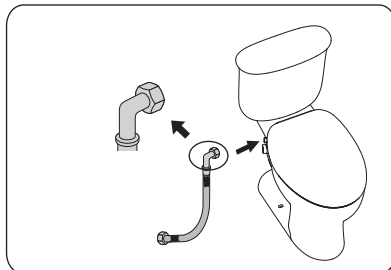
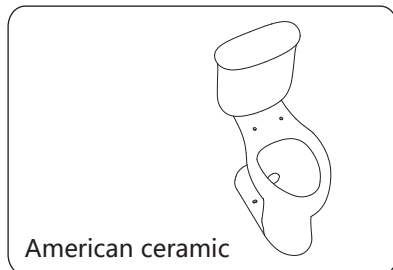

①When the ceramic is similar to the figure above,we suggest connecting the elbow end of the hose to the cover

Installation steps

8.Installation tee;

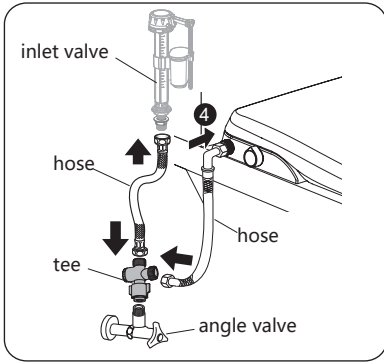

Normally, the tee is installed on the angle valve

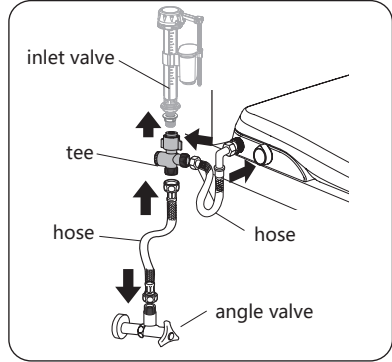

if the angle valve and wall is too close, you can install the tee under the inlet valve

9.Open the angle valve to check for water leakage;

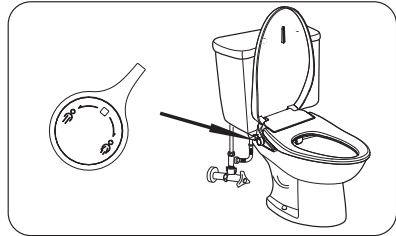
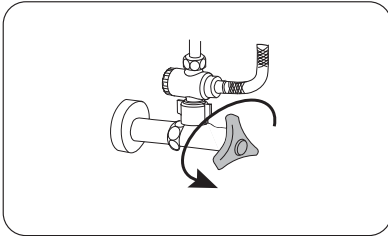

11.Plugged into a power supply;



Note

In order to protect the internal circuit, be sure to turn on the knob to make the nozzle out before plugged into power



Prohibition

1. It is strictly prohibited to move the product from the toilet cover, otherwise easy to cause mechanical failure.
2. It is strictly prohibited to connect hot water above 40 C and cold water that may lead to icing.

Knob Operating Instructions

• Standby mode

1. After the power supply is connected, the “bi” indicates that the cover can be used normally.
2. Water temperature by default at low gear: about 35°C.
3. Seat temperature by default at low gear: about 33°C.

• Rinsing function

1. Bidet/Hip Rinsing

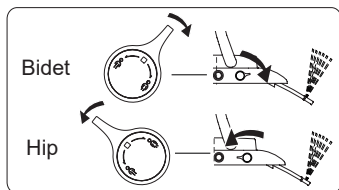

After sitting down, there is a beep prompt, rotating the knob to start rinsing

2. Self-cleaning

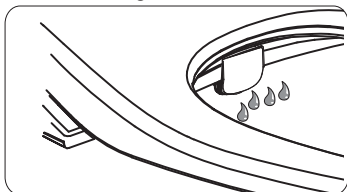

After sitting down, rotating the knob, spray rod self-cleaning, for cleaning nozzle

Attention: close the knob after cleaning!

• Key function

Breath lamp flashes when cleaning

Breathing lamp

Key



1. Lighting Settings

press , you can set the light cycle, and there will be sound prompt when switching

③

Knob light on, toilet light on (default)

①

Knob light on, toilet light off

②

Knob light off, toilet light off

2. Cleaning setting

When cleaning, press  to set the cleaning mode in a cycle

③

Regular cleaning

①

Powerful cleaning

②

Massage cleaning

3. Warm air setting

① After rinsing, press  to open the function of warm air

② Turn off warm air: A. It will automatically close after 4 minutes.

B. It can be automatically closed when you get up.

C. Press  again to close;



The specific functions shall be subject to the actual products

Note

Function Setting

• Description of function

Function setting key

Lighting

Water/wind temp. setting key

Lighting

Seat temp. setting key

TIP

OFF LOW HIGH

- Repeatedly press will switch over water temp. in the sequence indicated in the left figure.
- Change water temp. : a short sound.
Turn off water temp. : a long sound.
- low : about 35°C.
high : about 38°C.

- Repeatedly press will switch over wind temp. in the sequence indicated in the left figure.
- Change wind temp. : a short sound.
Turn off wind temp. : a long sound.
- low : about 33°C mid : about 38°C high: about 43°C.
(The specific temperature is slightly different depending on the ambient temperature)

- Repeatedly press will switch over seat temp. in the sequence indicated in the left figure.
- Change seat temp.: a short sound.
Turn off seat temp.: a long sound.
- low: about 33°C
high: about 37°C.

• Protection functions:

1. Anti-splash function:
when the knob is not completely closed, it will alarm and automatically switch to self-cleaning.
2. Water temperature protection function
 - (1) When the water temperature exceeds 43°C, it will automatically switch to self-cleaning.
 - (2) At this time, it must be reconnected to the power supply to reset product.
3. Low temperature scalding protection function:
After seated by 5min, the seat temp. will automatically switch to Low temp. scalding protection

• Use during power failure

The water temperature and seat temperature cannot be adjusted when the power supply is cut off, but the rinsing with normal temperature can be used.

Cleaning and maintenance

• Manual cleaning of spray tube

- Gently pull out the nozzle and wipe clean with a soft cloth, sponge or a small brush dipped in neutral detergent solution
- Support the nozzle and wipe the spray tube and nozzle dry

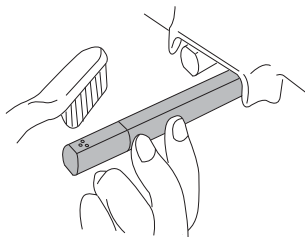

• Clean filter screen

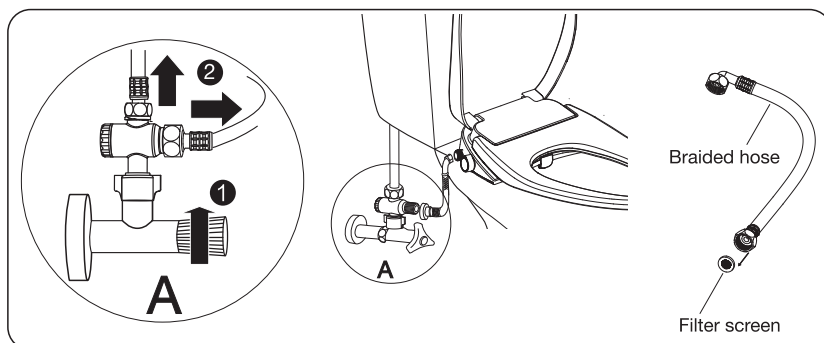

12

i Tips:

- Make sure that the stopcock/angle valve is closed and the power is off before you clean the filter screen;
- Clean the filter screen when the water flow is less.
- During the cleaning process, the product must be properly separated from the water inlet hose;
- Reinstall the filter screen in reverse order after cleaning.

• Product surface cleaning

A Note: Please switch off power supply before cleaning.

- Wipe the product surface with a sponge or soft cloth dampened with room temperature water or a neutral detergent.
- Lift the upper cover and the seat ring when cleaning other parts with cleaning agents.
- Do not install seat cover over ceramic toilet before the cleaning agent is completely washed from ceramic surface.

Cleaning and maintenance

• Leakage protector

Check the leakage protector regularly, at least once a month, using the following method:

- Press leakage protector Reset button. The Indicator light and the power supply is on.
- Press the Test button of the leakage protector. The indicator light will go off and the power supply will be disconnected (in case there is an error).
- When the operation is completed, the corresponding error indication information appears. Stop using the product, contact the local supplier or call the service hotline to replace the leakage protector.
- Please ensure that the leakage protector indicator light is always on when the product is operating.
- If the leakage protector is already installed in the line, check it in the manner described above.

► Schematic diagram of leakage protector:

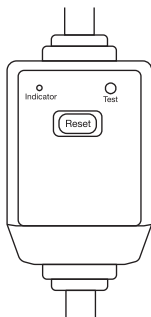

• Product maintenance in winter

Keep the proper water temperature to prevent the water in the toilet and the water pipe from being frozen.

Stop using the product and close the stopcock/angle valve when the ambient temperature is below 0 °C.

• Not in use for long time

When this product is not used for a long time, drain the water in the product and cut off the power supply:

- Pull out the power plug or press the "Test" key of the leakage protector.
- Close the angle valve and stop the water inlet.
- Remove the water inlet hose from the angle valve to the toilet end, and empty the water in the water inlet hose.
- Close the upper cover, press and hold the removal button by hand, move the electronic seat cover from the front, and then complete the removal.
- Place the cover in a cool and dry place when not in use for a long time.

Troubleshooting

• Common fault diagnosis

When you think it is a fault, try some of the following processing methods. If the product is still not working properly, contact your local repair center or call the service hotline.

Check power supply 1.If power supply is under normal state. 2.If leakage protector trips 3.Manual reset thermostat(Installation step4)	Check water supply 1.If water supply is under normal state. 2.If corner valve is closed.
If the following occurs, cut off the power supply immediately.	
The leakage protector trips frequently	

⚠ Note: When water leakage occurs, close the angle valve and cut off the power supply.

• Water leakage analysis

Phenomenon	Possible cause	Solution
When person leaves the seat, the product alarm and water outlet continues to leak	Knob is not close	Close the knob
	Control valve is failed	Cut off the power supply, close the angle valve and contact the after-sales department for replacement.

• Analysis of rising failure

Phenomenon	Possible cause	Solution
There is no water when the knob is turned on	The inlet hose folds, causing blockage	Close the Angle valve and reinstall the inlet hose
After turning on the knob, the spray rod does not extend, but continues to flow	Self-cleaning nozzle before rising	Wait a few seconds
	Didn't seat on interaction area	It is necessary to sit on the interaction area of theseat (there is a drip sound prompt), and then turn on the knob again
	Abnormal water temperature, product over-temperature protection	Pull out the power plug to reset and reconnect the power after 5 seconds,
	Abnormal temperature sensor. Water vapor enters the product during use or cleaning in an environment without dry/wet separation, resulting in temporary short circuit	Please leave the product in a dry environment for 1-2 days, and reconnect the electricity to restore normal use. If the fault is still there, please contact the after-sales service for maintenance or replacement.
After turning on the knob, spray rod does not extend, a lot of water into the toilet	Abnormal pressure, product switch to pressure relief mode	Please close the Angle valve, remove the hose, check whether there is any foreign matter in the filter screen at the inlet of the product, reinstall the hose, open the Angle valve, and then open the knob to the maximum.
Normal water pressure, little cleaning water, cleaning force is weak	There are impurities in the water, use for a period of time, the filter screen blocked	Please clean the filter screen of the hose and the filter screen of the product inlet according to the maintenance instructions
Spray rod can be normally extended to rising but no warm water	The product is not connected to power supply	Plug the product into the power socket and check whether the indicator light of the leaky plug is on
	The water temperature function is turned off	Turn on the water temperature function by pressing the key
	The product over-temperature protector is disconnected, so reset operation is needed	Press the product disassembly button to the deepest place and hold it for two seconds (installation step 4)

Troubleshooting, product dimensions



• Failure analysis of seat

Phenomenon	Possible cause	Solution
The seat is cold	The seat heating is turned off	Turn on the heating function in advance
Temperature drops When rinsing	The product started the low temperature scald prevention function	After cleaning, the setting temperature will rise again

• Failure analysis of light

Phenomenon	Possible cause	Solution
Night light is not ON.	Night light is turned off or damaged	Reconnect to the power supply,if the fault still exists contact the after-sales department for replacement
Knob light is not ON	Knob light is turned off or damaged	

• Failure analysis of warm wind

Phenomenon	Possible cause	Solution
Press  without response	Didn't seat on interaction area	Open the function of warm air after sitting
	Can't use warm air during rinsing	Press  after you stop cleaning
	Fan fault	Unplug the power and close the valve, please contact the after-sales service for maintenance or replacement.
no warm wind	Over temperature protection	Unplug the power plug, 5 minutes apart, reconnect to the power supply, if the failure is still the same, please unplug the power supply, close the Angle valve, contact the after-sales service

• Product dimensions drawing

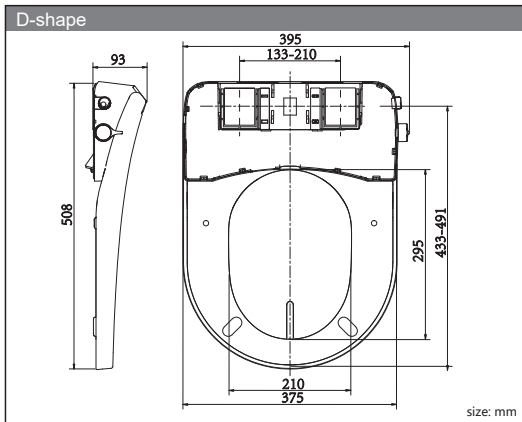

Product technical specification

Items		Description
Rated voltage		220-240V~, 50Hz
Rated power		1050W
Max. transient power		1450W
Length of power line		About 1.5m
Water supply pressure		0.1 ~ 0.75MPa(Static pressure)
Water supply temperature		5 ~ 35°C
Ambient temperature		0 ~ 40°C
Water proof grade		IPX4
Cleaning device	Water amount regulation	Stepless regulation
	Water temperature regulation	Gear 3: about 35/38°C/OFF
	Heating method	Instant heating
	Protective device	Anti-siphon valve + anti-backflow valve
	Safety device	Double thermostat
Warm seat	Surface temperature	Gear 3: about 33/37°C/OFF
	Heater power	50W
	Safety device	thermostat & fuse
Warm wind	wind temperature	Gear 3: about 33-43°C (The specific temp. is slightly different depending on the ambient temp.)
	Heating wire power	180W
	Safety device	Thermostat + fuse
Others	Massage rinse	YES
	Antibacterial material	Nozzle and seat
	Low temperature scalding protection	YES
	Abnormality prompt	Alarm sound
	Control operation	Knob
	Auxiliary key	Water temperature and seat temperature setting
	Seat sense	YES
	Light control	YES

Rated power:

Under the ambient temp. of 23±2°C and the inlet water temp. of 15±1°C, the product starts to power up and start up, and the water temp. and setting temp. are adjusted to top grade. Turn on the hip wash function for testing (the reference flow rate is about 600ml/min). The measured product works continuously and stably Average power of cleaning cycle (3 minutes)

Warranty Card

To dear customers:

Thank you for choosing our E-bidet! If any problem occurs during use, please simply remove and check the problems pursuant to the user's manual. When you cannot remove such problems, contact your local supplier or call the service hotline.

I. Information:

Customer information	Customer name		
	Address		
	TEL		
Dealer information	Name		
	TEL		
Model		Product series number	
Purchase date	Y M D	Warranty period	Two-year free warranty since the purchase date

II. Notes to warranty card:

1. Please complete the warranty card.
2. Warranty cards and invoices are important for the warranty service.
If the product failure occurs during warranty period, please show the warranty card and the invoice when the dealer or after-sales service personnel of the Company provide on-site maintenance and repair.
3. The warranty card cannot be reissued, please keep it properly.

III. Rules on free maintenance

During the warranty period, the Company will provide repair free of charge according to the use instructions, precautions for normal use.

IV. Paid maintenance is required in the following circumstances that do not fall within the scope of free maintenance:

1. Out of warranty.
2. The valid invoice and warranty card cannot be provided during the warranty period.
3. Failure or damage caused by transportation, collision after purchase.
4. Product damage during abnormal use, failure and damage during the warranty period caused by human factors or natural disasters, such as fire, earthquake, flood, lightning or environmental pollution, etc.
5. Failure or damage caused by unauthorized disassembly, modification or maintenance due to user's cause or responsibility.
6. Failure or damage caused by violation of maintenance regulations in use, such as improper use of cleaning agent or wiping and maintenance methods not compliant with maintenance requirements.
7. The consumable items (such as sealing rings, etc.) or products have failed or damaged due to sand and impurities.
8. Conduct the secondary transfer according to the customer's requirements.



