

ASSEMBLY INSTRUCTIONS

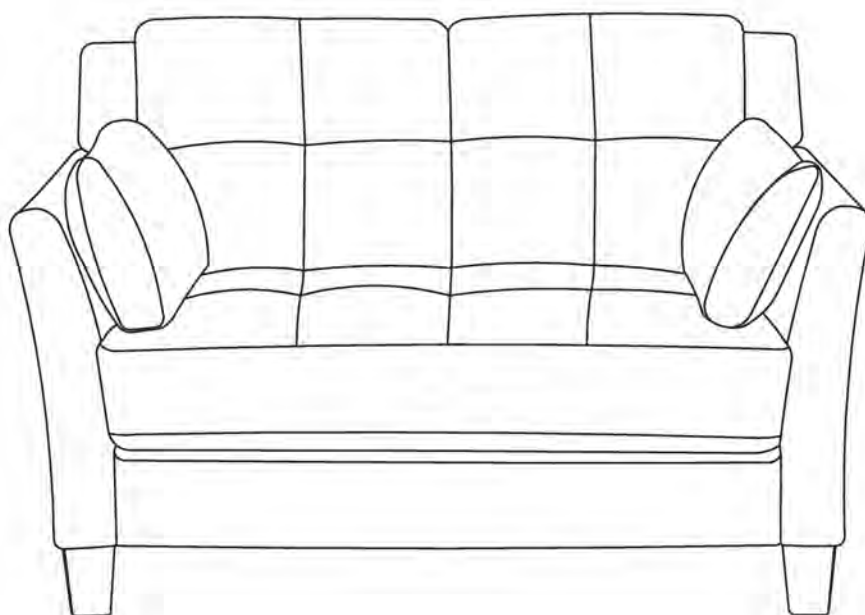

TOOLS REQUIRED



Wrench
(Included)



2 - People
Recommended

ASSEMBLY RATING



EASY —————> DIFFICULT

The Assembly Rating is a 5-point system showing the level of effort needed to assemble a specific product.



CHECK BEFORE STARTING

Are you missing anything?

Double-check all parts, hardware and accessories listed on Page 6 are accounted for.

Check out our Quick Tips!

We recommend reviewing the pre-assembly handouts. Even experts need a refresher now and then!

Should we send any replacements?

Are there any irregularities or flaws in the parts? We can send replacements!

Prep Time!

Please review the assembly instructions and all diagrams prior to assembling. Arrange parts as recommended on Page 7 and group identical hardware together to make assembling easier.

PRE ASSEMBLY INTRODUCTION

We understand building ready-to-assemble furniture can be a challenging experience for some. To help avoid confusion, we have provided some helpful tips that may speed up the process.

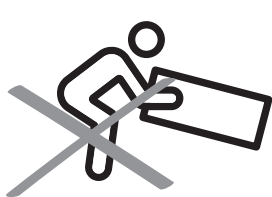

Teamwork

ALWAYS have at least two people to help with transporting and assembling the product to avoid potential injury and/or damage.

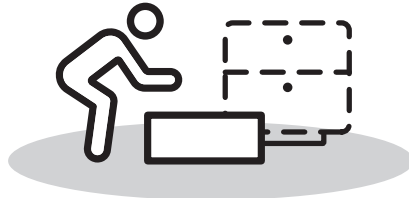
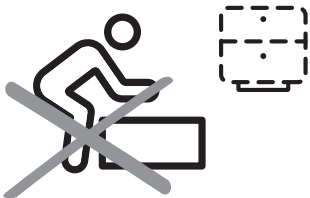

Suitable Location

Assembling near the area of the intended location is highly recommended.



Sufficient Space

Make sure you have enough space to move around during the assembly.

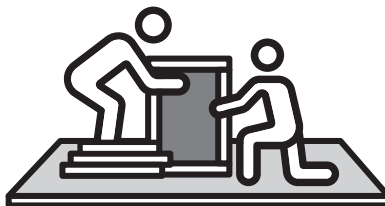

Avoid Scratches

Use cardboard, blankets or a carpeted area while assembling furniture to prevent scratches.

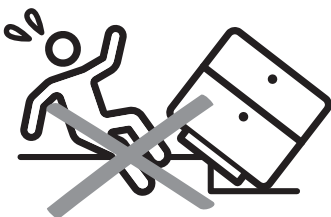

Flat Surface

Make sure the furniture rests on a flat and level surface with each leg evenly touching the floor.

ASSEMBLY AND CARE ADVICE



FAILURE TO FOLLOW THE GUIDELINES BELOW MAY RESULT IN INJURY AND/OR PROPERTY DAMAGE.



Position each part correctly and insert screws or bolts into their respective holes.



Turn clockwise to tighten and only tighten when step is completed or when instructed to do so.



Use the appropriate hand tools or power tools for assembly. Select steps, such as tightening screws and/or bolts, may require hand tools to avoid causing damage during assembly.



Save the instructions and store any supplied tools for later maintenance.



After two weeks, check and tighten any loose hardware and repeat again every six months thereafter.

IT IS THE USER'S RESPONSIBILITY TO MAINTAIN THE FURNITURE. THE HARDWARE MAY LOOSEN OVER TIME AND MAY CAUSE THE FURNITURE TO BE WOBBLY AND UNABLE TO SUPPORT ITS INTENDED WEIGHT CAPACITY. THIS MAY LEAD TO COLLAPSE AND MAY CAUSE SERIOUS INJURY.

LOVESEAT



- Please keep instructions for future reference.
- Check the quantity and irregularity of parts and hardware before you start.

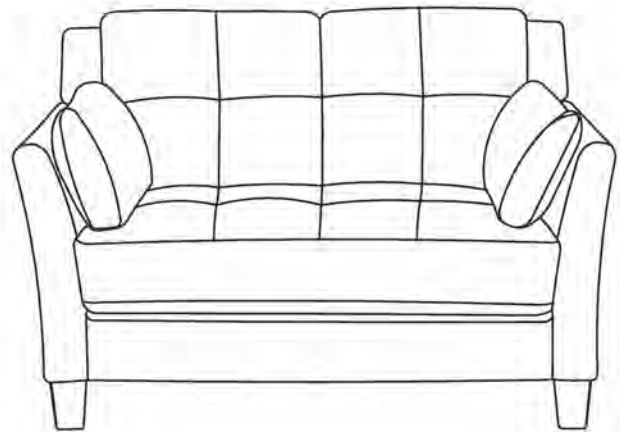

PARTS

#1 1pc

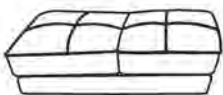

Seat

#2 1pc

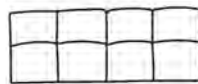

Backrest

#3 2pcs



Arm (L&R)

#4 2pcs



Ear

#5 2pcs



Pillow (L&R)

#6 4pcs



Leg

HARDWARE

#A 14pcs



Threaded rod (M8*95mm)

#B 1pc

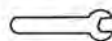

Wrench

#C 14pcs



Hex Nut

#D 14pcs











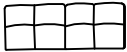

Flat washer

#E 4pcs

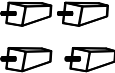

Gasket

CM6717-LV is packed in 2 cases

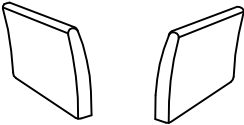
Carton	Disignation		Part	Hardware
CM6717-LV-1	Seat	#1		 #A x14pcs
	Backrest	#2		 #B x1pc
	Ear	#4		 #C x14pcs
	Pillow	#5		 #D x14pcs
	Leg	#6		 #E x4pcs
CM6717-2	Arm	#3		

ASSEMBLY INSTRUCTIONS

1

Part (#2) x1pc

Part (#4) x2pcs

Hardware (#A) x4pcs

Hardware (#C) x4pcs

Hardware (#D) x4pcs

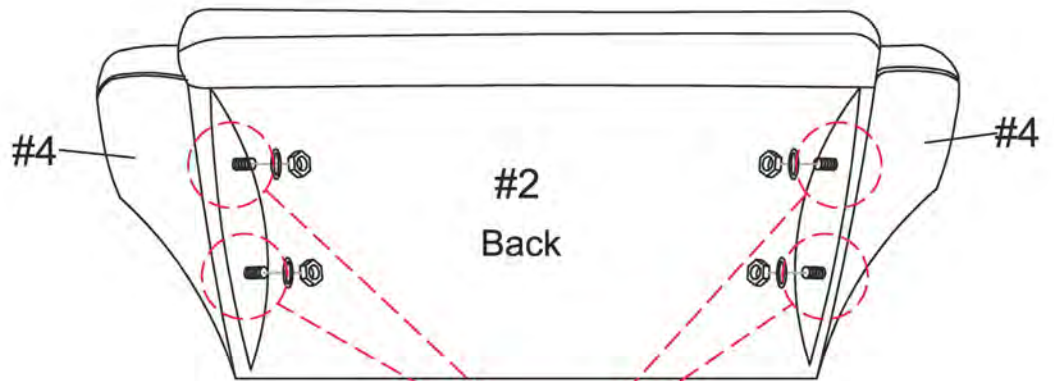

- I. Insert 2 bolts (#A) into each ear (#4), turn right to tighten.
- II. Facing the back, align the ears (#4) to the pre-drilled holes along the sides of the backrest (#2). Insert the ends of the bolts (#A).
- III. Onto each bolt end insert a flat washer (#D) and then a hex nut (#C). Secure each by using the wrench (#B).

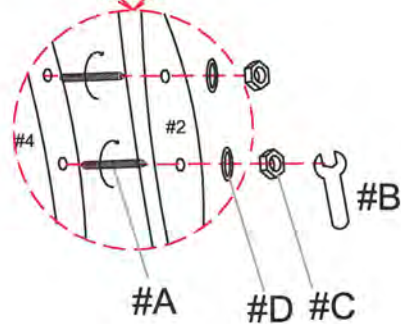

2

Part (#1) x1pc

Hardware (#A) x2pcs

Hardware (#C) x2pcs

Hardware (#D) x2pcs

- I. Insert 2 bolts (#A) into the bottom of the backrest (#2), turn right to tighten.
- II. Facing the back, align the backrest (#2) to the pre-drilled holes along the top of the seat (#1). Insert the ends of the bolts (#A).
- III. Onto each bolt end insert a flat washer (#D) and then a hex nut (#C). Secure each from below by using the wrench (#B).

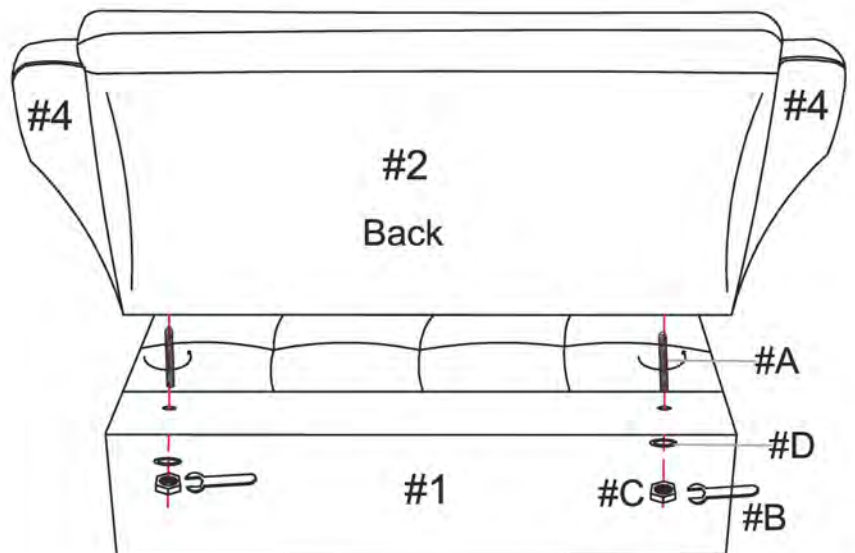

ASSEMBLY INSTRUCTIONS

3

Part (#3) x2pcs

Hardware (#A) x8pcs

Hardware (#C) x6pcs

Hardware (#D) x6pcs

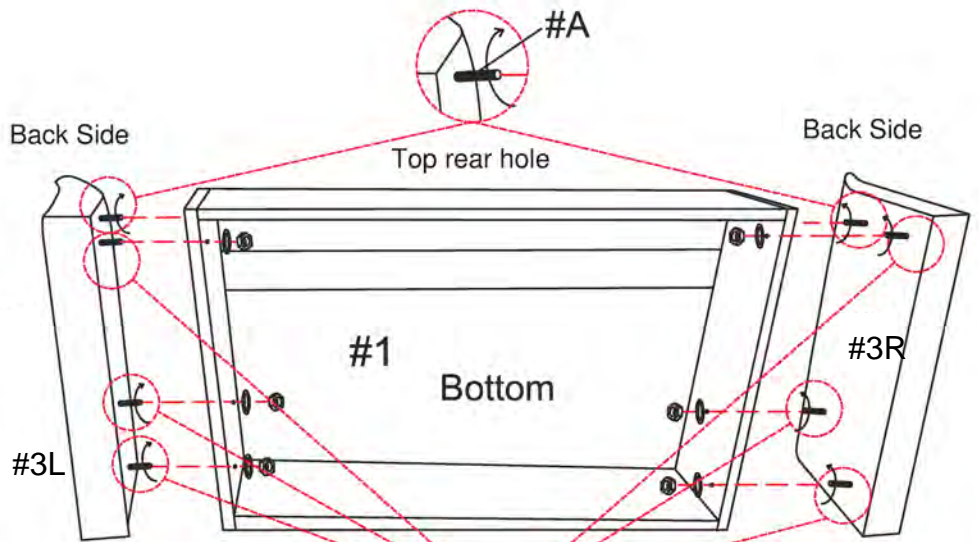

- I. Insert 1 bolt (#A) into the pre-drilled hole on the top back of each arm (#3). Insert 3 bolts (#A) into the remaining holes on each arm (#3), turn right to tighten.
- II. Insert the other ends of the bolts on the arms (#3) into the pre-drilled holes along the sides of the seat (#1).
- III. From within the seat (#1) apply a flat washer (#D) and then a hex nut (#C). Secure each by using the wrench (#B).

4

Hardware (#C) x2pcs

Hardware (#D) x2pcs

Apply the top assembly onto the seat (#1) and insert onto the bolts (#A) on each side. Once inserted, apply a flat washer (#D) then a hex nut (#C) and secure using the wrench (#B).

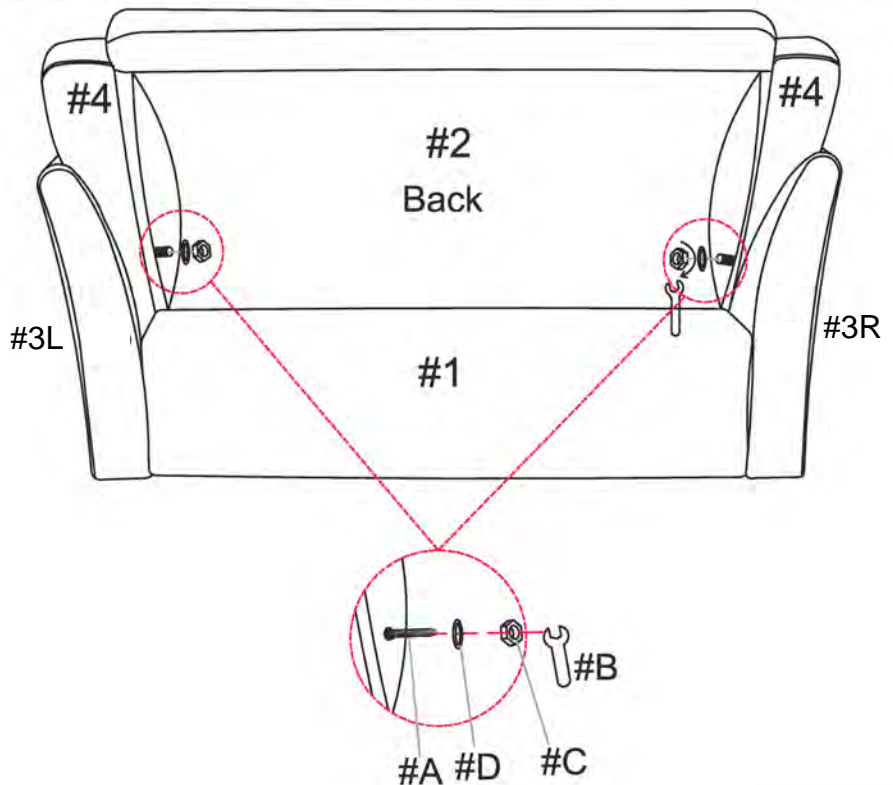

ASSEMBLY INSTRUCTIONS

5

Part #6 x4pcs

Hardware #E x4pcs

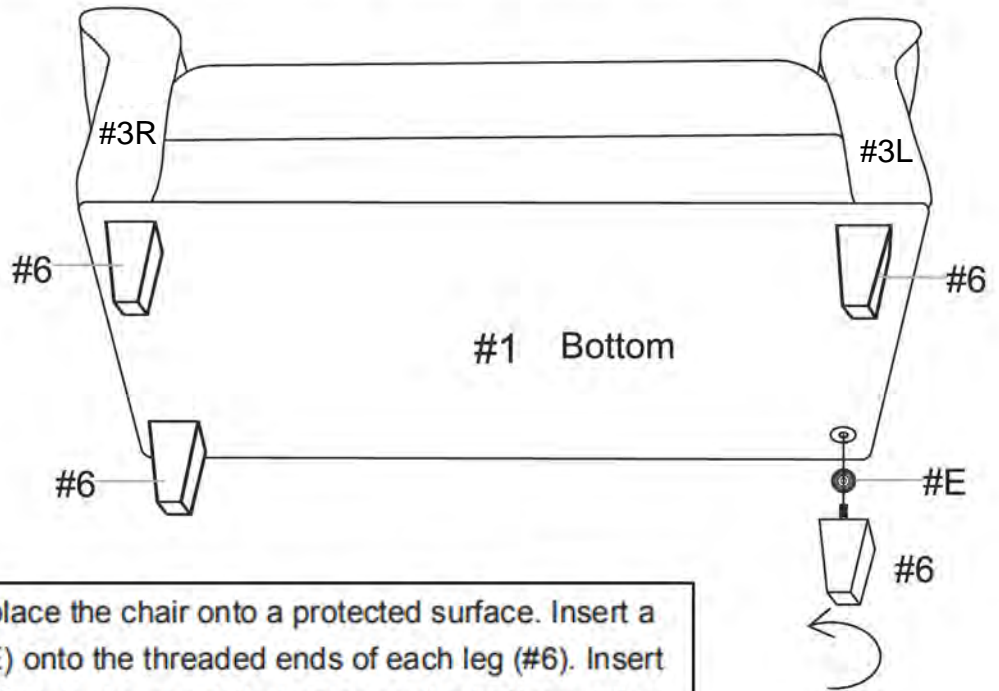

Carefully place the chair onto a protected surface. Insert a gasket (#E) onto the threaded ends of each leg (#6). Insert the legs (#6) into the pre-drilled holes on the bottom of the seat and turn right to tighten.

6

Place pillows. Make sure all parts are firmly secured.

Part #5 x2pcs

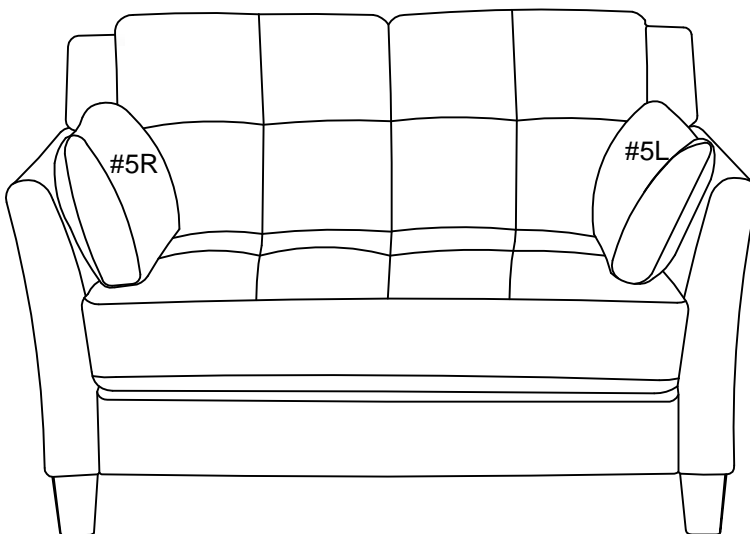

ASSEMBLY COMPLETED



Please ensure the furniture rests on an even and flat surface. If the product wobbles or feels loose, double-check all bolts and/or screws are properly tightened and secured.

✓ Keep this handy!

Please retain this instruction manual and any order-related information for future reference.

✓ Lift, don't drag!

To avoid damage to product please always LIFT the product when transporting or adjusting the placement.