

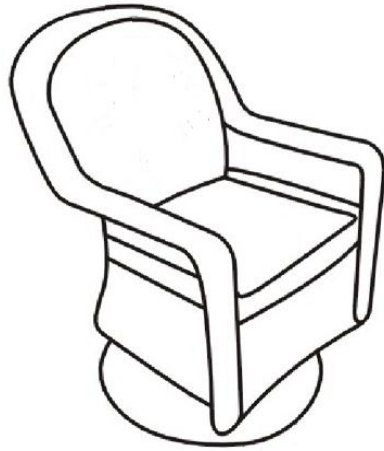



# Assembly Instructions

Caution: You must read this before you proceed

## Swivel Chair





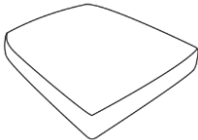

### Part List

Label	Picture	Description	QTY
A		Seat	1
B		Base	1
C		Swivel Plate	1
D		Back Cushion	1
E		Seat Cushion	1

### Hardware

Label	Picture	Description	QTY
①		Bolt (M6*40mm)	9

②		Nut	9
③		Bolt (M6X15mm)	5
④		Washer	22
⑤		Allen Key	1
⑥		Wrench	1

## Assembly Preparation

Before Beginning Assembly:

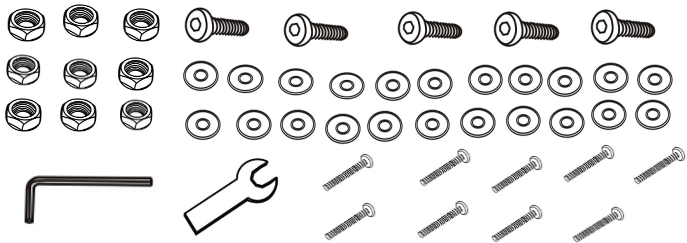

- Read instructions, cover to cover-



- Have 2 adults on hand for assembly-



- Do not assemble on flooring or carpet-



- Assemble on a clean non-marring surface (packing foam)-



- Save all packaging until finished-

## Assembly Steps

### Overview

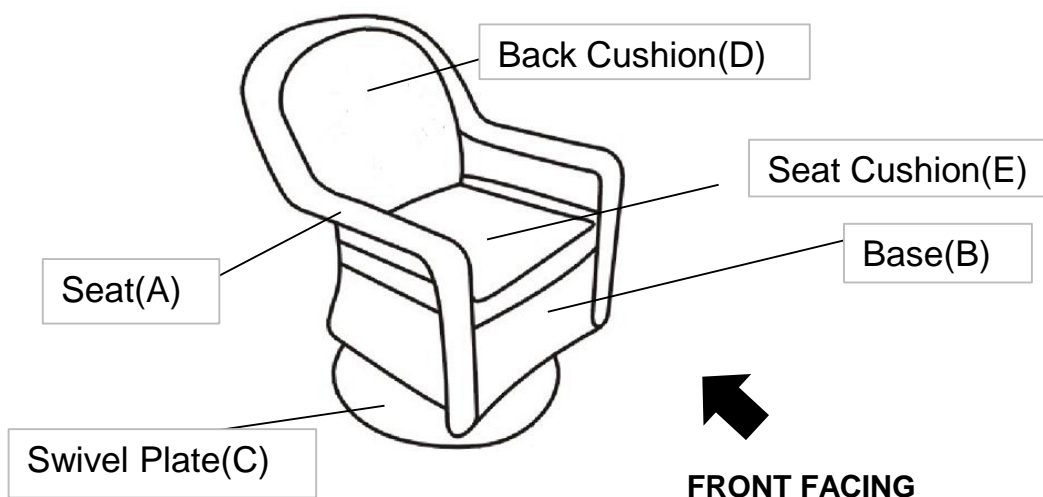

This Swivel Chair has multiple parts and may require up to 30 minutes to assemble. To give you an overview of the Swivel Chair parts, the above picture is to help you put the various parts into perspective. Please read through the instructions below to familiarise yourself with the parts and steps before assembly.

## Step 1

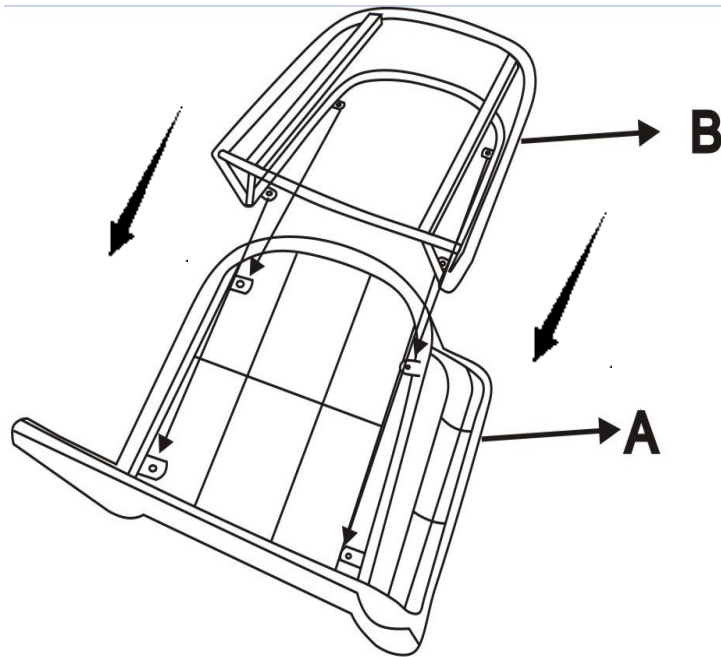

Open the carton and place all the parts onto a clean and soft surface.

Place the Seat(A) with its inside facing skywards.

Insert the Base(B) into Seat(A) and align the mounting positions of the Seat(A) as show picture.

**Note: Occasionally some of the PE wicker covers the mounting positions preventing easy assembly, the PE wicker should not be cut but only moved away from the mounting positions.**

## Step 2

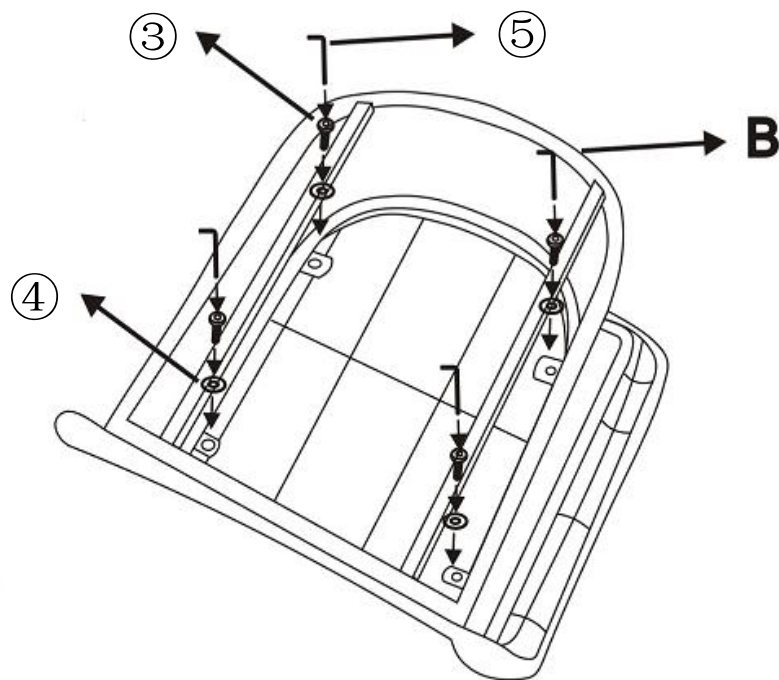

Attach Base(B) and Seat(A) using Bolts(③) and Washers(④) with Allen Key(⑤).

### Step 3

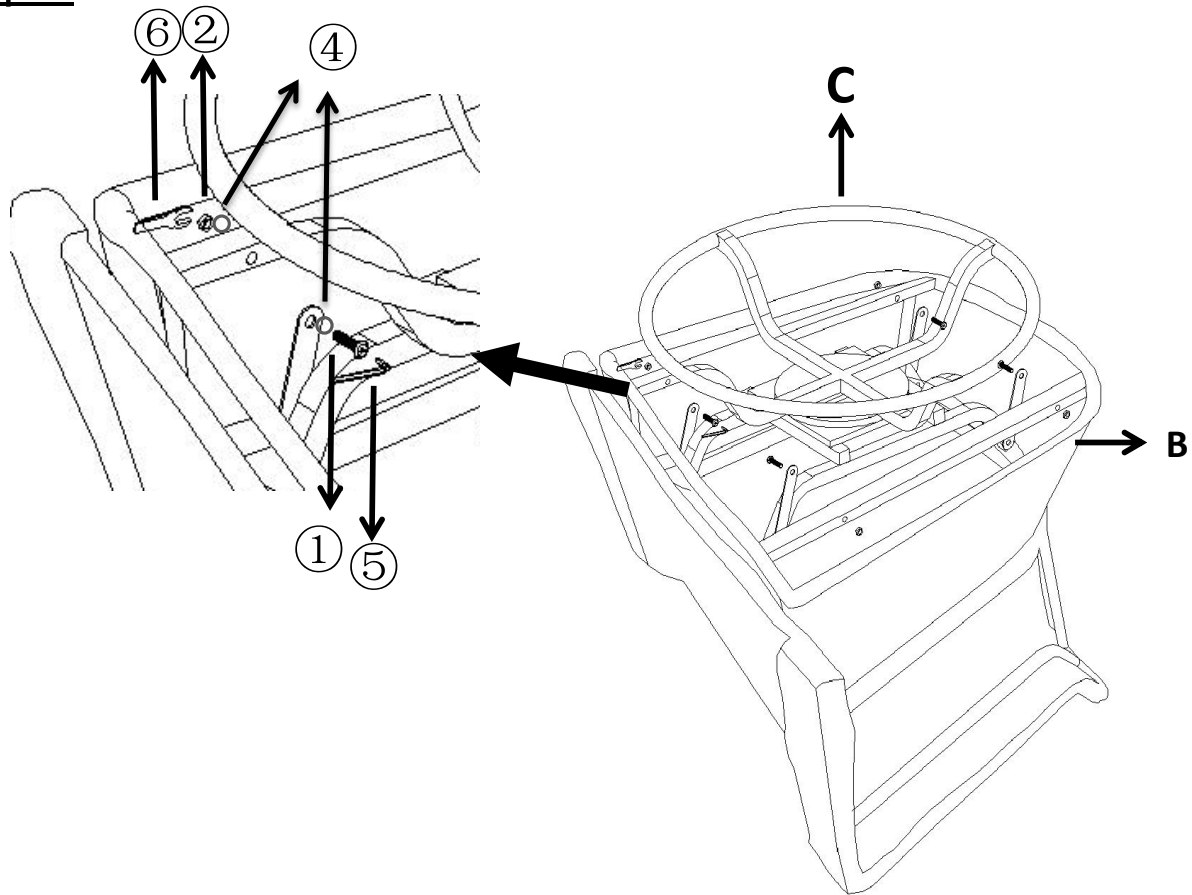

With the help of an adult partner, place the Chair Body facedown. Attach Swivel Plate(C) to Base(B) using Bolts(①), Washers(④) and Nuts(②) with Allen Key(⑤) and Wrench(⑥).

**Tighten Nuts and Bolts fully in a sequential manner.**



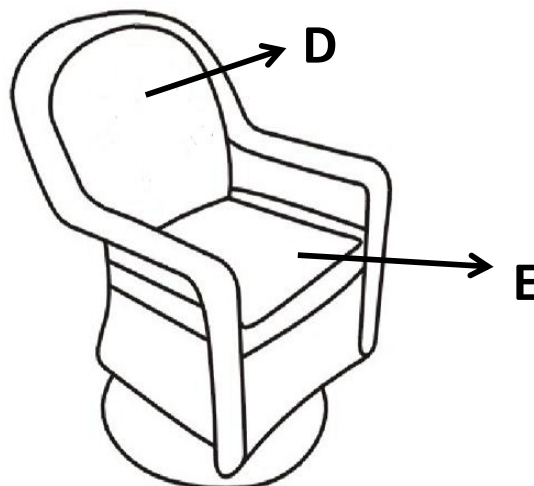

















### Step 4



Put the Seat Cushion(E) and Back Cushion(D) on the Chair. Your Chair is ready for use.

**This Chair can only be used on a flat, level surface.**

## Care & Maintenance

-   ● Do not put hot items directly on furniture surface
  -   ● Do not clean furniture with harsh cleansers or polish.
  -   ● To obtain the longest lifespan of your outdoor products, minimizing exposure to direct sunlight is recommended.
  -   ● Children should not climb or jump on the furniture.
  -   ● Do not write on furniture without a padded barrier to protect the surface.
  -   ● To obtain the longest lifespan of your outdoor products, avoid extended and lengthy exposure to rain, snow, and direct sunshine. Whenever possible cover the product and /or place under patio or awnings.
  -   ● Not for commercial use. For residential use only .
  -   ● Stains may be removed with mild soap solution and damp cloth.
  -   ● Keep away from sources of ignition.
- 
-   ● Dust and pick-up spills using a clean, non-colored, lint-free cloth.