

# ASSEMBLY INSTRUCTIONS

## CREAM-Q & BLACK-Q

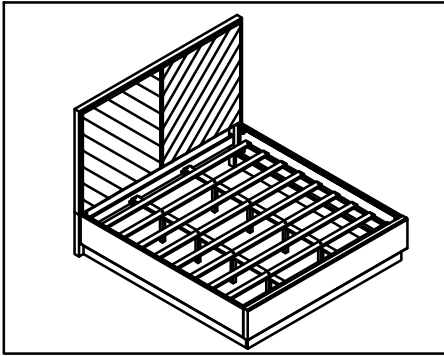

+ Do Not Use Power Tools

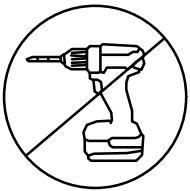

+ Suggested Adults

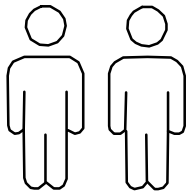

### NOTE:

- 1 Read instructions cover to cover.
- 2 Save all packaging until assembly is completed.

### + Parts Included

① Headboard (1 pcs)

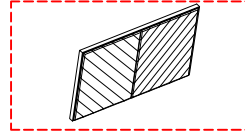

② Leg right (1 pcs)

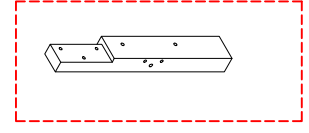

③ Leg left (1 pcs)

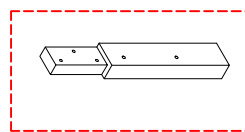

④ Stretcher (1 pcs)

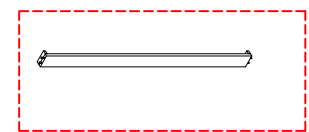

⑤ Footboard (1 pcs)

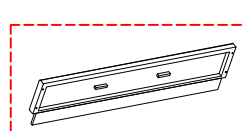

⑥ Side rail (2 pcs)

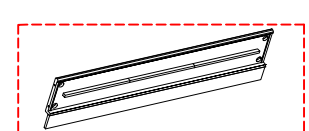

⑦ Center Support Slats (1 pcs)



⑧ Slats (9 pcs)

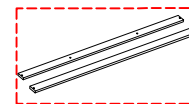

⑨ Support Legs (4 pcs)

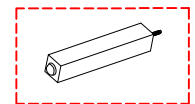

### + Hardware Included

A: Flat Washer ( 5/16"xØ19 ) (8 pcs)



B: Spring Washer ( 5/16"x Ø12 ) (8pcs)



C: Bolt ( 5/16" x 1-9/16" ) (8pcs)



D: Allen Key ( 4 x 3-1/8" ) (1 pcs)



E: Full Thread Bolt ( 5/16" x 3" ) = (8pcs)



F: Curve washer ( 5/16" ) (8pcs)



G: Hex. Nut ( Ø5/16" x 1/4" ) (8pcs)



H: Open Wrench ( #1/2" ) (1pcs)



j: Screw ( #4 x 1" ) (20pcs)



### 1 IMPORTANT SAFETY INFORMATION

Do not assemble the product if any of the following parts arrived damaged:

- |                    |                               |
|--------------------|-------------------------------|
| Part 1 - Headboard | Part 6 - Side rail            |
| Part 2 - Leg right | Part 7 - Center Support Slats |
| Part 3 - Leg left  | Part 8 - Slats                |
| Part 4 - Stretcher | Part 9 - Support Legs         |
| Part 5 - Footboard |                               |

### 2 IMPORTANT ASSEMBLY INFORMATION

**Assembly Step** Ensure the side rail bracket is fully hooked onto bolt loosely threaded with both washers on the OUTSIDE of the bracket first, then proceed to fully tightening all 4 corners.

# ASSEMBLY INSTRUCTIONS

## CREAM-Q & BLACK-Q

