

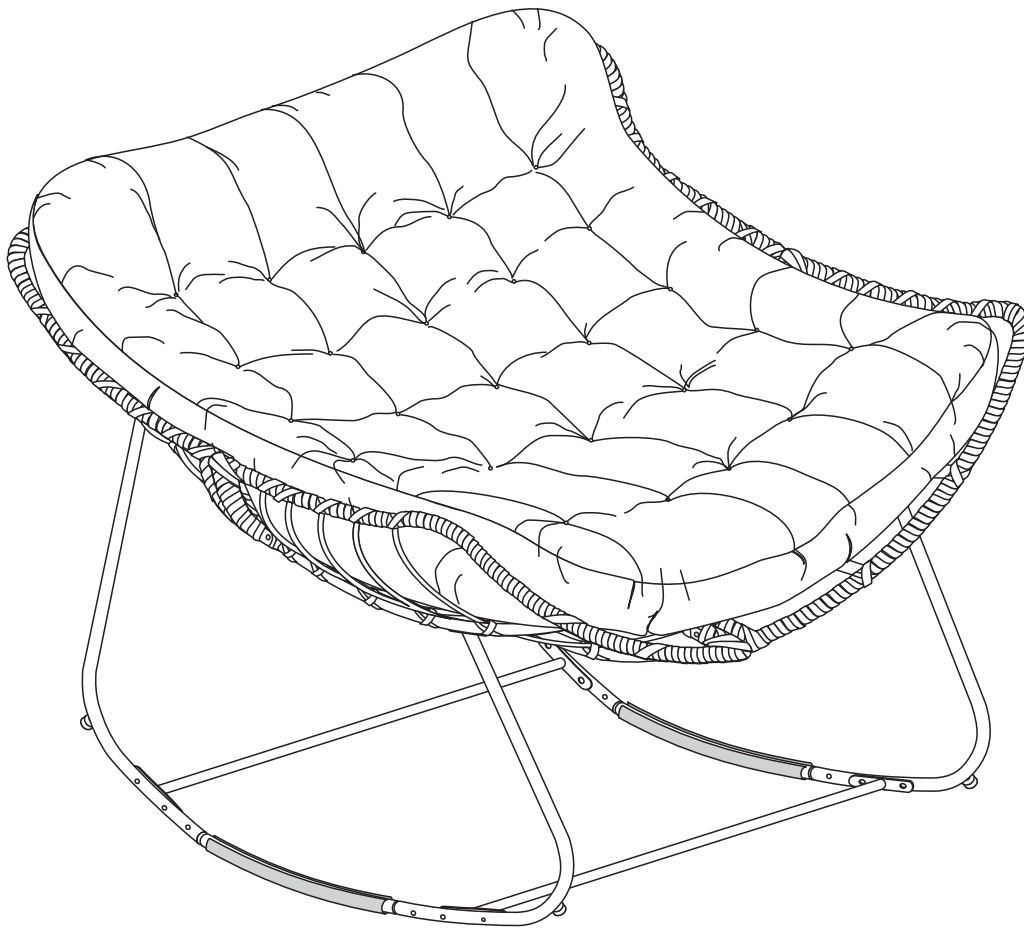





**EASY
ASSEMBLY**
Assemble in
25 minutes
or less

Rocking Chair

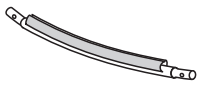

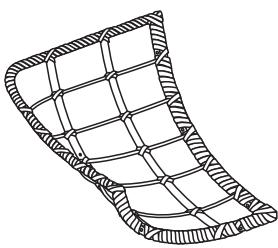
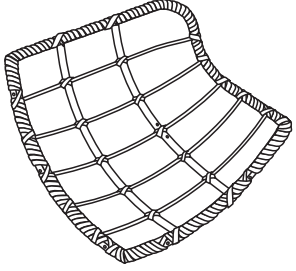
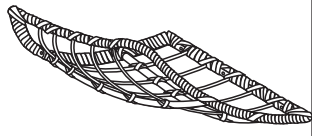
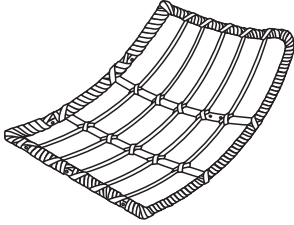
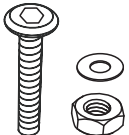
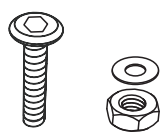
<p>1</p>  <p>2pcs</p>	<p>2</p>  <p>2pcs</p>	<p>3</p>  <p>2pcs</p>	<p>4</p>  <p>2pcs</p>
<p>5</p>  <p>1pcs</p>	<p>6</p>  <p>1pcs</p>	<p>7</p>  <p>1pcs</p>	<p>8</p>  <p>1pcs</p>
<p>A M6*60</p>  <p>10+1pcs</p>	<p>B M6*35</p>  <p>20+1pcs</p>	<p>C</p>  <p>1pcs</p>	<p>D</p>  <p>1pcs</p>
<p>E</p>  <p>1pcs</p>	<p>F</p>  <p>1pcs</p>		

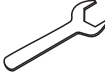
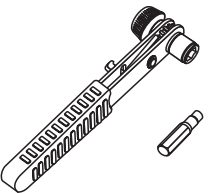
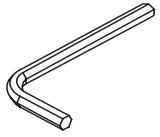
Notice: Install relevant screws, don't tighten completely at beginning Alignment & Tighten fully when you complete the seat base section.

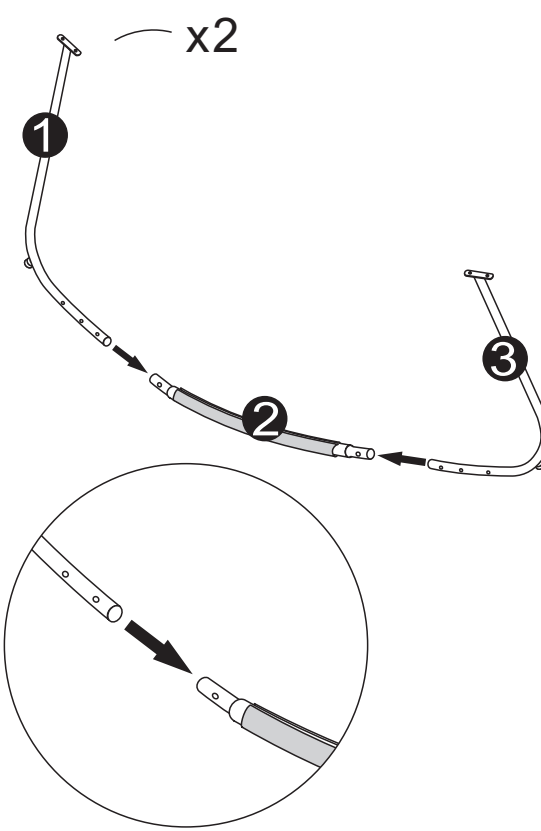
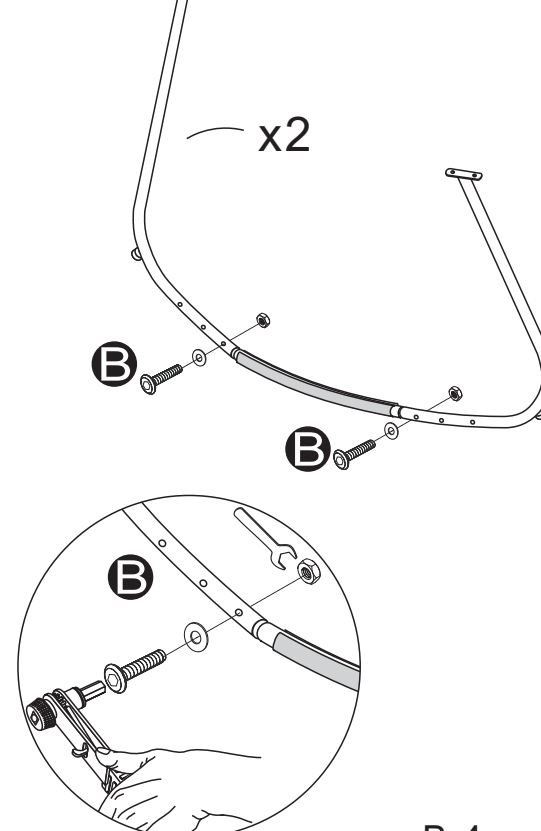
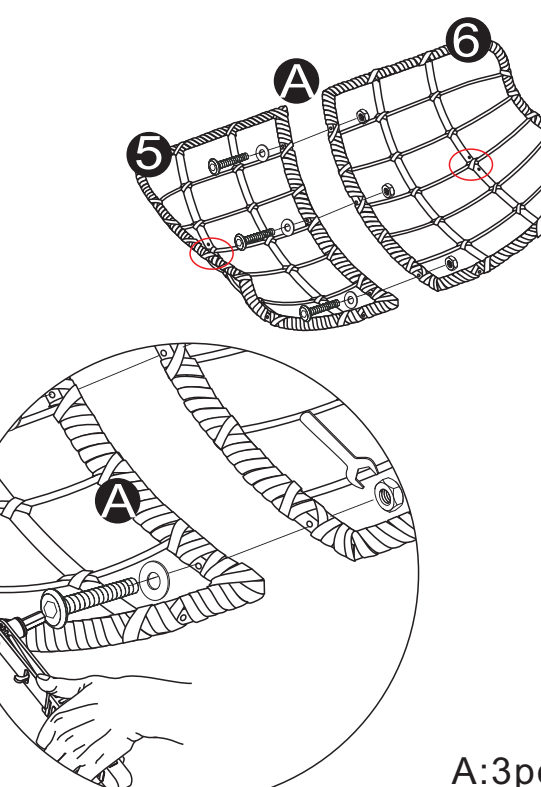
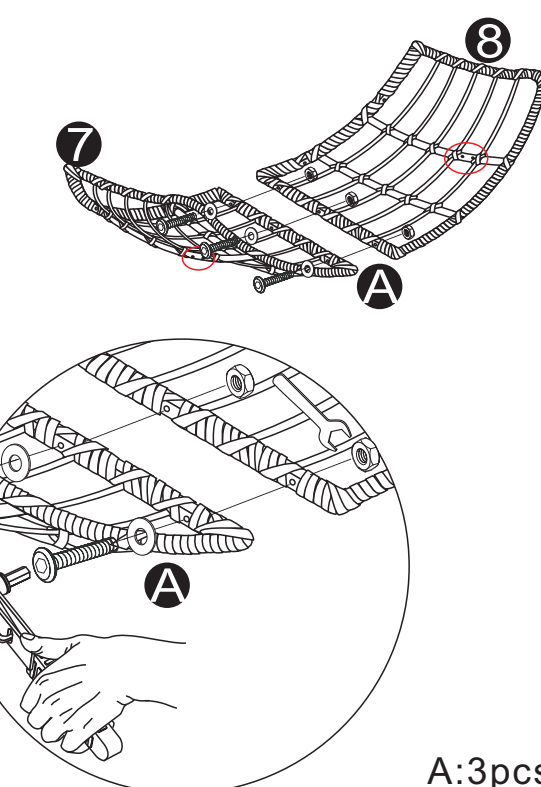
<p>1</p>  <p>x2</p> <p>1</p> <p>2</p> <p>3</p>	<p>2</p>  <p>x2</p> <p>B</p> <p>B</p> <p>B:4pcs</p>
<p>3</p> <p>Connect the two center-holed middle panels with screws.</p>  <p>5</p> <p>6</p> <p>A</p> <p>A</p> <p>A:3pcs</p>	<p>4</p> <p>Attach the two edge-holed side panels using screws.</p>  <p>7</p> <p>8</p> <p>A</p> <p>A</p> <p>A:3pcs</p>

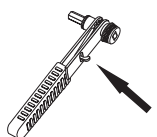

Forward and reverse ratchet switch

Notice: Install relevant screws, don't tighten completely at beginning
Alignment & Tighten fully when you complete the seat base section.

5 Combine the two assembled sections to finish.

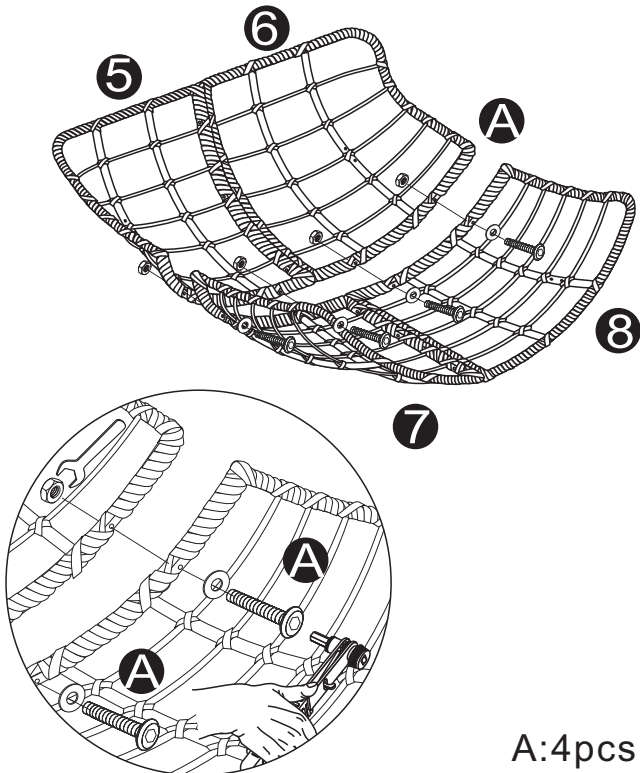

6 Align the short legs with the holes on the edge (outer position).
Secure each with screws.

