

Assembly Instructions

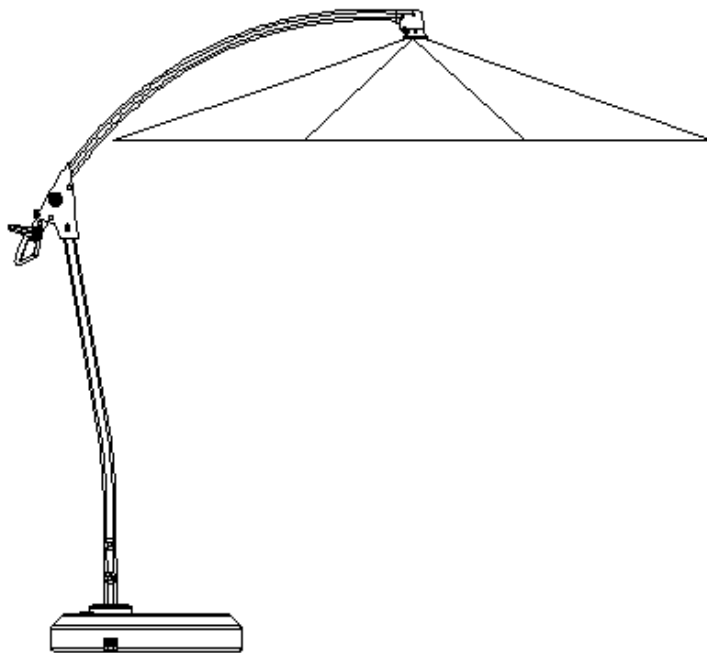

Caution : You must read this before you proceed



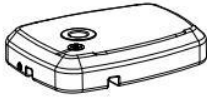

- 1. We suggest filling the Base with sand and water.**
- 2. If you notice the Base beginning to leak, please disassemble the Umbrella immediately.**

UMBRELLA









Parts List

Label	Picture	Description	QTY
A		Base	1
B		Cross Base	1
C		Cross Base	1

D		Umbrella Base Pole	1
E		Crank	1
F		Umbrella Frame & Canopy	1
G		Umbrella Pole	1

Hardware

Label	Picture	Description	QTY
①		Bolt (M8*20mm)	5
②		Washer	5
③		Hand Screw	2
④		Allen Key (6mm)	1
⑤		Allen Key (4mm)	1
⑥		Bolt (M6*12mm)	6

Assembly Preparation

Before Beginning Assembly:

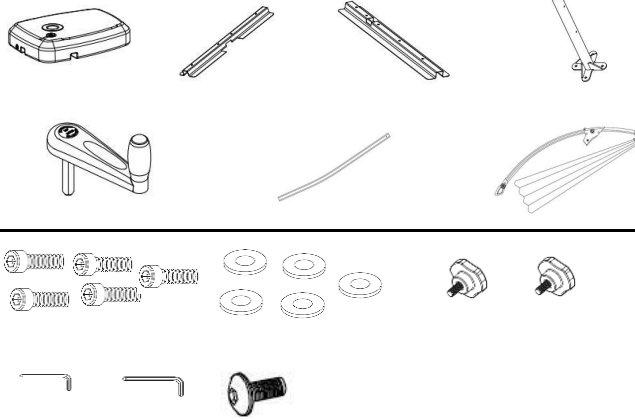

- Read instructions, cover to cover-



- Have 2 adults on hand for assembly-



- Do not assemble on flooring or carpet-



- Assemble on a clean non-marring surface (packing foam)-



- Save all packaging until finished-

Assembly Steps

Parts Introduction

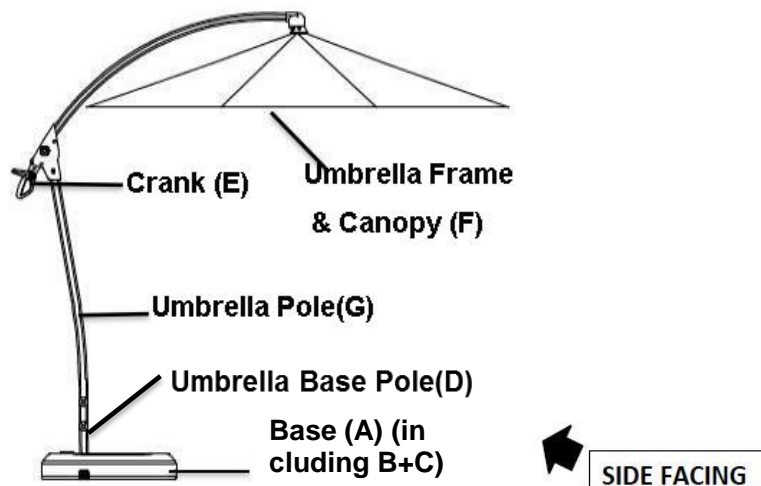

This Umbrella has multiple parts and may require up to 30 minutes to assemble. To give you an overview of the Umbrella parts, the above picture is to help you put the various parts into perspective. Please read through the instructions below to familiarise yourself with the parts and steps before assembly.

Step 1

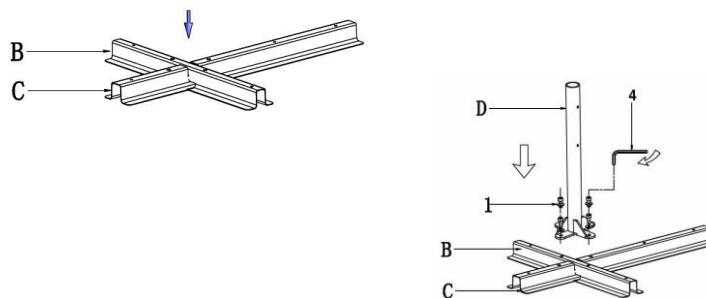

- 1.1) Put Cross Base(B) on Cross Base(C)
 - 1.2) Unpack and place all parts on a soft, non marring surface.
- Attach Base Pole(D) to Cross Base(B) and Cross Base(C) using Bolts(①), and Washers(②) with Allen Key(④).

Step 2

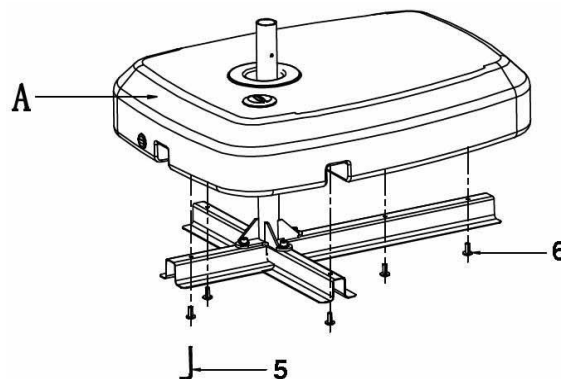

Attach Step1 assembled parts(B+C+D) to Base(A) using Bolts(⑥) with Allen Key(⑤).

Step 3

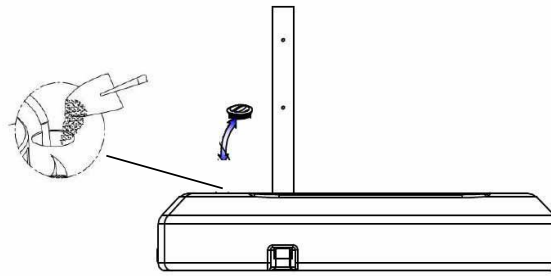

Fill the Base with a mixture of sand and water (in order to achieve the maximum weight, and increase the stability of the product, we suggest using this method).

twist off the plastic cap from the Base(A).

1. fill the base with a mixture of sand ,the weight is 82kgs
2. fill the base with a mixture of water ,the weight is 49.8kgs
3. fill the base with a mixture of water and sand ,the weight is 90kgs

This method will allow the Base to achieve the maximum weight of 90KGS.

Put the Plastic Cap back onto the Base(A).

Step 4

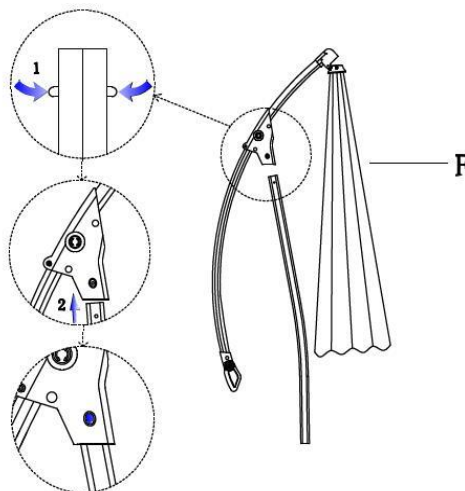

Insert the Umbrella Frame & Canopy(F) into the Umbrella Pole(G) as pictured.

When (G) the spring pin above all CARDS into the F of the base hole of the above said installed in place.

If there is no card into the hole location, please turn the (G) until saw two pin card into the hole. Otherwise you can't use.

Step 5

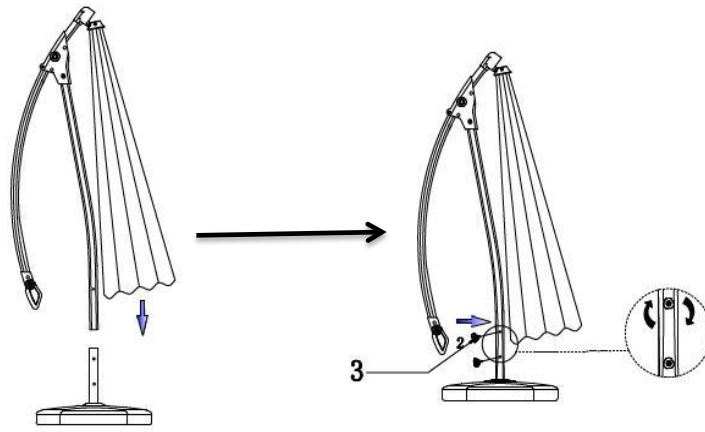

Insert the pole of the Umbrella Pole(G) onto the Umbrella Base Pole(D). Attach Umbrella Pole(G) to Umbrella Base Pole(D) using Hand Screws(③) by hand to ensure the Pole is tightly secured to the Base.

Step 6

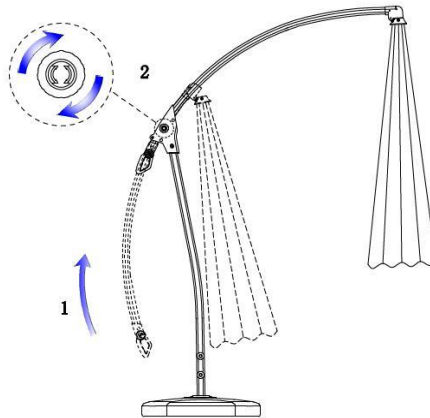

Unscrew the Knob, and slide the Umbrella Frame & Canopy(F) to your desired height. Tighten the Knob.

Step 7

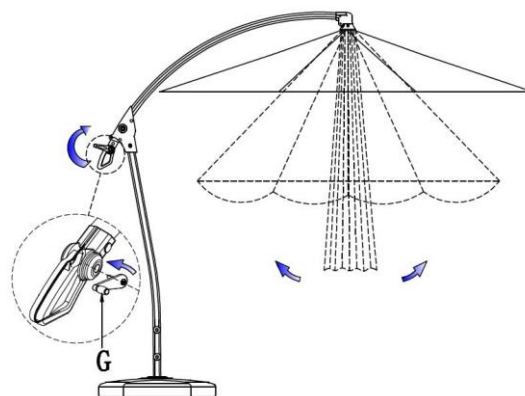

Insert the Crank(E) into the Hand Grip on the Umbrella Frame & Canopy(F). Then open the Umbrella Canopy by rotating the Crank(E) clockwise to open; counter clockwise to close.

Step 8

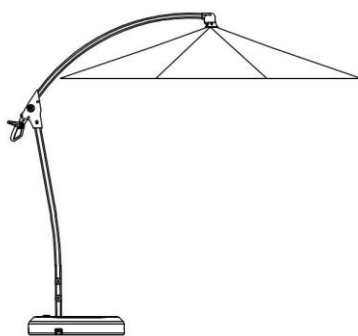



















Your Umbrella is now ready for use.

This Umbrella can only be used on a flat, level surface.

Always close the Umbrella when not in use and never use the Umbrella during strong, windy conditions.

The remove step is to reverse the use of this manual.

Care & Maintenance

-   ● Do not put hot items directly on furniture surface
 -   ● Do not clean furniture with harsh cleansers or polish.
 -   ● To obtain the longest lifespan of your outdoor products, minimizing exposure to direct sunlight is recommended.
 -   ● Children should not climb or jump on the furniture.
 -   ● Do not write on furniture without a padded barrier to protect the surface.
 -   ● To obtain the longest lifespan of your outdoor products, avoid extended and lengthy exposure to rain, snow, and direct sunshine. Whenever possible cover the product and /or place under patio or awnings.
 -   ● Not for commercial use. For residential use only .
 -   ● Stains may be removed with mild soap solution and damp cloth.
-
-   ● Dust and pick-up spills using a clean, non-colored, lint-free cloth .

Questions & Answers about Proposition 65

• What is Proposition 65?

Proposition 65 requires businesses to provide warnings to Californians about significant exposures to chemicals that cause cancer, birth defects or other reproductive harm. These chemicals can be in the products that Californians purchase, in their homes or workplaces, or that are released into the environment. By requiring that this information be provided, Proposition 65 enables Californians to make informed decisions about their exposures to these chemicals.

Proposition 65 also prohibits California businesses from knowingly discharging significant amounts of listed chemicals into sources of drinking water.

Proposition 65 requires California to publish a list of chemicals known to cause cancer, birth defects or other reproductive harm. This list, which must be updated at least once a year, has grown to include approximately 900 chemicals since it was first published in 1987.

• What types of chemicals are on the Proposition 65 list?

The list contains a wide range of naturally occurring and synthetic chemicals that include additives or ingredients in pesticides, common household products, food, drugs, dyes, or solvents. Listed chemicals may also be used in manufacturing and construction, or they may be byproducts of chemical processes, such as motor vehicle exhaust.

• What does a warning mean?

If a warning is placed on a product label or posted or distributed at a workplace, a business, or in rental housing, the business issuing the warning is aware or believes that it is exposing individuals to one or more listed chemicals.

By law, a warning must be given for listed chemicals unless the exposure is low enough to pose no significant risk of cancer or is significantly below levels observed to cause birth defects or other reproductive harm.

• Where can I get more information on Proposition 65?

If you have specific questions on the administration or implementation of Proposition 65, you can contact OEHHA's Proposition 65 program at P65.Questions@oehha.ca.gov, or by phone at (916) 445-6900.