





USER'S MANUAL

Twin Daybed and Trundle Frame Set





THIS INSTRUCTION BOOKLET CONTAINS **IMPORTANT** SAFETY INFORMATION. PLEASE READ AND KEEP FOR FUTURE REFERENCE.

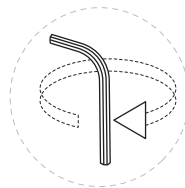
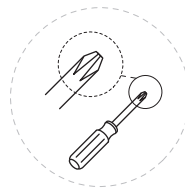
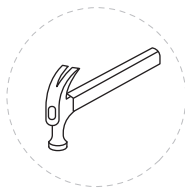
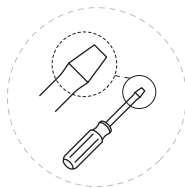

Before You Start

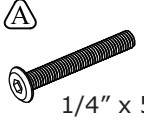
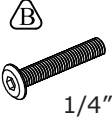
-  Read each step carefully before starting. It is very important to ensure each step followed in correct order, otherwise assembly difficulties may occur.
-  Most of board parts are labeled or stamped on the raw edges. Have a check to make sure all parts are included.
-  Work in a spacious area, preferably on a carpet close to where the unit will be used.
-  Keep the handtools close at hand. Do not use power tools to assemble your furniture. They may scratch or damage the parts.

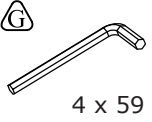

 <p>A 1/4" x 50 20PCS</p>	 <p>B 1/4" x 40 8PCS</p>	 <p>C 1/4" x 20 8PCS</p>	 <p>D LOCK 2PCS</p>	 <p>E NO LOCK 2PCS</p>	 <p>F 30 x 30 8PCS</p>	 <p>G 4 x 59 1PC</p>
--	---	---	--	---	---	---

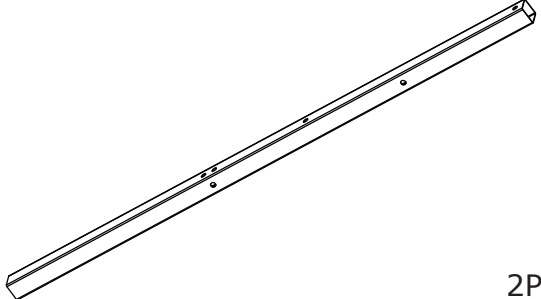
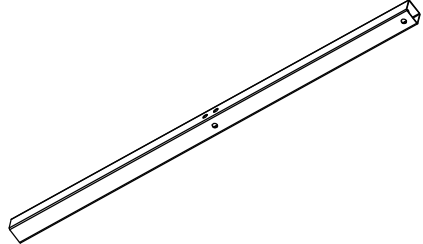
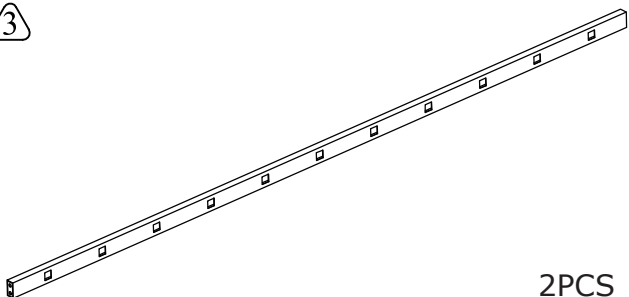
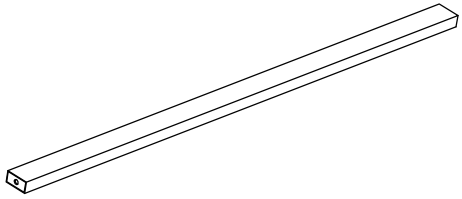
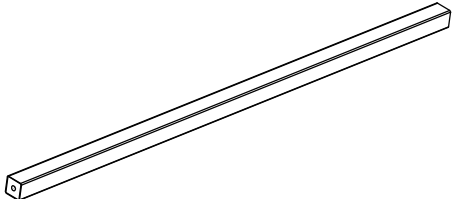
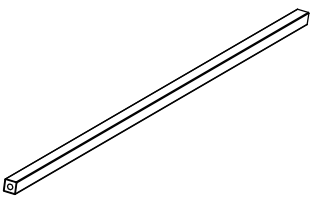
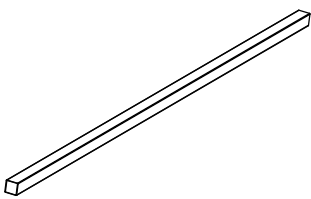
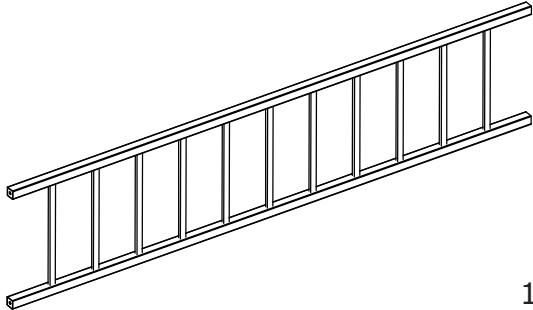
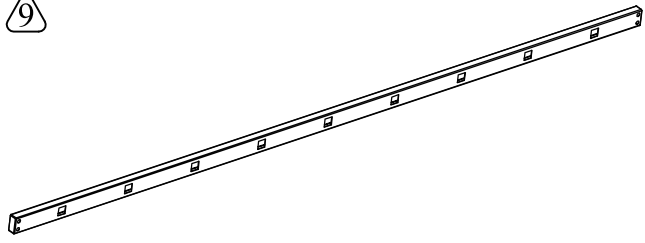
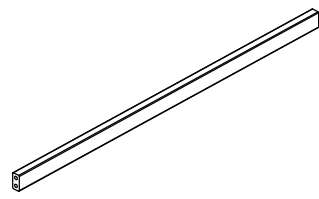
 <p>1 2PCS</p>	 <p>2 2PCS</p>
 <p>3 2PCS</p>	 <p>4 2PCS</p>
 <p>5 2PCS</p>	 <p>6 4PCS</p>
 <p>7 16PCS</p>	 <p>8 1PC</p>
 <p>9 2PCS</p>	 <p>10 2PCS</p>

IMPORTANT SAFETY NOTICE: READ CAREFULLY BEFORE BEGINNING ASSEMBLY!

- ⚠ Do not stand on for your safety.
- ⚠ Follow the assembly steps in order. Do not skip any steps.
- ⚠ Please do not tighten any screw before each is well placed in appropriate holes.
- ⚠ Please tighten up all screws before usage to avoid any potential safety hazard.
- ⚠ Please double check to ensure all the screws are well placed in appropriate holes if any assembly issue occurs.
- ⚠ Be sure to check all packing materials carefully for small parts may have come loose inside the carton during shipment. If parts are missing contact the retailer from which you purchased the product to obtain any missing parts. **DO NOT USE SUBSTITUTE PARTS.**
- ⚠ Keep the instructions for future reference.

STEP 1

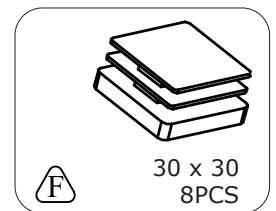
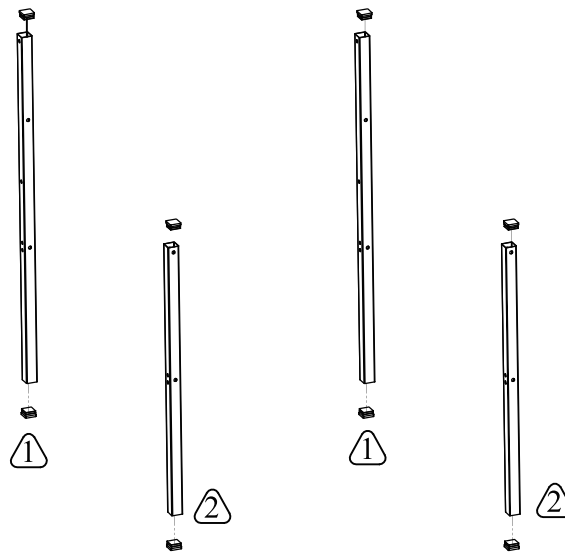

STEP 2 2 SETS

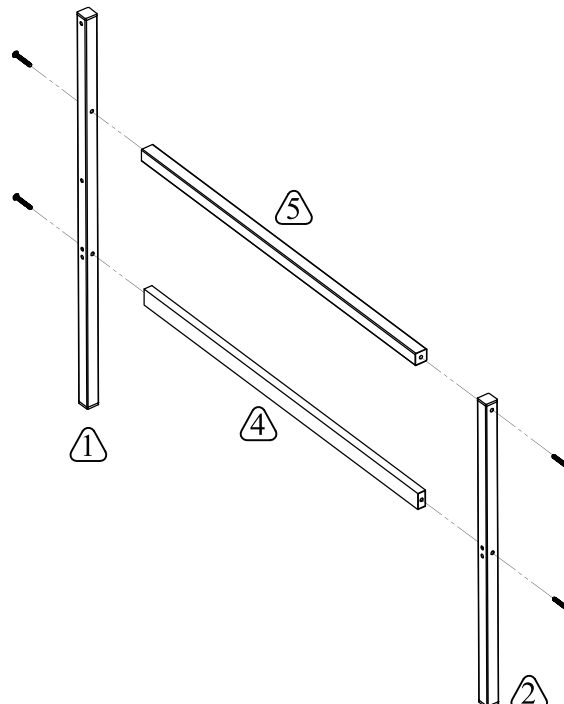

2 X

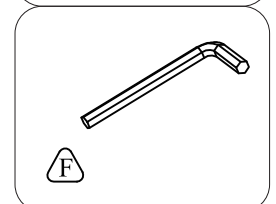
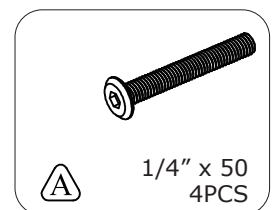

STEP 3

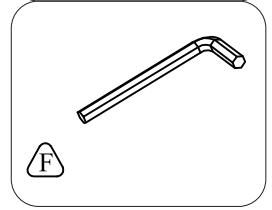
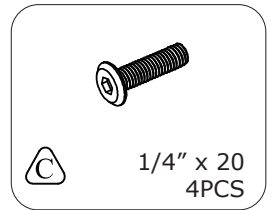
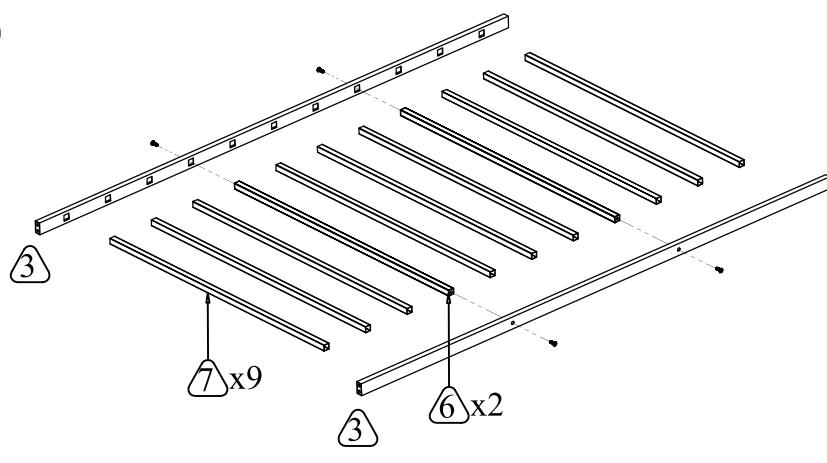

STEP 4

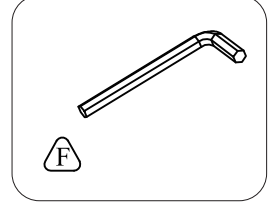
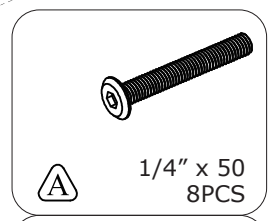
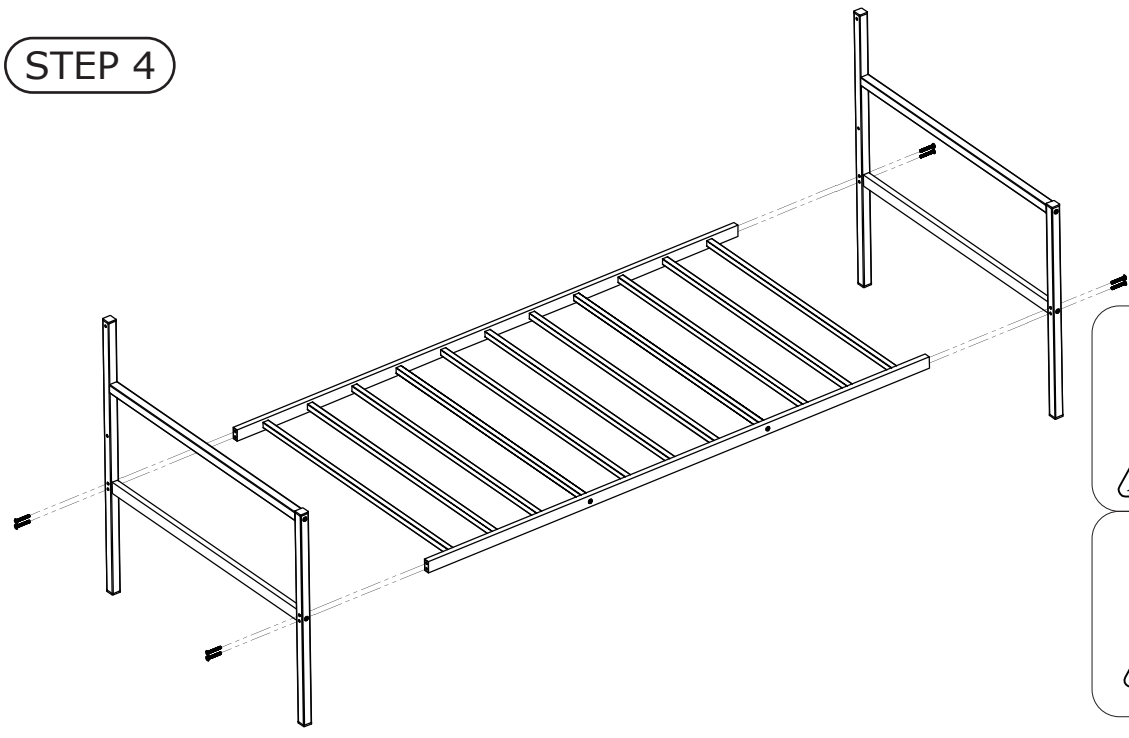

STEP 5

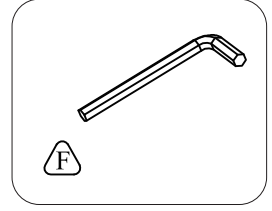
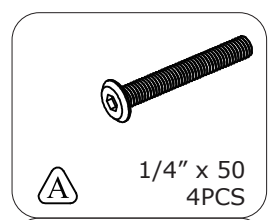
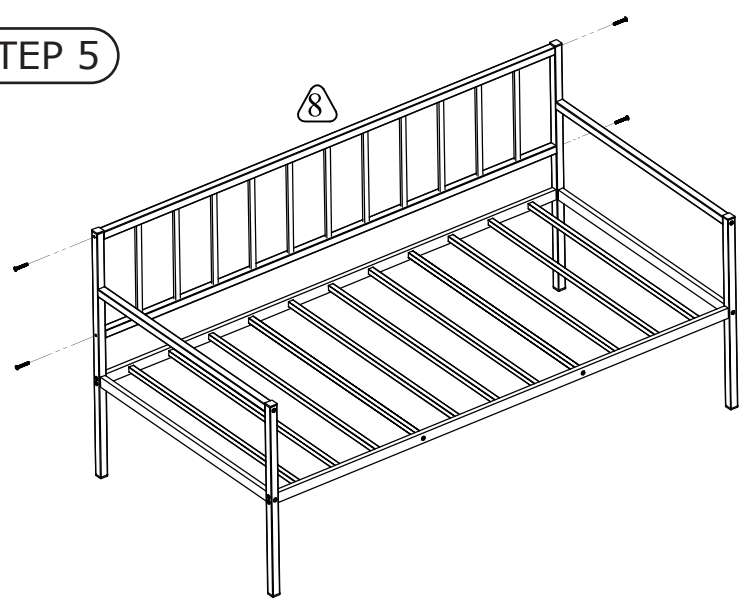

STEP 6

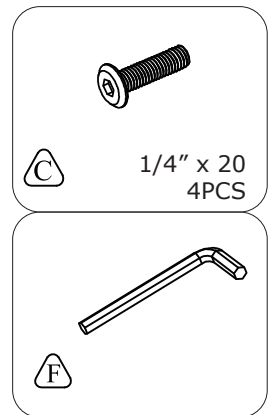
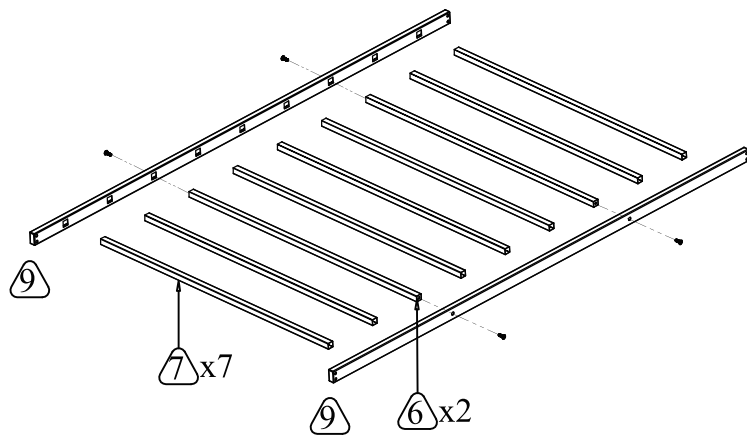

STEP 7

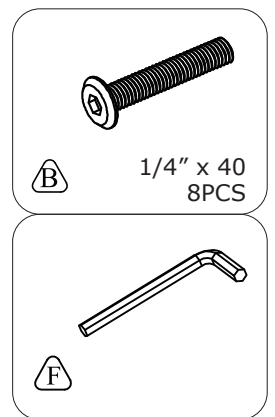
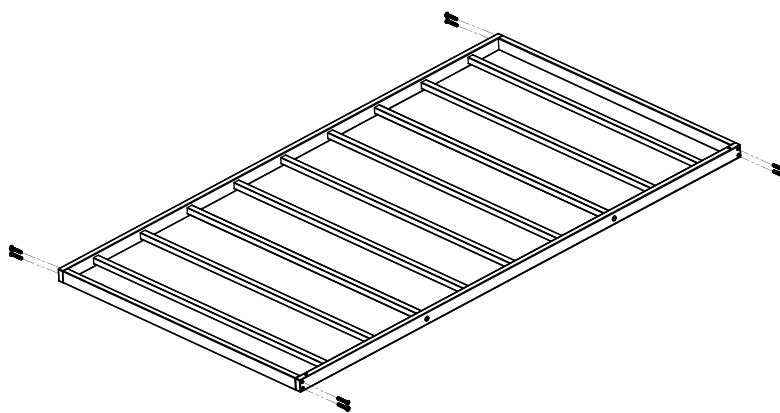

STEP 8

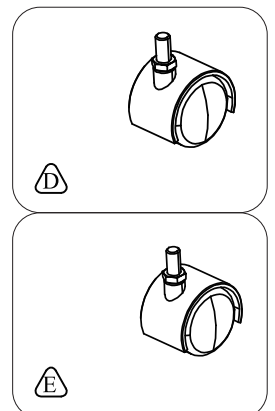
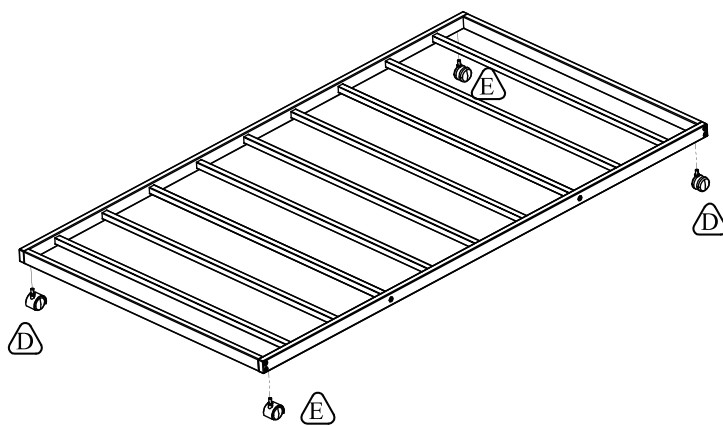

Care and Maintenance

Use a soft, clean cloth that will not scratch the surface when dusting.

Use of furniture polish is not necessary.

Should you choose to use polish, test first in an inconspicuous area.

Using solvents of any kind on your furniture may damage the finish.

Never use water to clean your furniture as it may cause damage to the finish.

Liquid spills should be removed immediately. Using a soft clean cloth, blot the spill gently. Avoid rubbing.

Check bolts/screws periodically and tighten them if necessary.

Further advice about wood furniture care

It is best to keep your furniture in a climate-controlled environment. Extreme temperature and humidity changes can cause fading, warping, shrinking and splitting of wood.

It is advised to keep furniture away from direct sunlight as sun may damage the finish.

Proper care and cleaning at home will extend the life of your purchase.

Following these important and helpful tips will enhance your furniture as it ages.