

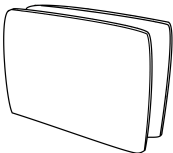



ASSEMBLY INSTRUCTION

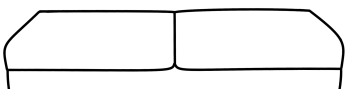
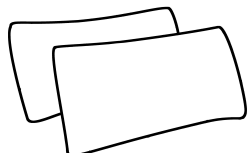

READ THIS INSTRUCTIONS CAREFULLY. SEE FURNITURE HARDWARE AND PART LIST FOR GUIDANCE. BE SURE ALL PARTS ARE COMPLETE BEFORE YOU ASSEMBLE. FOLLOW THE FIGURE TO START ASSEMBLING.

NOTE: THE LIST AND QUANTITY SHOWN ARE FOR 1 UNIT ASSEMBLY.

PART LIST

A. Armrest  2 PCS	B. Backrest  1 PC	C. Base  1 PC	D. Back Cushion  2 PCS	E. Pillow  2 PCS
F. Leg  4 PCS	CAUTIONS: <ol style="list-style-type: none">1. DO NOT USE A POWER TOOL-to assemble this product. Its use may cause damage to the thread.2. DO NOT FULLY-Tighten the nut or bolt until all nut or bolt is ready assembled.3. DO NOT OVER-Tighten the nut or bolt to avoid causing damages to the thread.4. Keep all hardware parts out of reach of children.			

HARDWARE LIST

G. Flat Washer  6 PCS	H. Bolt (M8x25)  6 PCS	I. Allen Wrench  1 PC
---	--	--

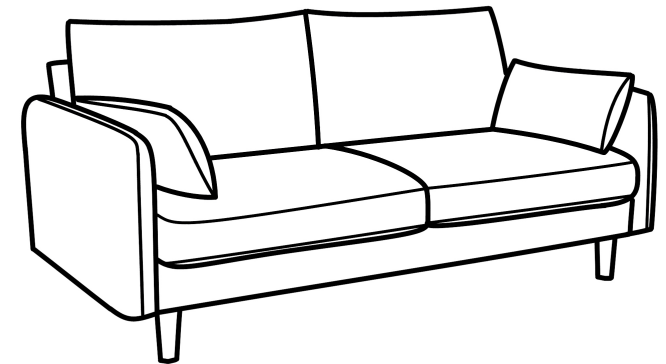

ATTENTION:

THIS ITEM SHOULD BE ASSEMBLED ON A SOFT SURFACE TO PREVENT SCRATCHING DURING ASSEMBLY.

STEP 1 : Open the zipper at the bottom of the Base (C). From the bottom you can then take out the Back Cushions (D), Pillows (E), Legs (F) and Hardware (G) (H) (I).

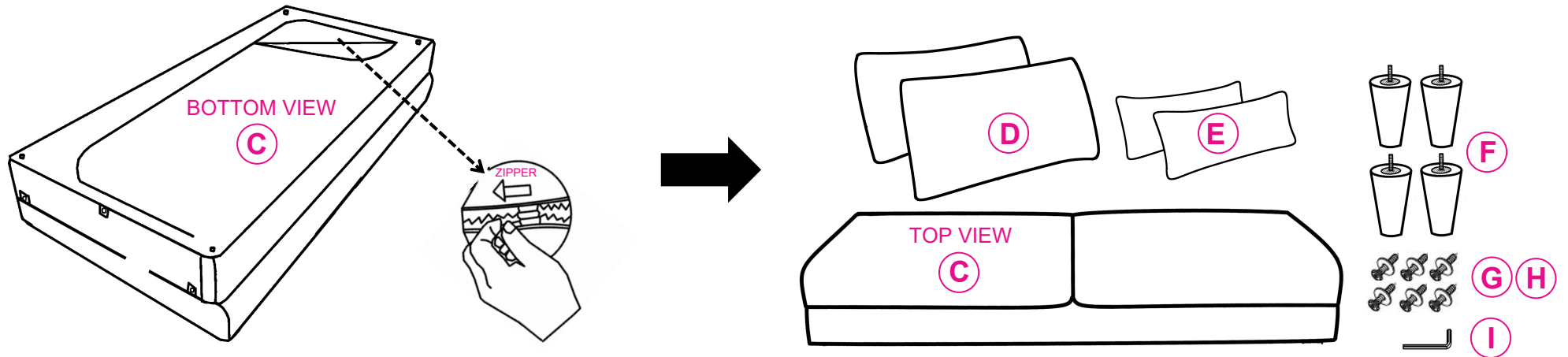

STEP 2 : (1) To assemble the Armrest (A), first align the holes of the Armrest (A) to the side of the Base (C) and (2) secure by inserting Bolt (H) with Flat Washer (G) from inside the Base (C). Follow picture and NOTE below. (3) Close the zippers.

2.1

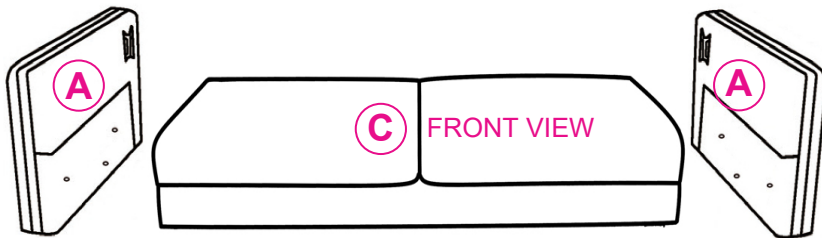

2.4

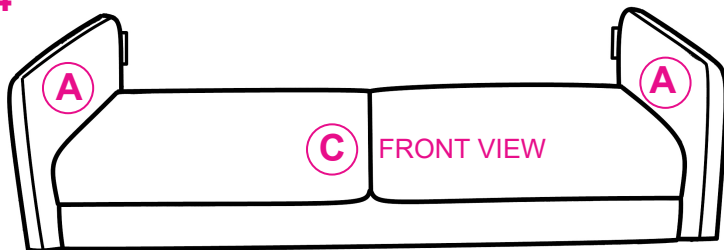

2.2

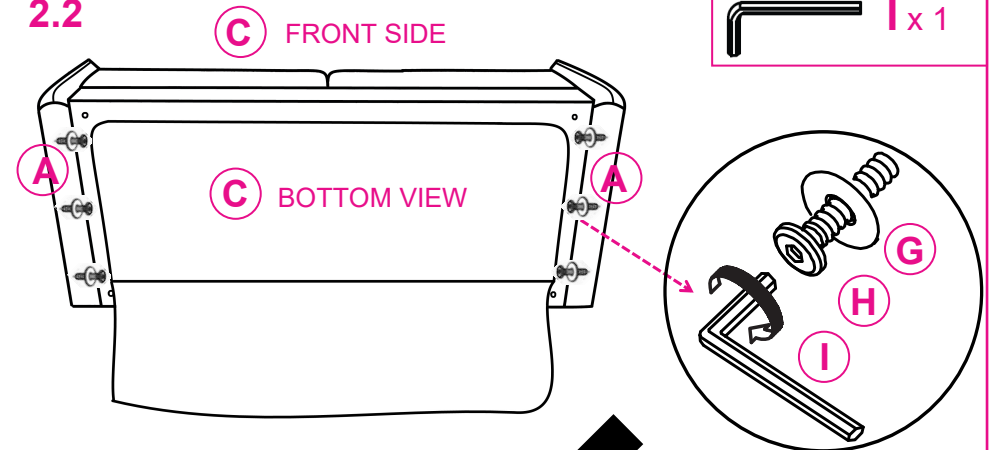

2.3 NOTE:

Insert the Bolt (H) onto the MIDDLE hole first. DO NOT tighten it up all the way until each Bolt is placed on left and right holes. Once all 3 Bolts are in place then tighten with Allen Wrench (I).

STEP 3 : Install the Legs (F) by twisting

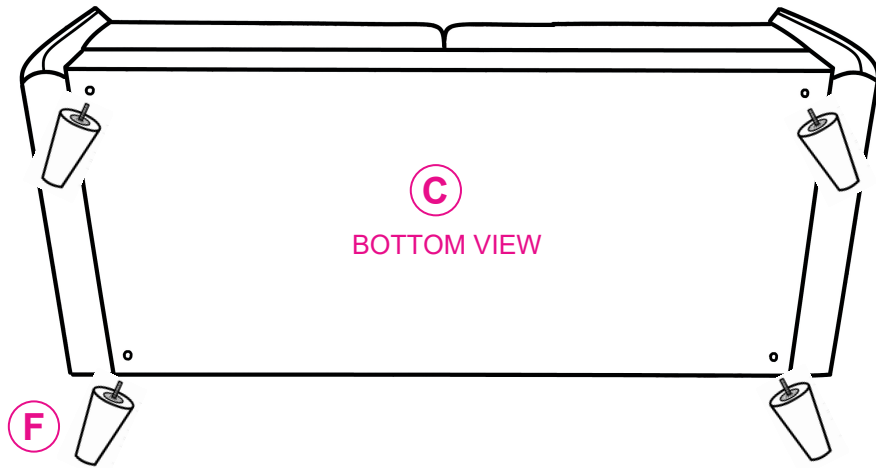

STEP 4 : Attach the Backrest (B) to the back of Base (C) by aligning the metal brackets and push them down until clicked.

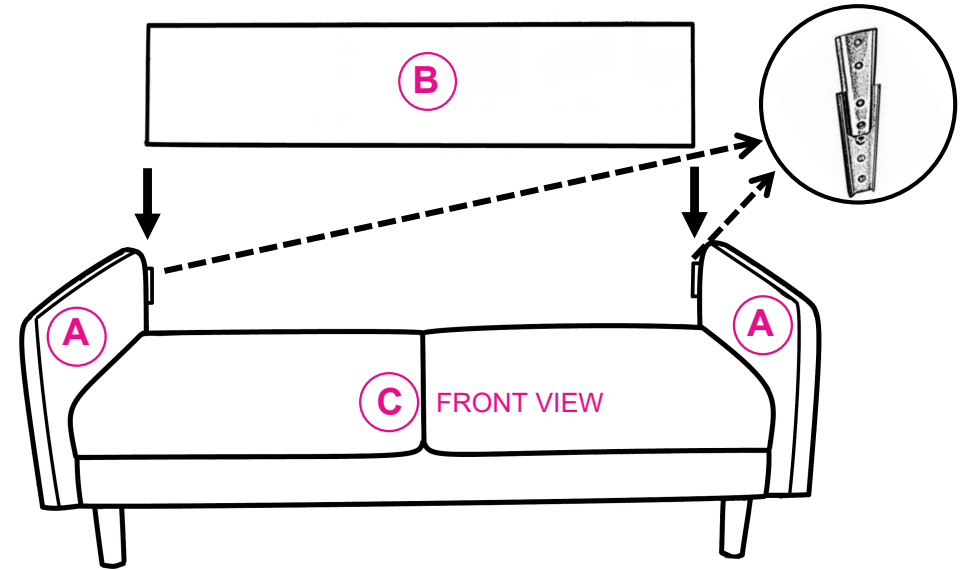

STEP 5 : After install the Backrest (B), pull down rear cover on the Backrest (B) evenly and secure the velcro strip to the Base (C).

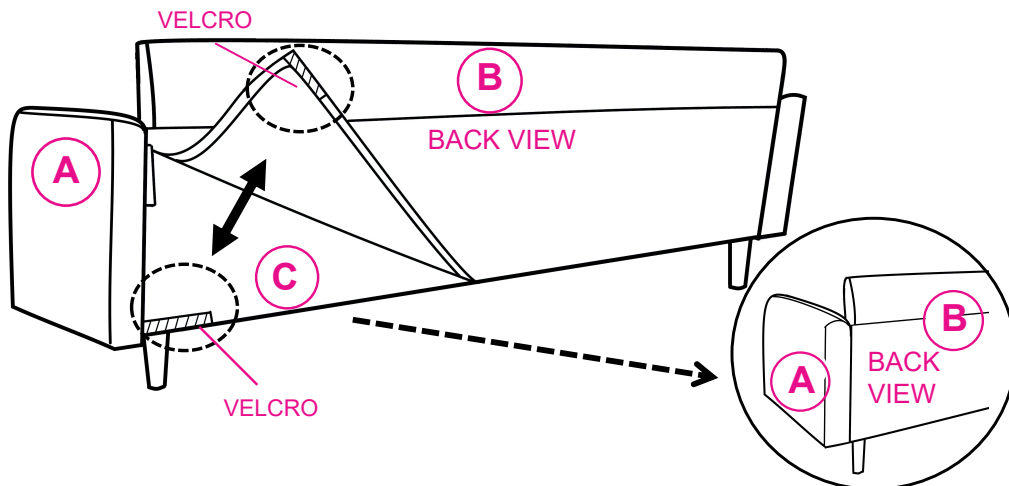

STEP 6 : Place the Back Cushions (D) and Pillows (E) on the sofa as shown on picture below.

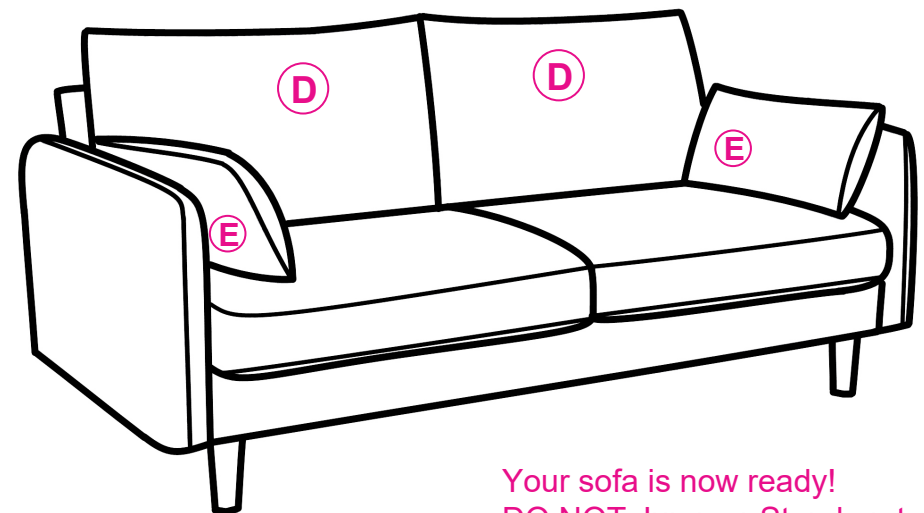

Your sofa is now ready!
DO NOT Jump or Stand on top!