

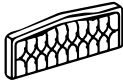









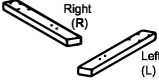





ASSEMBLY INSTRUCTIONS

**NOTE : THIS ITEM NOT RECOMMENDED FOR COMMERCIAL USE
KEEP THIS DOCUMENT FOR REFERENCE IN CASE PARTS ARE NEEDED**

DO NOT TIGHTEN SCREWS UNTIL COMPLETELY ASSEMBLED !!

NO		DESCRIPTION	QTY
A		Headboard	1pc
B		Footboard	1pc
C		Side Rail	2pcs
D		Headboard Legs	2pcs
E		Support Legs	4pcs
F		Legs	5pcs
G		Slat	8pcs

NO		DESCRIPTION	QTY
1		JCBB M8 x 30	8pcs
2		JCBC M6 x 40	4pcs
3		JCBC M6 x 50	8pcs
4		JCBC M6 x 70	5pcs
5		Wrench Key 100mm	1pc
6		Wrench Key 70mm	1pc
7		CSK Screw 32mm	16pcs
8		Spring Washers	8pcs
9		Flat Washers	8pcs
10		Adjuster	4pcs

ASSEMBLY INSTRUCTIONS

STEP 1 :

Open the footboard drawer (B) and take out all the part out.

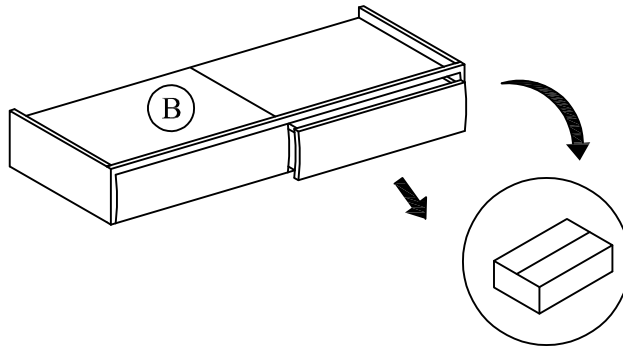

STEP 2 :

Fix the headboard (A) and headboard legs (D) with legs as shown.

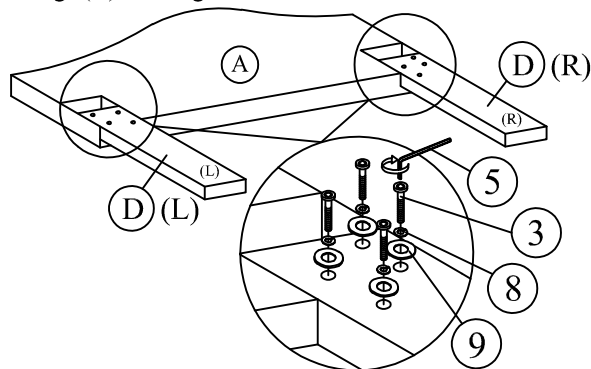

STEP 3 :

Tighten the legs (F) to both headboard (A) and footboard (B) as shown.

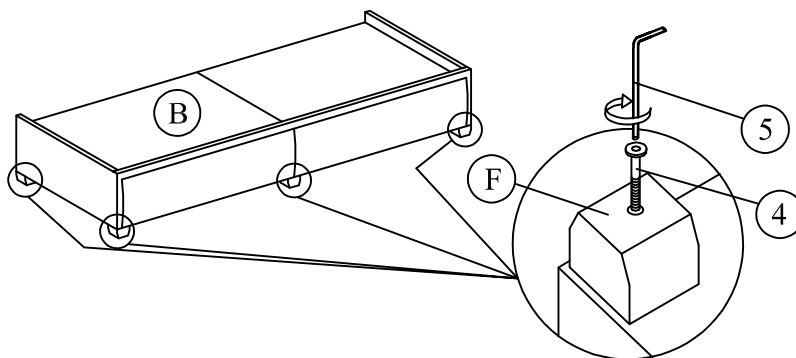

ASSEMBLY INSTRUCTIONS

STEP 4 :

Attach side rail (C) to headboard (A) and footboard (B) by pushing the bracket down to fit it.

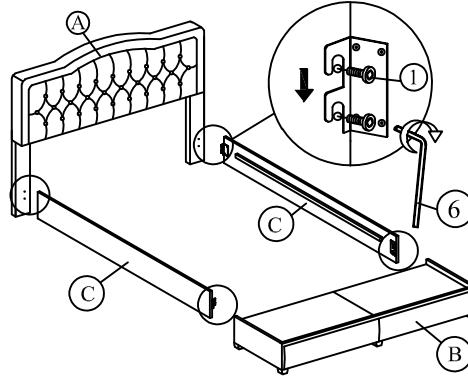

STEP 5 :

Attach the support legs (E) to the slats (G) of the bed as shown.

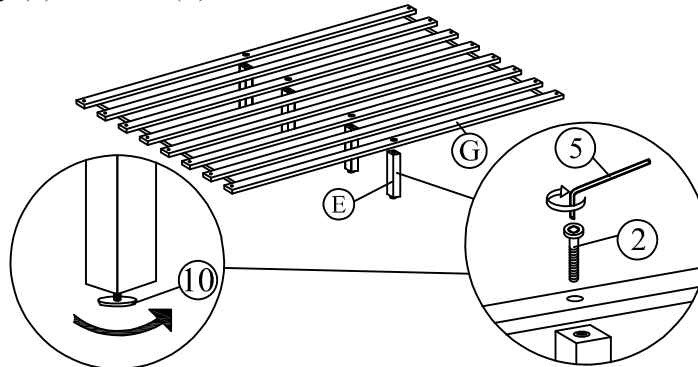

STEP 6 :

Affix the Slat (G) to the side rail support wood. Tighten all the 4 corner.

