

BEFORE ASSEMBLY NOTICE





2 persons



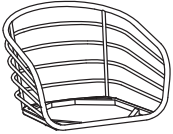
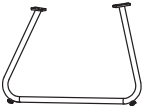
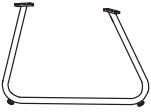

20min assembly

PART LIST (NOT SHOW ACTUAL SIZE)

A	X1	B	X1	C	X1
					
		Left		Right	
G	X1	H	X1		
					

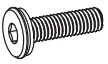
HARDWARE LIST (NOT SHOW ACTUAL SIZE)

D	X8	E	X8
			
M6X15mm		M6	





Attention:

Please do not tighten each screw during each installation step. After completing all installation steps, tighten all screws.

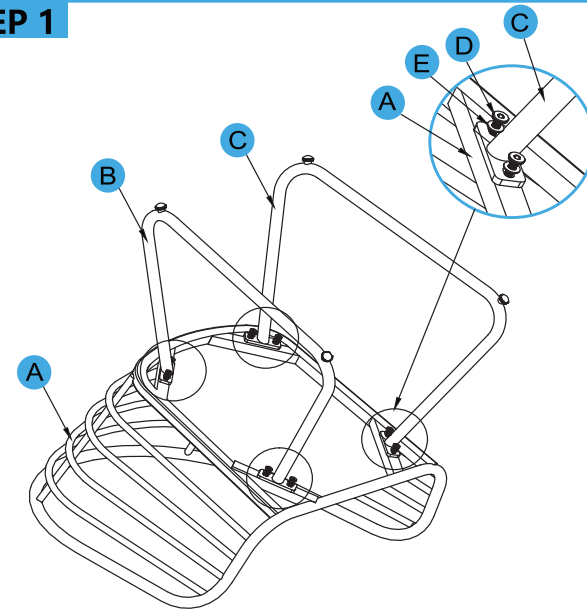
ASSEMBLY STEPS (NOT SHOW ACTUAL SIZE)

STEP 1



A	X1
	
B	X1
	
C	X1
	
D	X8
	
E	X8
	

STEP 2

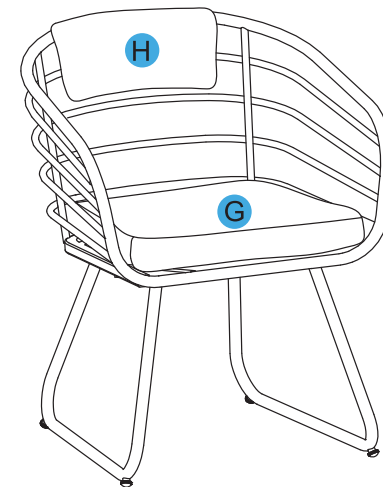

G	X1
	
H	X1
