

ASSEMBLY INSTRUCTION

INSTRUCTIONS DE MONTAGE

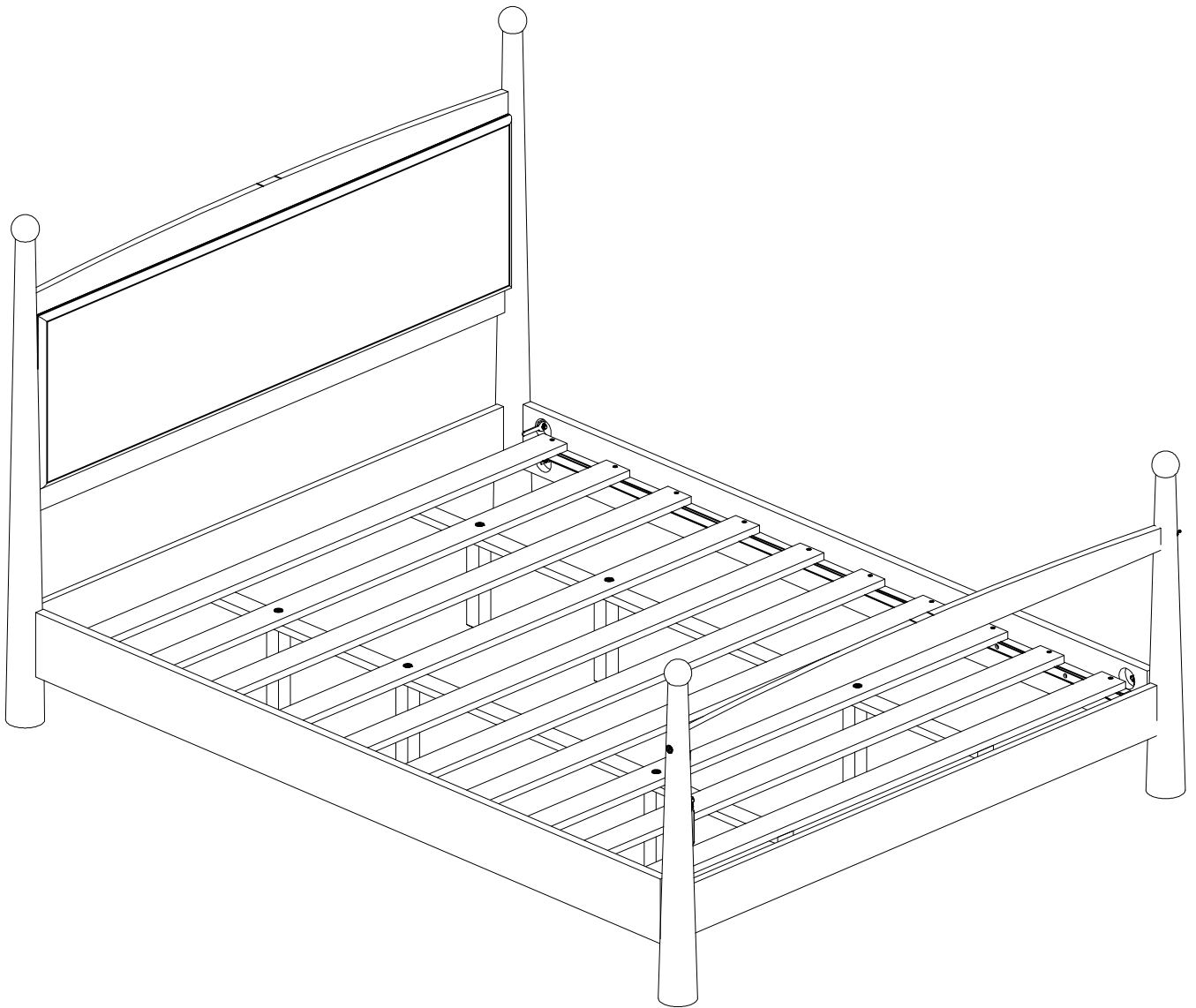

ASSEMBLY INSTRUCTION

INSTRUCTIONS DE MONTAGE

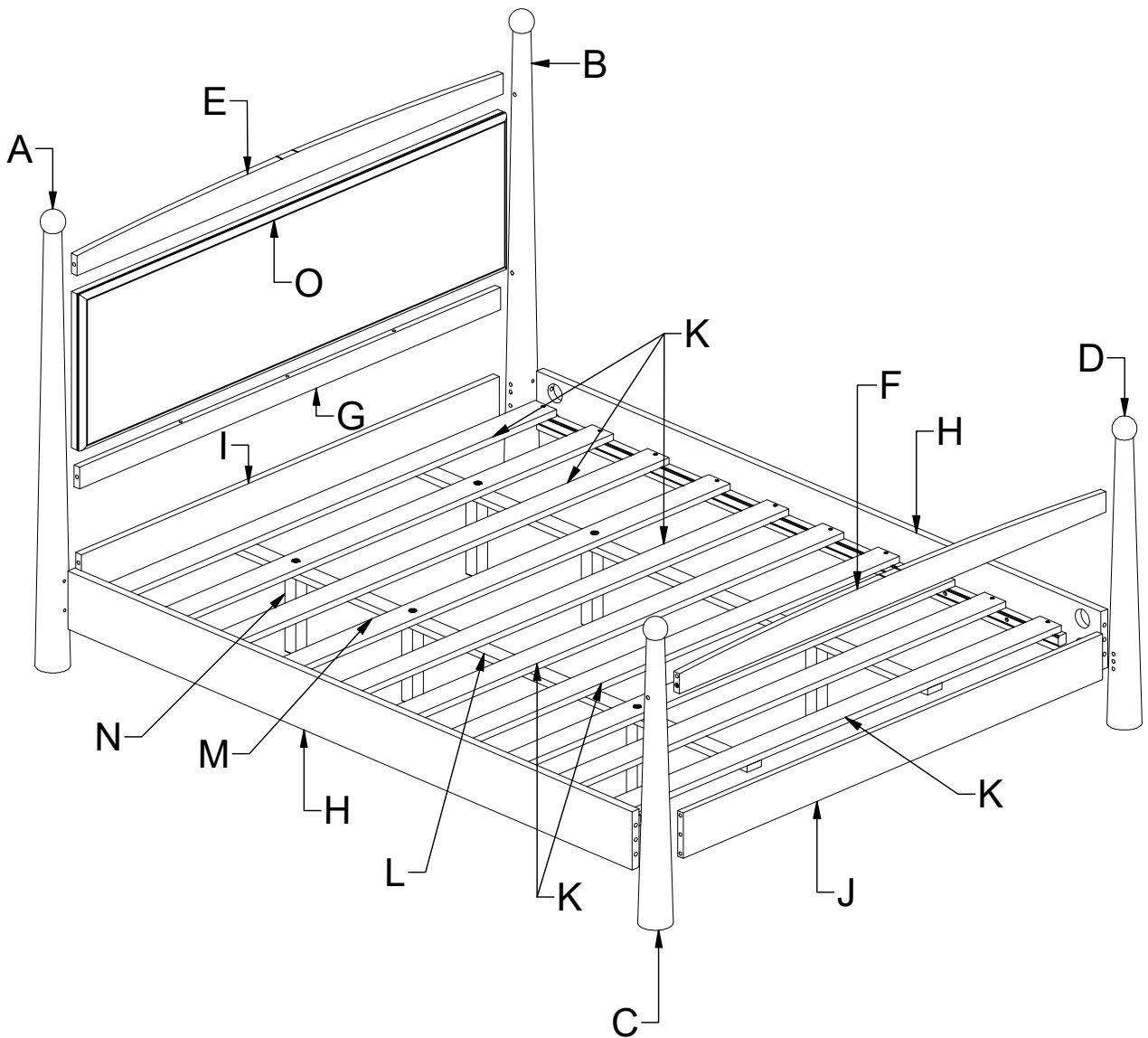

ASSEMBLY INSTRUCTION

INSTRUCTIONS DE MONTAGE

PART LIST

LISTE DES PIÈCES

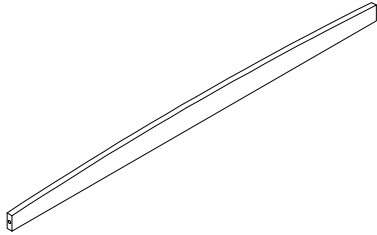
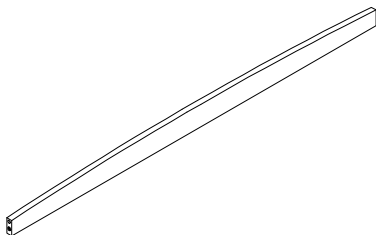
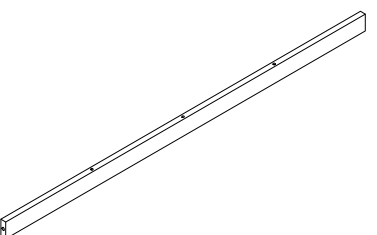
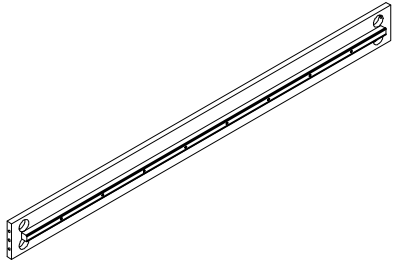
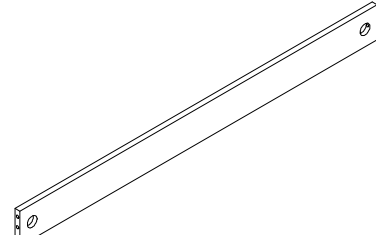
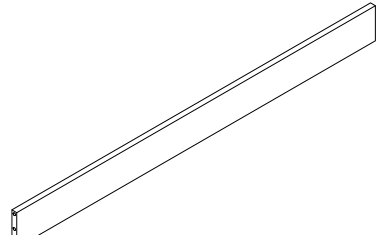
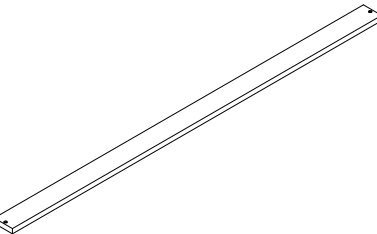
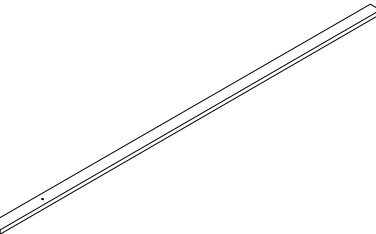
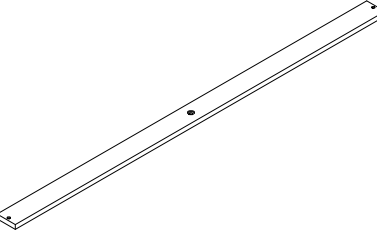
<p>E</p>  <p>HB HORIZONTAL - 1 PC HB HAUT HORIZONTAL - 1 PC</p>	<p>F</p>  <p>FB HORIZONTAL - 1 PC FB HAUT HORIZONTAL - 1 PC</p>	<p>G</p>  <p>HB CENTRE HORIZONTAL - 1 PC CENTRE HB HORIZONTAL - 1 PC</p>
<p>H</p>  <p>SIDE RAIL - 2 PC RAILS LATERAUZ - 2 PCS</p>	<p>I</p>  <p>HB BOTTOM HORIZONTAL - 1 PC HB BAS HORIZONTAL - 1 PC</p>	<p>J</p>  <p>FB BOTTOM HORIZONTAL - 1 PC FB HORIZONTAL INFERIEUR - 1PC</p>
<p>K</p>  <p>SLAT (A) - 7 PCS LAME (A) ; 7 PCS</p>	<p>L</p>  <p>CENTRE SUPPORT - 2 PCS LAME CENTRE - 2 PCS</p>	<p>M</p>  <p>SLAT (B) - 3 PCS LAME (B) - 3 PCS</p>

ASSEMBLY INSTRUCTION

INSTRUCTIONS DE MONTAGE

PART LIST

LISTE DES PIÈCES

A



HB POST (A) - 1 PC
POSTE HB (A) - 1 PC

B



HB POST (B) 1 PC
POSTE HB (B) - 1.PC

C



FB POST (A) - 1 PC
POSTE FB (A) - 1 PC

D



FB POST (B) - 1 PC
POSTE FB (B) - 1 PC

N

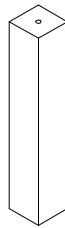

SUPPORT LEG - 6 PCS
JAMBE DE SUPPORT - 6 PCS

O

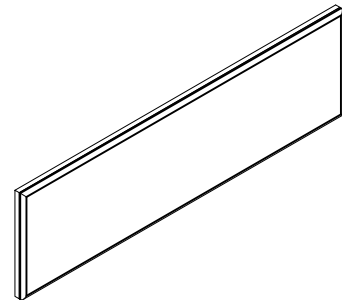









CUSHION PANEL - 1 PC
PANNEAU DE COUSSIN - 1 PC

ASSEMBLY INSTRUCTION

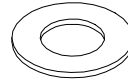
INSTRUCTIONS DE MONTAGE

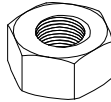
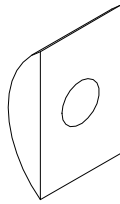
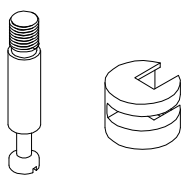
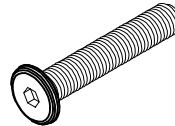
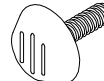
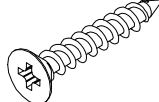
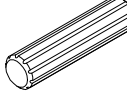

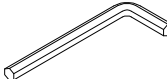
PART LIST

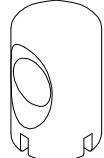
LISTE DES PIÈCES

<p>1</p>  <p>JCBC BOLT M6 x 90MM - 2 PCS BOULAN JCBC M6 x 90MM - 2PCS</p>	<p>2</p>  <p>STULD BOLT M8 x 60MM - 16 PCS GOUJON M8 x 60MM - 16 PCS</p>	<p>3</p>  <p>FLAT WASHER M8 OD16 x ID8.5 x T1.5 - 16 PCS RONDELLE PLATE M8 OD16 x ID8,5 x T1,5 - 16 PCS</p>
<p>4</p>  <p>SPRING WASHER 0.5/1M x 13MM 16 PCS RONDELLE RESSORT 0.5/1M x 13MM - 16 PCS</p>	<p>5</p>  <p>HEX NUT 0.5/1M x 13MM - 16PCS ECROU HEXAGONAL 0.5/1M x 13MM - 16 PCS</p>	<p>6</p>  <p>CRESCENT NUT 0.5/1M x 13MM - 16 PCS ECROU CROISSANT 0.5/1M x 13MM - 16 PCS</p>
<p>7</p>  <p>7A 7B MINIFIX 8.5MM x 15MM 7 PCS SET MINIFIX 8.5MM x 15MM 7PCS ENSEMBLE</p>	<p>8</p>  <p>JCBB BOLT M8 x 60MM - 6PCS BOULAN JCBC M6 x 60MM - 6 PCS</p>	<p>9</p>  <p>ADJUSTABLE LEG M6 x 18MM-6PCS REGLABLE M6x 18MM - 6 PCS</p>
<p>10</p>  <p>PANHEAD SCREW M4 x 25MM 20 PCS VIS À TÊTE CYLINDRIQUE -20 PCS</p>	<p>11</p>  <p>WOOD DOWEL M10 x 40MM - 14 pcs CHEVILLE EN BOIS M10 x 40MM 14 PCS</p>	<p>12</p>  <p>ALLEN KEY M4 - 1 PC CLE ALLEN M4 - 1 PC</p>
<p>13</p>  <p>ALLEN KEY M5 - 1 PC CLE ALLEN M5 - 1PC</p>	<p>14</p>  <p>SPANNER - 1PC CLE - 1 PC</p>	<p>15</p>  <p>BARREL NUT - 2 PCS ECROU DE BARIL - 2 PCS</p>





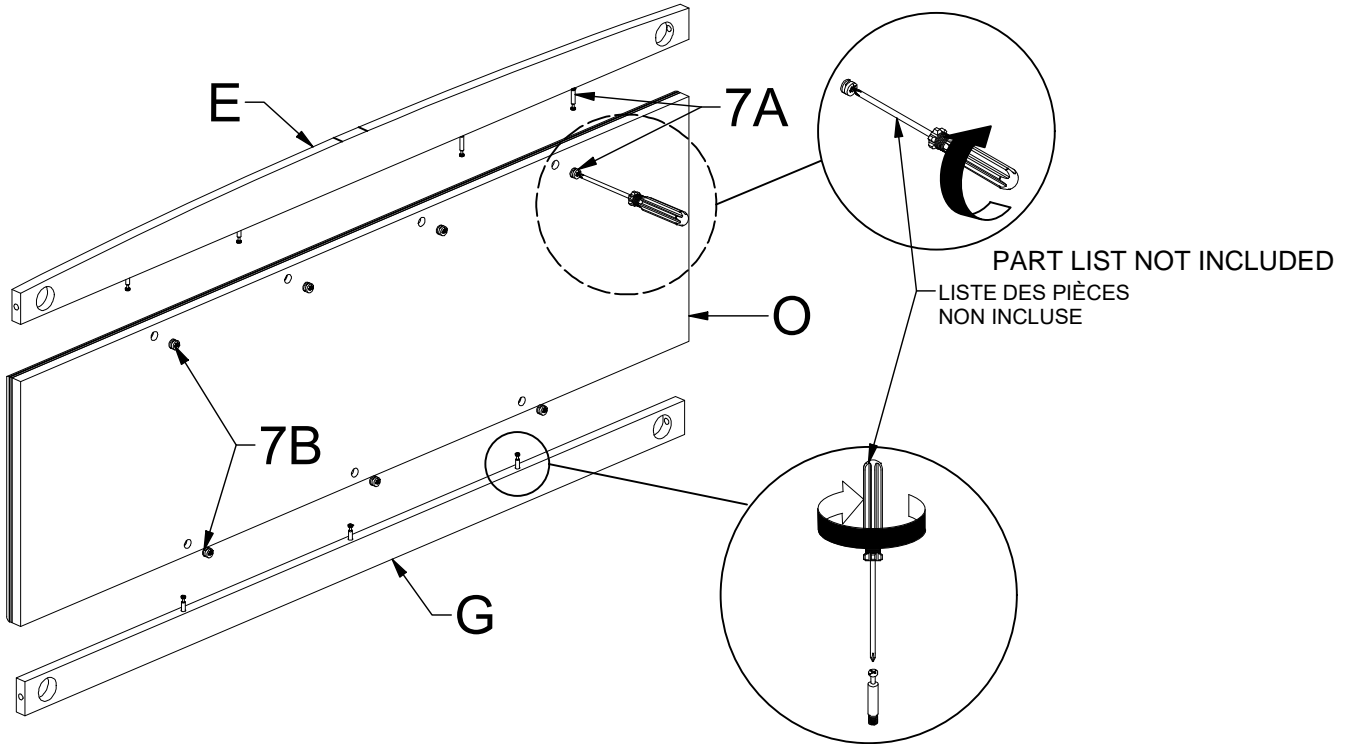

ASSEMBLY INSTRUCTION INSTRUCTIONS DE MONTAGE

STEP 1 ÉTAPE 1

7B	7A
	
7 PCS	7 PCS



STEP 2 ÉTAPE 2



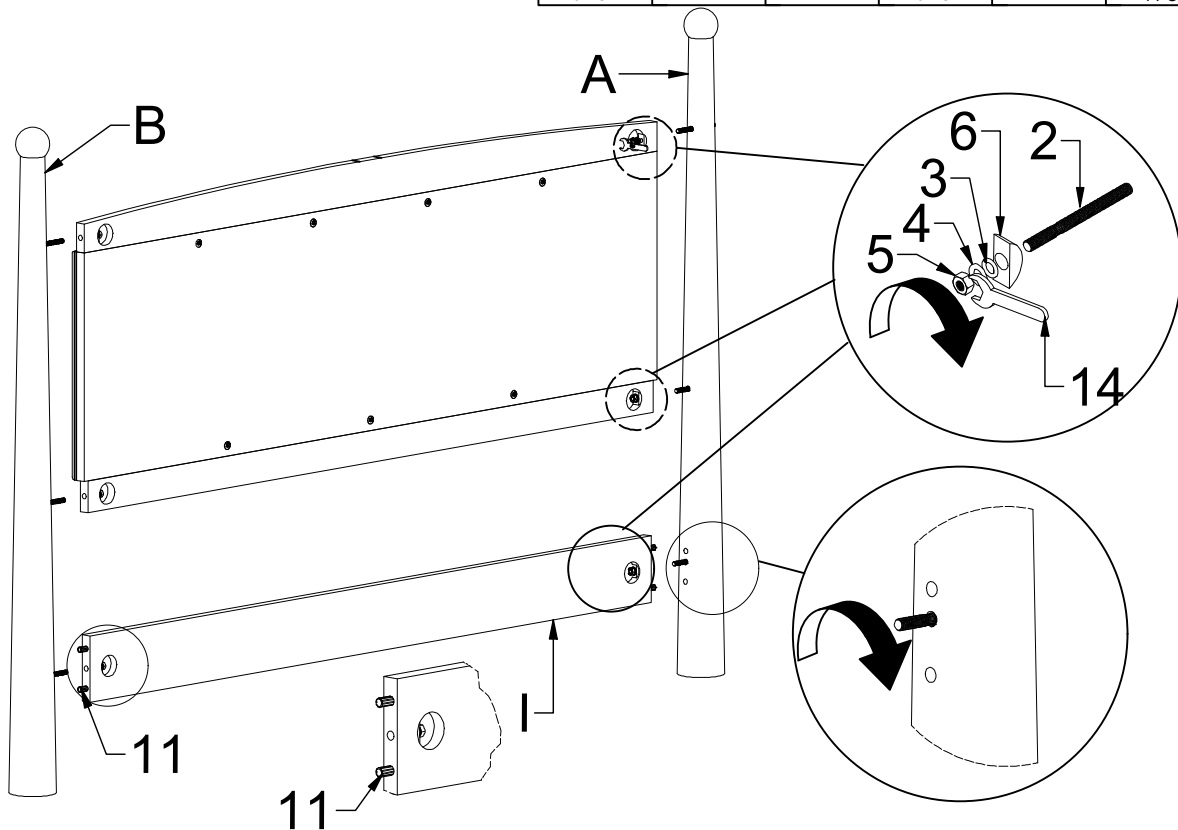







5	3	4	6	2	14	11
						
6 PCS	6 PCS	6 PCS	6 PCS	6 PCS	1 PC	4 PCS



ASSEMBLY INSTRUCTION





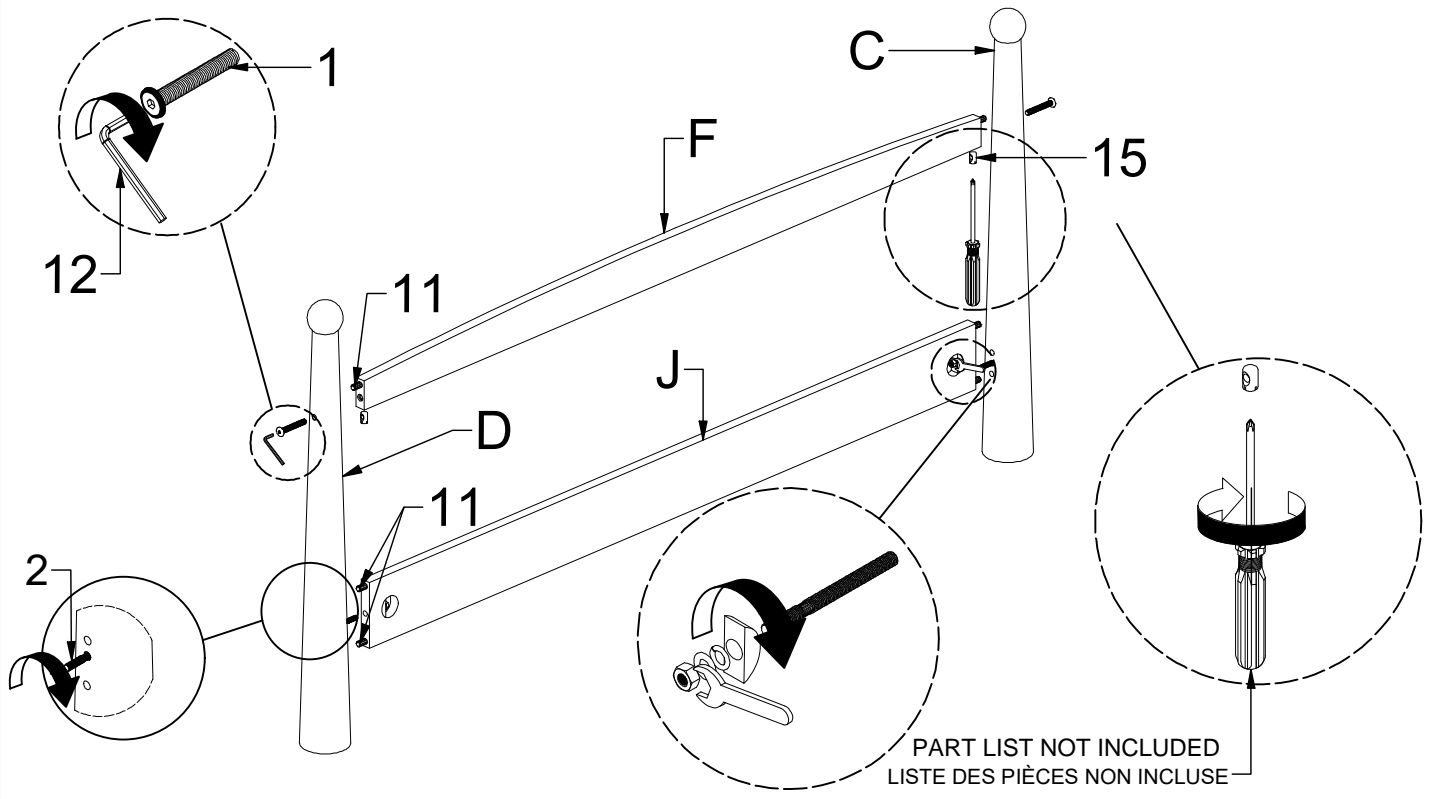

INSTRUCTIONS DE MONTAGE

STEP 3 ÉTAPE 3

5	3	4	6	2	14	12	1	15	11
									
2 PCS	2 PCS	2 PCS	2 PCS	2 PCS	1 PC	1 PC	2 PCS	2 PCS	4 PCS



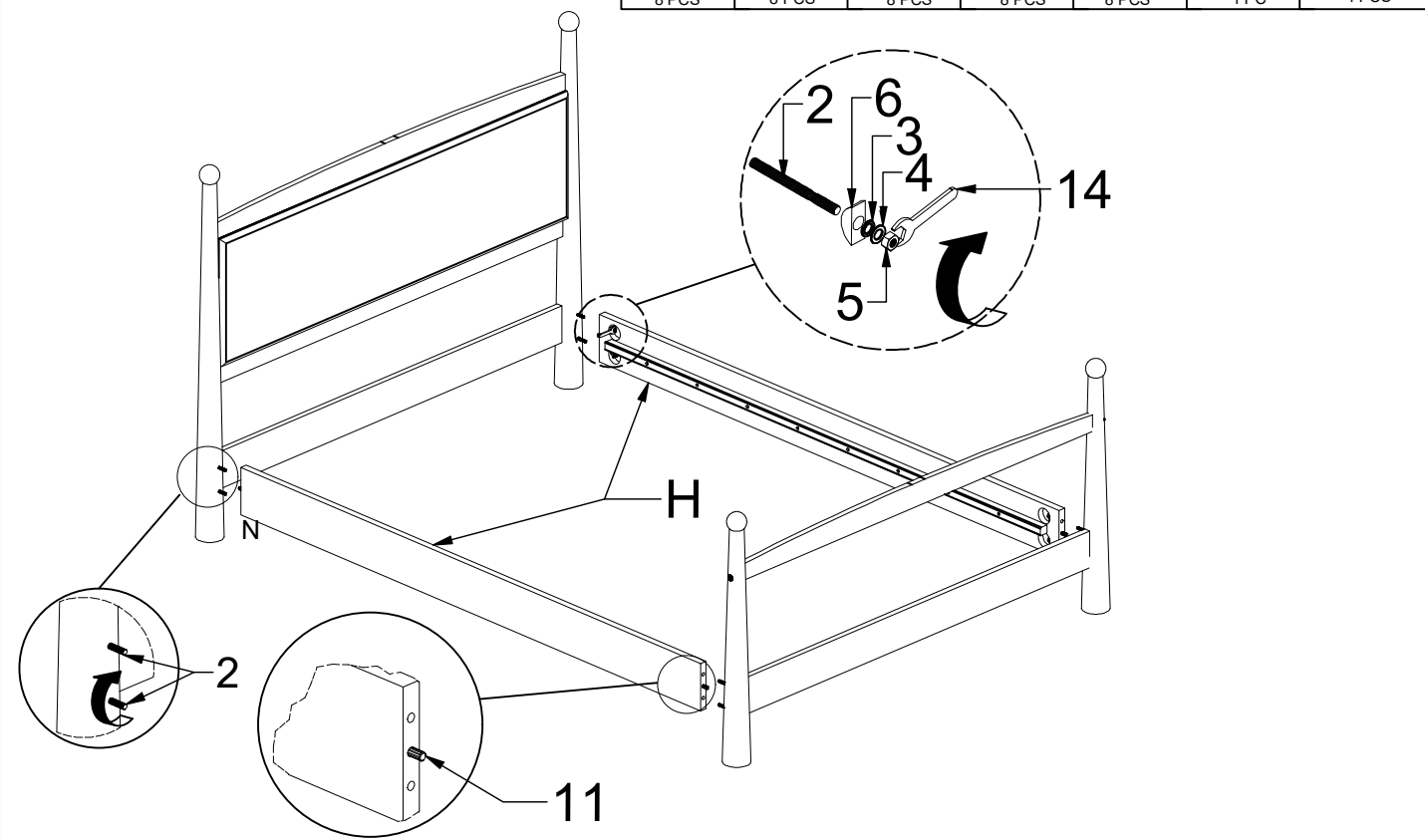

STEP 4 ÉTAPE 4

5	3	4	6	2	14	11
						
8 PCS	8 PCS	8 PCS	8 PCS	8 PCS	1 PC	4 PCS



ASSEMBLY INSTRUCTION INSTRUCTIONS DE MONTAGE

STEP 5 ÉTAPE 5

8	13	9
		
6 PCS	1 PC	6 PCS

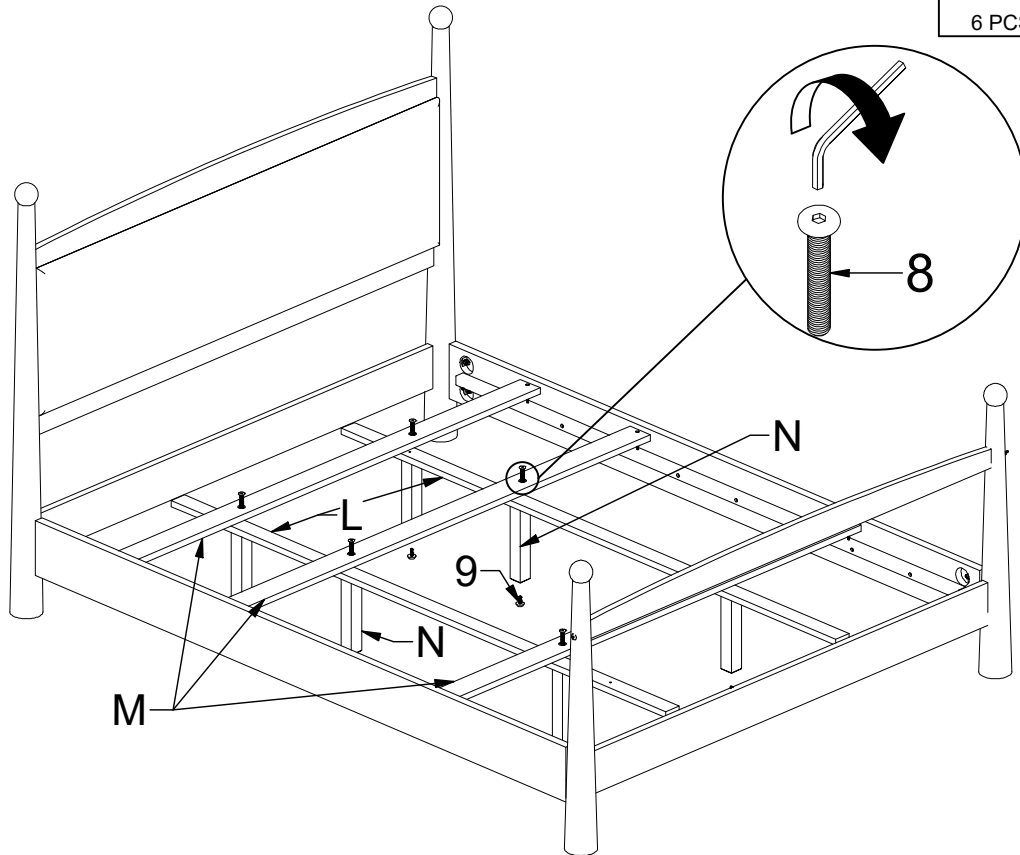

STEP 6 ÉTAPE 6

10

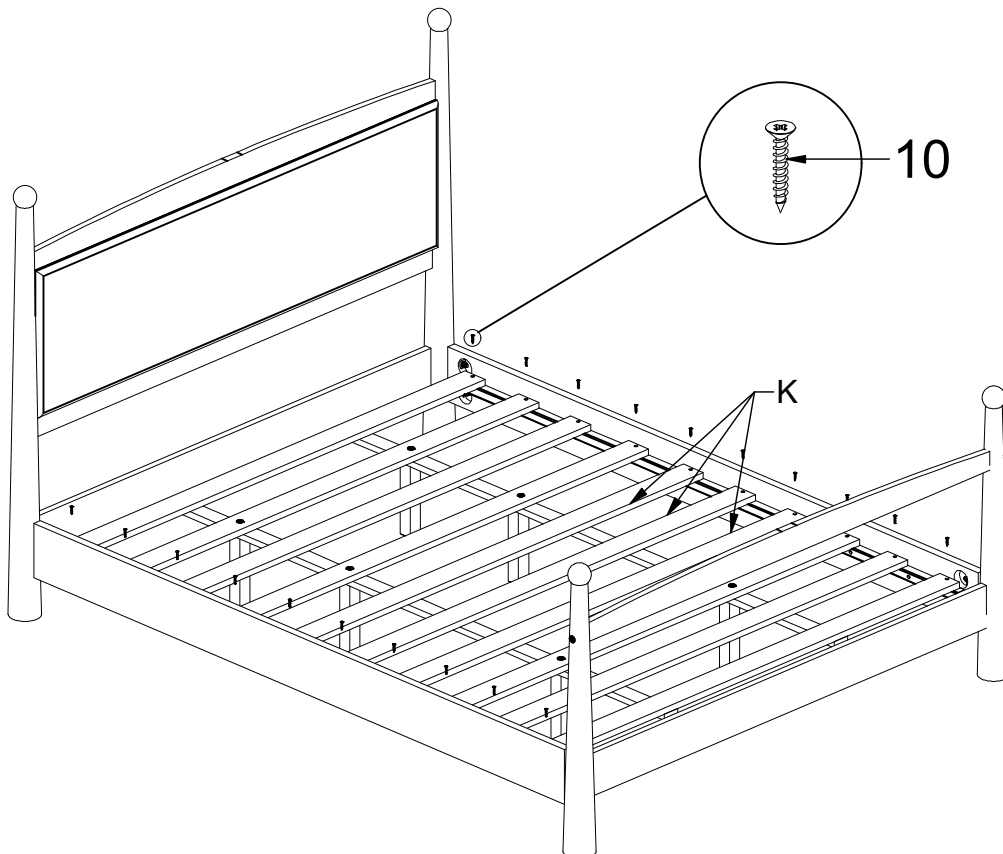
20 PCS



ASSEMBLY INSTRUCTION INSTRUCTIONS DE MONTAGE

COMPLETE
COMPLÈTE

