

Assembly Instructions

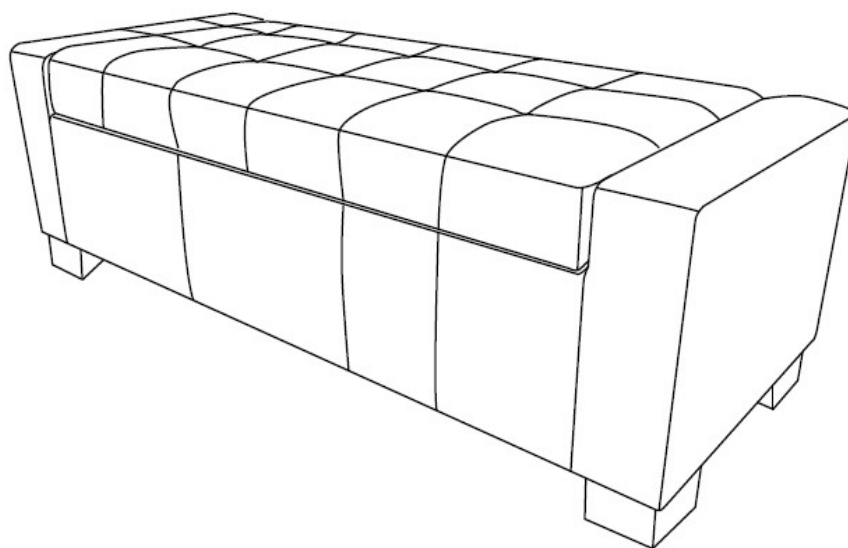

Caution : You must read this before you proceed

Please look in the velcro pouch for hardware packs and legs

Ottoman



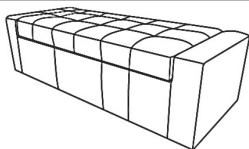

Parts List

Label	Picture	Description	QTY
A		Ottoman	1
B		Leg	4

Hardware List





Label	Picture	Description	QTY
①		Flat Washer	5

②		Spring Washer	5
③		Bolt (M8X60mm)	5
④		Allen Key	1

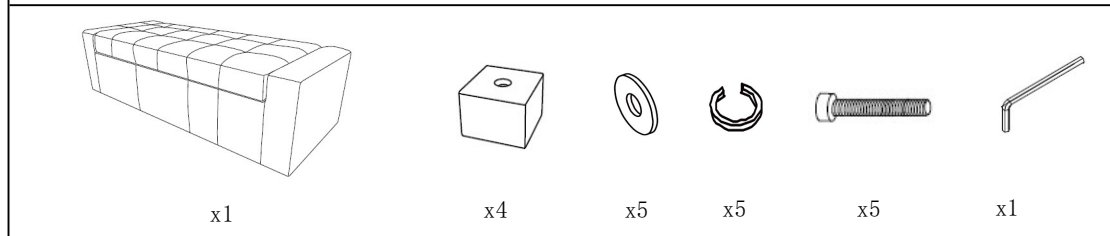
Assembly Preparation

Before Beginning Assembly:



-  • Read instructions, cover to cover-
-  • Have 2 adults on hand for assembly-
-  • Do not assemble on flooring or carpet-
-  • Assemble on a clean non-marring surface (packing foam)-
-  • Save all packaging until finished-

Assembly Steps

Overview

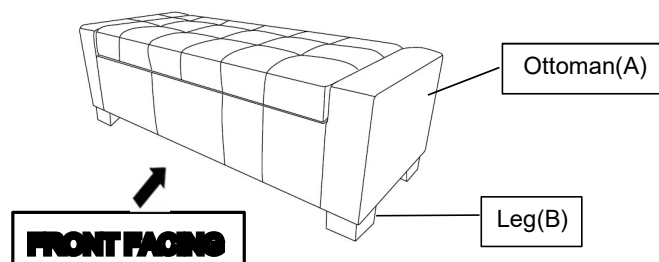

This Ottoman has multiple parts and may require up to 30 minutes to assemble. To give you an overview of the Ottoman parts, the above picture is to help you put the various parts into perspective. Please read through the instructions below to familiarise yourself with the parts and steps before assembly.

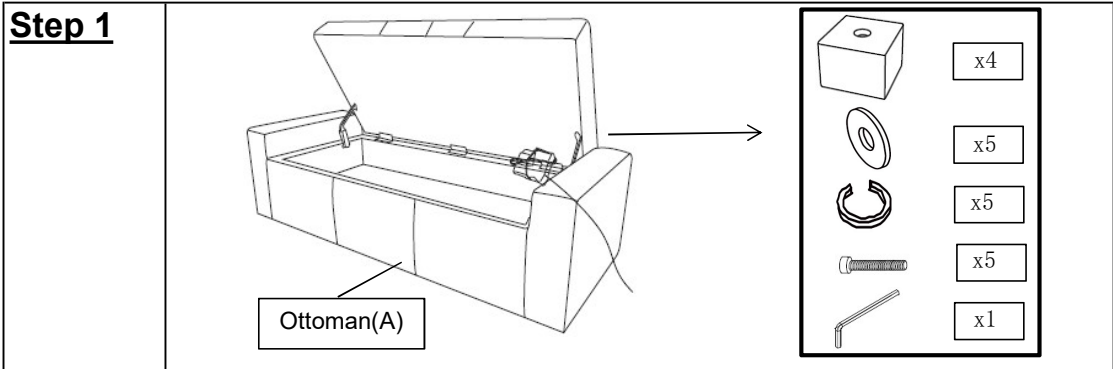

Position the Ottoman(A) on its side on a clean, non-marring surface. Open the Ottoman(A) and remove the four Legs(B) and Hardware package. Then Close the pouch before assembling.

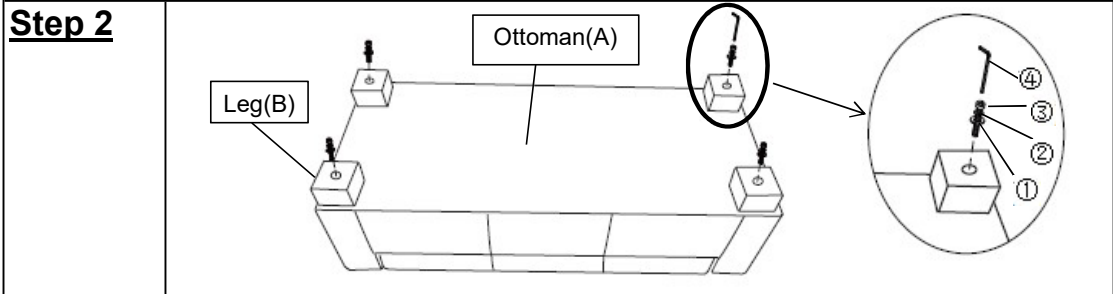



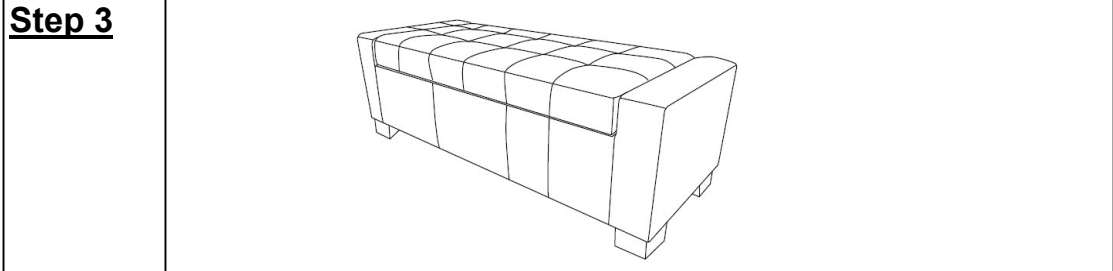







With Assistance from your adult partner, position the Ottoman(A) facedown on a clean, non-marring surface, as shown. Install the Leg(B) to the bottom of Ottoman(A) use Bolts (③), Flat Washer(①), Spring Washer(②) with Allen Key(④). Repeat the same steps to install the remaining 3 legs. Tighten all the bolts by Allen Key(④).



Your Ottoman is ready for use.
Your Ottoman can only be used on a flat, level surface.

Care & Maintenance

-  Do not put hot items directly on furniture surface
 -  Do not clean furniture with harsh cleansers or polish.
 -  Do not place furniture under direct sunlight.
 -  Do not place furniture near heating or cooling vents.
 -  Do not write on furniture without a padded barrier to protect the surface.
 -  Do not place furniture outside . For indoor use only .
 -  Not for commercial use. For residential use only .
 -  Stains may be removed with mild soap solution and damp cloth.
 -  Children should not climb or jump on the furniture.
-
-  Dust and pick-up spills using a clean, non-colored, lint-free cloth .