

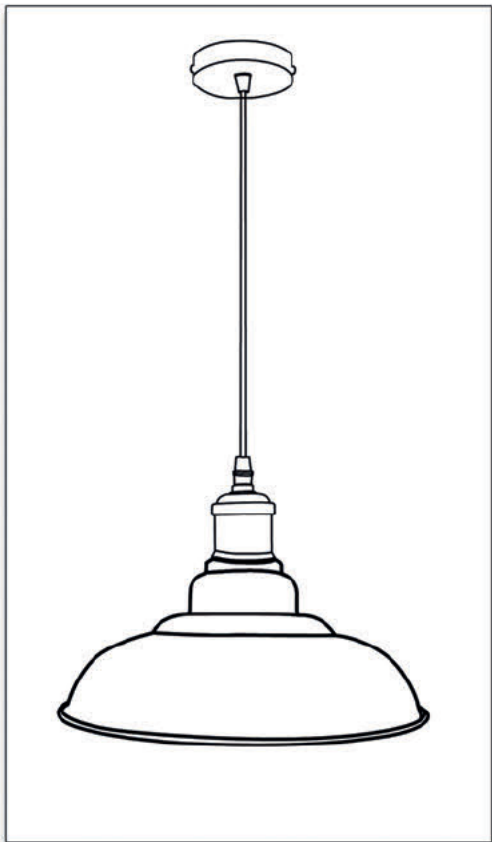

# Vintage Metal Pendant Lamp Assembling Instruction









G  1X Ceiling Rose

H  1X Lamp Shade

I  X Holder With Cable

J  1 X Shade Cap

- A  → 2 x Nice Thread
- B  → 2 x Wall plugs
- C  → 2 x Screw
- D1  → 1 x Cord grip
- D2  → 1 x Cord grip
- E  → 1 x Connector
- F  → 1 x Ceiling Bracket





RoHS



# Pendant Lamp

## Assembling instruction

1

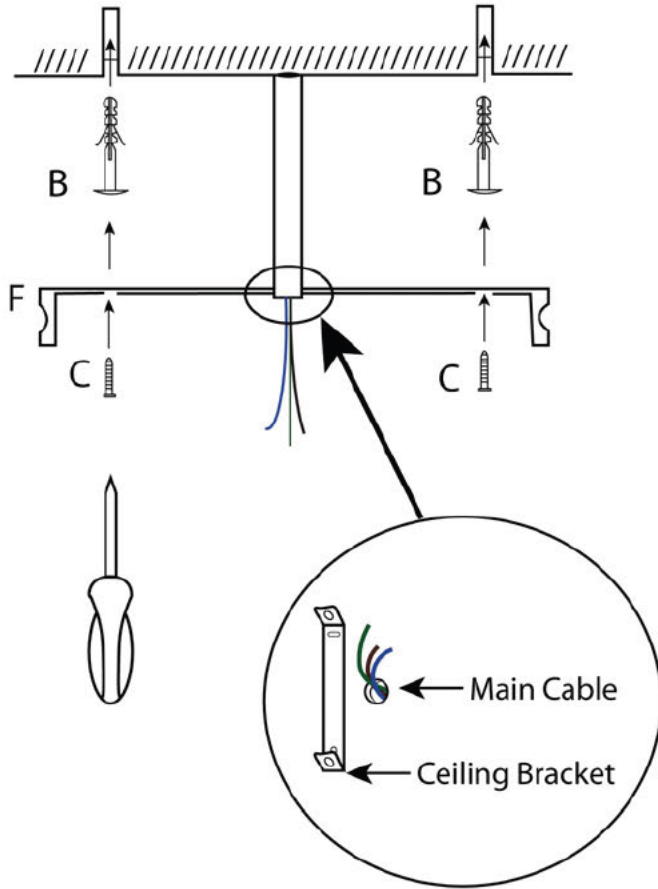

The cable should come next to the bracket

2



3

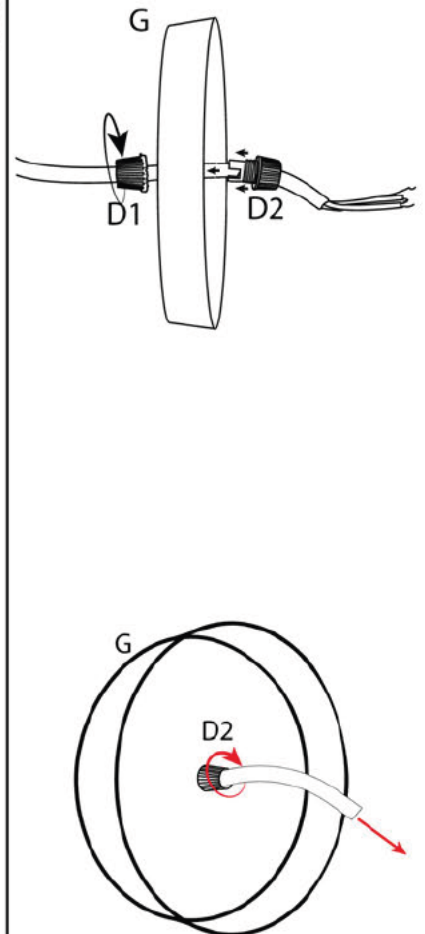

4

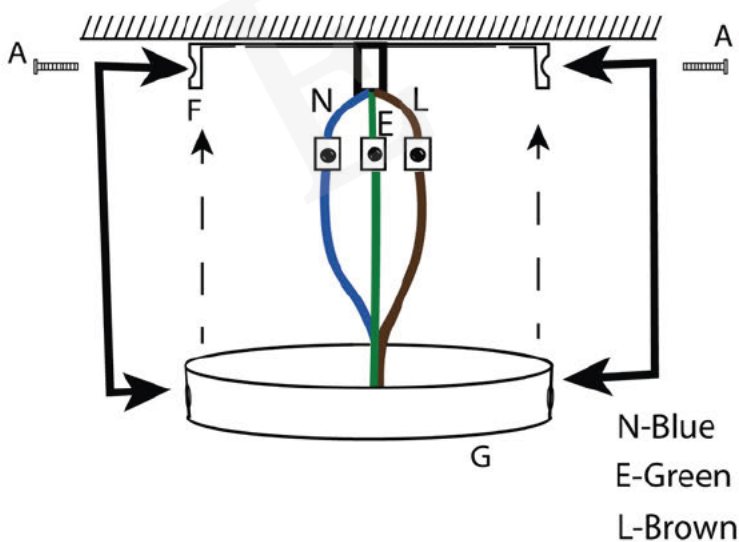

N-Blue  
E-Green  
L-Brown

5

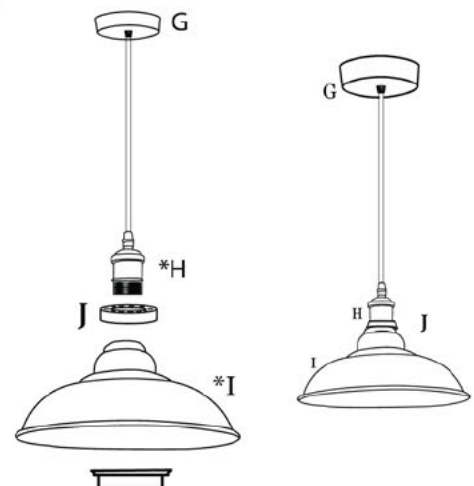

\* Please refer the last page for compatible lamp shades & pendant holders



RoHS



# Compatible

# Pendant and Lamp shades

Pendant Holder With Cable

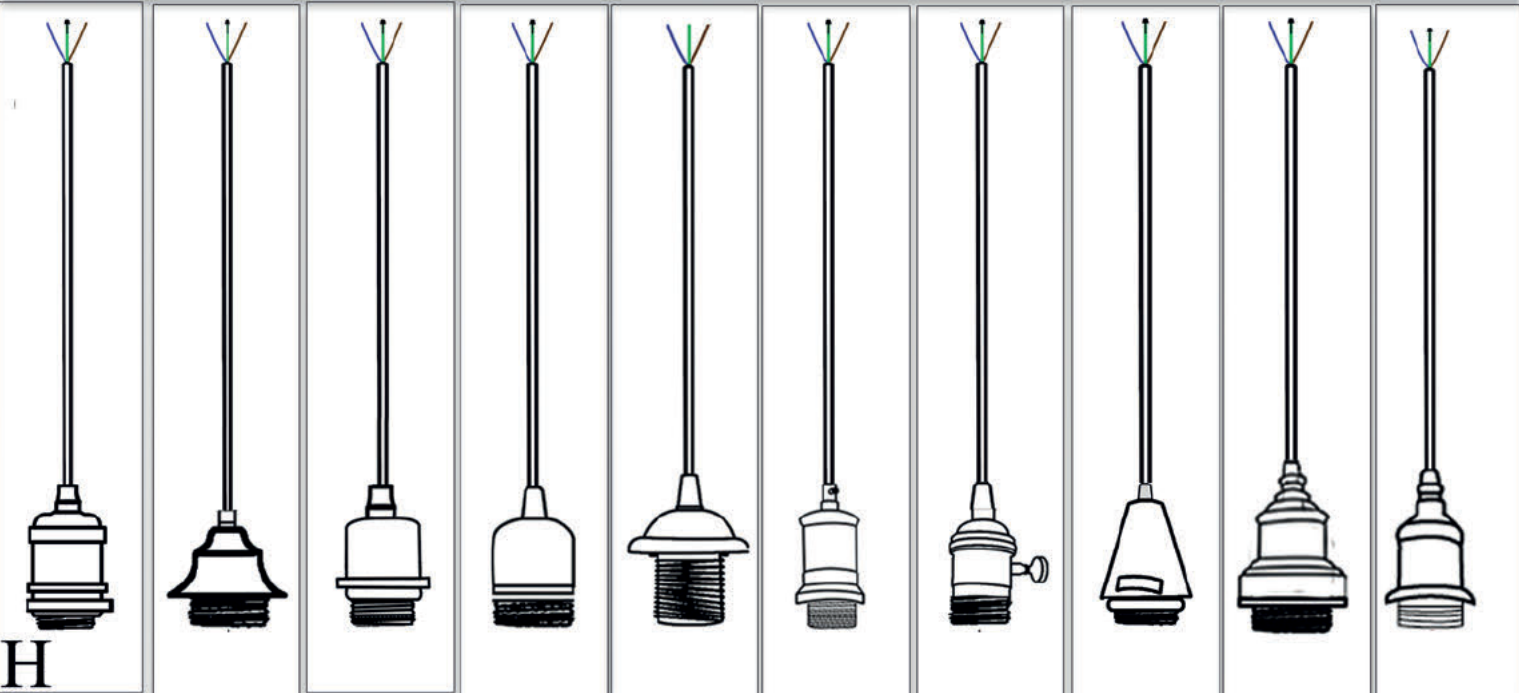

H

Pendant Lamp Shades

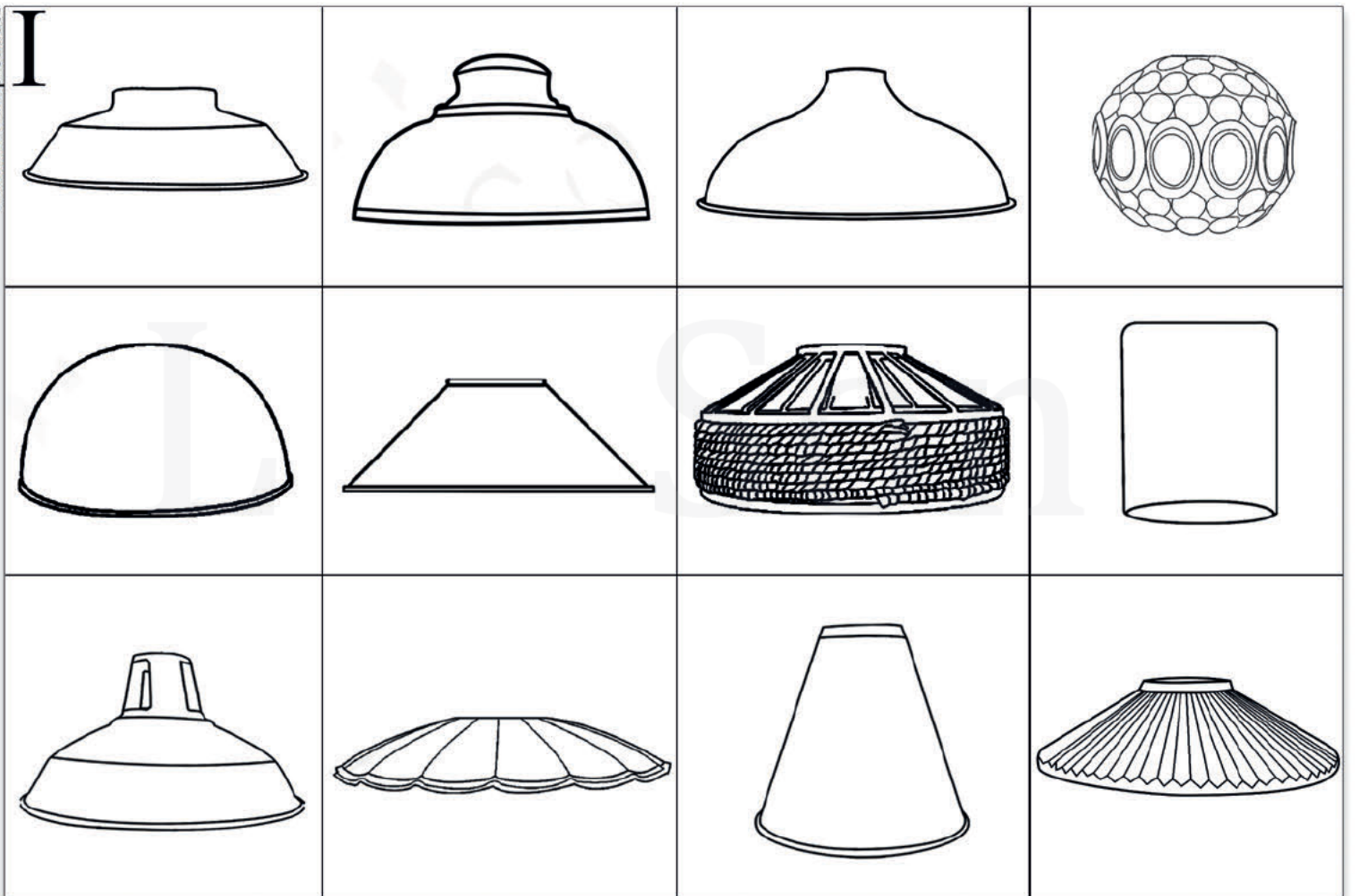

I