

# FRAMED LED MIRROR

With Front and Backlit

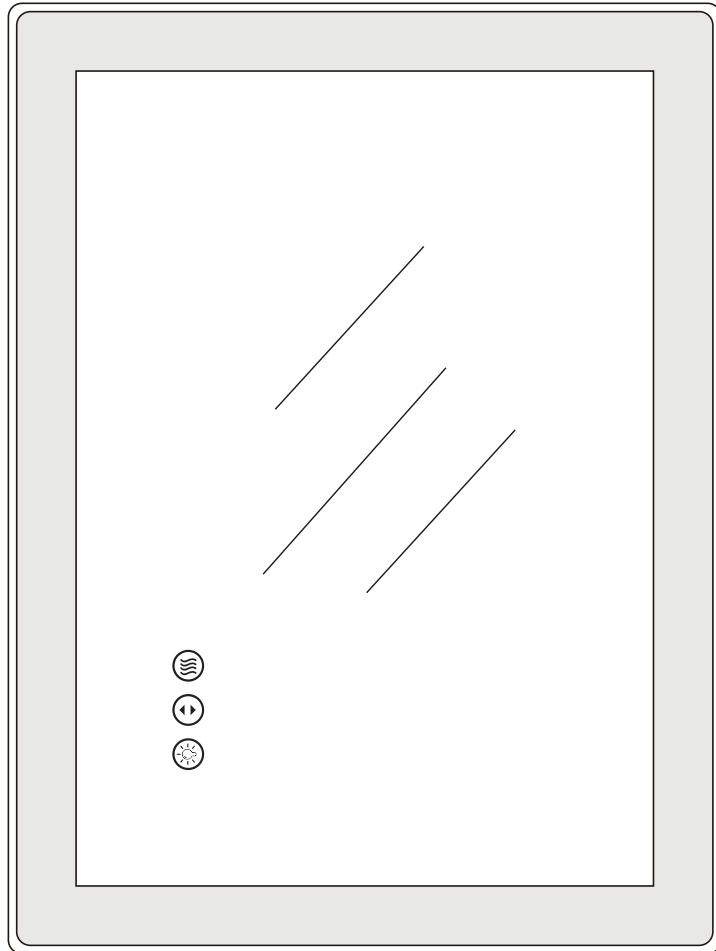

## User Manual

### Before Installation

**Thank you so much for choosing our mirrors, in order to facilitate the use of our products, please read this instruction carefully before installation.**

#### **Please Notice:**

1. Please read all instructions carefully before assembling the item.
2. After opening the package, inspect the product immediately upon receipt for transit damage or missing parts.
3. Please power the mirror with plug to test all its functions before installing on the wall.
4. Assembly by two or more adults is highly recommended.
5. Disconnect power before installing, adding or changing any components.
6. Ensure that the fixing location is able to take the weight of the complete fitting.
7. Keep the voltages 110V-120V. If the voltage exceeds 120V, please use transformer.
8. To connect the wires to electrical junction box, a qualified technician or electrician is highly recommended.

**Please check and make sure below functions work properly before installation** Ⓣ

# Product Functions

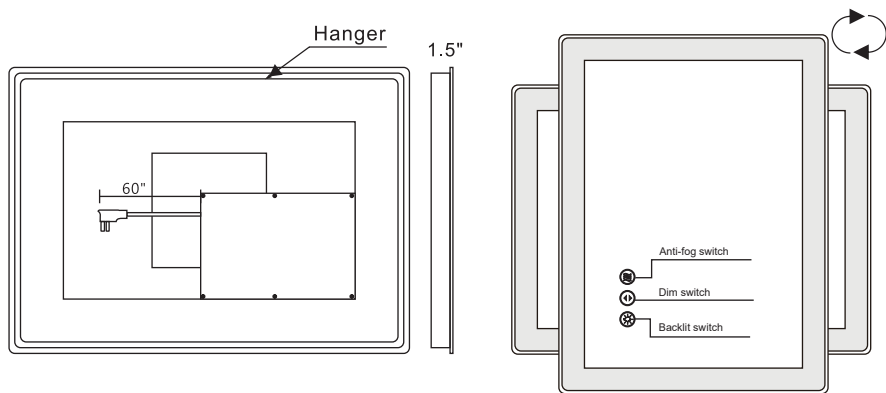

Horizontal/ Vertical Installation



**Anti-fog switch:** After connecting the power, the anti-fog function is already turn on automatically. If you don't need to use it, just touch it to turn it off, to prevent wasting energy. The defogging will take effect within 10 minutes after it's turned on and close in 1 hour, so you can turn it on 10 minutes before taking a bath.



**Dim switch:** The led light supports 10% to 100% brightness adjustment, just long press the button. This button has memory function, the next time you open the mirror it will be in the same brightness it was in before it was last closed, which means that you don't have to touch the buttons each time.



**Color temperature switch:** The front and back lights all have three color temperatures that can be switch(3000K/4000K/6000K), just need to short press this button. And this button has a memory function as well.

# Button Lighting Mode

State of Button Light	Meaning
White Light ON	Function is Working
Blue Light ON	Function Standby
Light OFF	Power OFF

# Package Contents

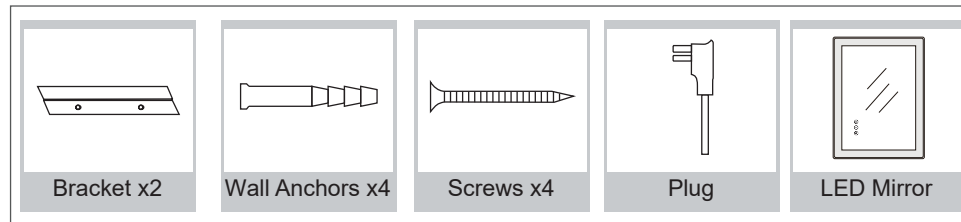

# Installation tools you may need

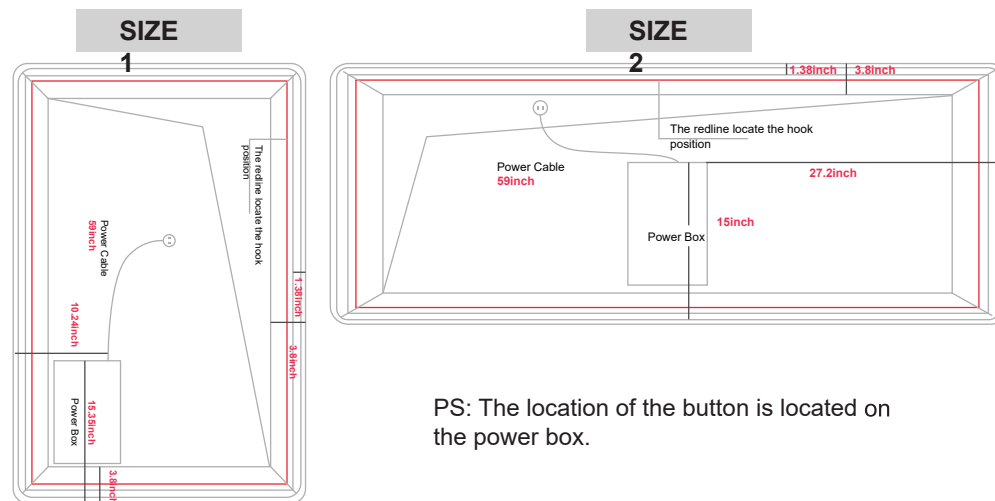
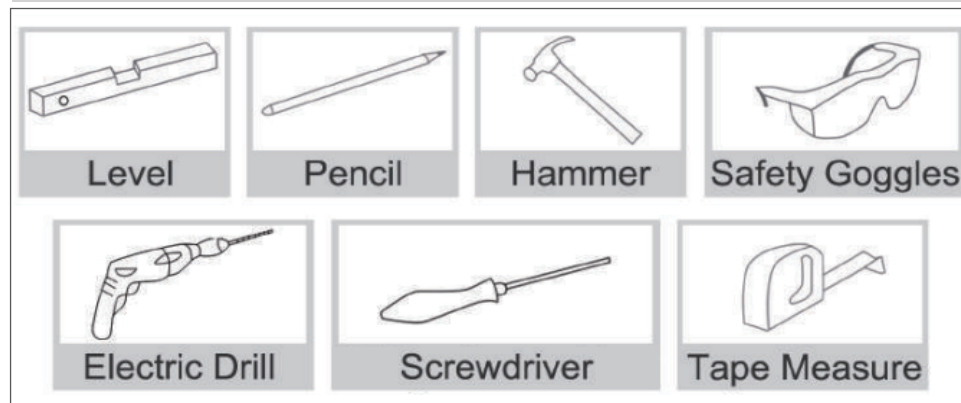

PS: The location of the button is located on the power box.

# Product Specifications

Size	Thickness	Touch Button	LED Strip Mode	Color Temperature	Lumen	CRI	Life Span	Power (W)	Input Voltage(V)	Output Voltage(V)	Weight (LB)
28" X "20	1.33"	3	2835 3 colors 192LED	3000k/4000k /6000k	4093	≥90 Ra	≥50000 hours	36	110V, 50/60HZ	24V	13.6
32" X "24	1.33"	3	2835 3 colors 192LED	3000k/4000k /6000k	5067	≥90 Ra	≥50000 hours	36	110V, 50/60HZ	24V	17.4
36" X "24	1.33"	3	2835 3 colors 192LED	3000k/4000k /6000k	5554	≥90 Ra	≥50000 hours	36	110V, 50/60HZ	24V	19
36" X "28	1.33"	3	2835 3 colors 192LED	3000k/4000k /6000k	6042	≥90 Ra	≥50000 hours	36	110V, 50/60HZ	24V	20.3
36" X "30	1.33"	3	2835 3 colors 192LED	3000k/4000k /6000k	6334	≥90 Ra	≥50000 hours	36	110V, 50/60HZ	24V	23.1
36" X "32	1.33"	3	2835 3 colors 192LED	3000k/4000k /6000k	6529	≥90 Ra	≥50000 hours	36	110V, 50/60HZ	24V	24.3
36" X "36	1.33"	3	2835 3 colors 192LED	3000k/4000k /6000k	7016	≥90 Ra	≥50000 hours	48	110V, 50/60HZ	24V	26.5
38" X "38	1.33"	3	2835 3 colors 192LED	3000k/4000k /6000k	7601	≥90 Ra	≥50000 hours	48	110V, 50/60HZ	24V	29.7
40" X "24	1.33"	3	2835 3 colors 192LED	3000k/4000k /6000k	6042	≥90 Ra	≥50000 hours	36	110V, 50/60HZ	24V	21
40" X "30	1.33"	3	2835 3 colors 192LED	3000k/4000k /6000k	6821	≥90 Ra	≥50000 hours	48	110V, 50/60HZ	24V	25.6
40" X "32	1.33"	3	2835 3 colors 192LED	3000k/4000k /6000k	7016	≥90 Ra	≥50000 hours	48	110V, 50/60HZ	24V	26.5
40" X "36	1.33"	3	2835 3 colors 192LED	3000k/4000k /6000k	7503	≥90 Ra	≥50000 hours	48	110V, 50/60HZ	24V	29.7
48" X "30	1.33"	3	2835 3 colors 192LED	3000k/4000k /6000k	7796	≥90 Ra	≥50000 hours	48	110V, 50/60HZ	24V	32.6
48" X "32	1.33"	3	2835 3 colors 192LED	3000k/4000k /6000k	7990	≥90 Ra	≥50000 hours	48	110V, 50/60HZ	24V	36.2
48" X "36	1.33"	3	2835 3 colors 192LED	3000k/4000k /6000k	8575	≥90 Ra	≥50000 hours	48	110V, 50/60HZ	24V	33.9
48" X "40	1.33"	3	2835 3 colors 192LED	3000k/4000k /6000k	8965	≥90 Ra	≥50000 hours	60	110V, 50/60HZ	24V	42.3
55" X "30	1.33"	3	2835 3 colors 192LED	3000k/4000k /6000k	8673	≥90 Ra	≥50000 hours	60	110V, 50/60HZ	24V	33.2
55" X "36	1.33"	3	2835 3 colors 192LED	3000k/4000k /6000k	9403	≥90 Ra	≥50000 hours	60	110V, 50/60HZ	24V	40.4
60" X "28	1.33"	3	2835 3 colors 192LED	3000k/4000k /6000k	8965	≥90 Ra	≥50000 hours	60	110V, 50/60HZ	24V	34
60" X "30	1.33"	3	2835 3 colors 192LED	3000k/4000k /6000k	9355	≥90 Ra	≥50000 hours	60	110V, 50/60HZ	24V	43
60" X "36	1.33"	3	2835 3 colors 192LED	3000k/4000k /6000k	9939	≥90 Ra	≥50000 hours	60	110V, 50/60HZ	24V	44.2
60" X "40	1.33"	3	2835 3 colors 192LED	3000k/4000k /6000k	10426	≥90 Ra	≥50000 hours	60	110V, 50/60HZ	24V	50.5
72" X "32	1.33"	3	2835 3 colors 192LED	3000k/4000k /6000k	11011	≥90 Ra	≥50000 hours	80	110V, 50/60HZ	24V	49
72" X "36	1.33"	3	2835 3 colors 192LED	3000k/4000k /6000k	11498	≥90 Ra	≥50000 hours	80	110V, 50/60HZ	24V	50.1
72" X "40	1.33"	3	2835 3 colors 192LED	3000k/4000k /6000k	11937	≥90 Ra	≥50000 hours	80	110V, 50/60HZ	24V	52.9
77" X "36	1.33"	3	2835 3 colors 192LED	3000k/4000k /6000k	12132	≥90 Ra	≥50000 hours	80	110V, 50/60HZ	24V	56.9
84" X "32	1.33"	3	2835 3 colors 192LED	3000k/4000k /6000k	12521	≥90 Ra	≥50000 hours	80	110V, 50/60HZ	24V	59.2
84" X "40	1.33"	3	2835 3 colors 192LED	3000k/4000k /6000k	13495	≥90 Ra	≥50000 hours	80	110V, 50/60HZ	24V	72.6
88" X "38	1.33"	3	2835 3 colors 192LED	3000k/4000k /6000k	13788	≥90 Ra	≥50000 hours	80	110V, 50/60HZ	24V	74.2
96" X "36	1.33"	3	2835 3 colors 192LED	3000k/4000k /6000k	14373	≥90 Ra	≥50000 hours	100	110V, 50/60HZ	24V	88
110" X "40	1.33"	3	2835 3 colors 192LED	3000k/4000k /6000k	16760	≥90 Ra	≥50000 hours	100	110V, 50/60HZ	24V	109.6

# Product Specifications

Parameter	Specification
Switch	Touch Sensor Switch
LED Color Change	Yes
LED Dimming	Yes
Memory	Yes
Anti-fog	Yes
Waterproof	IP54
Safety Compliance	UL
Glass Thickness	5 MM
Glass Material	Tempered Glass
Cable Length	1.5 M
Power Source	Hardwired / Plug in
Mounting Type	Wall Mounted
Mounting Method	French Cleat Mounting
Orientation	Horizontal / Vertical
Warranty	3-Year Manufacturer

# Installation Instruction

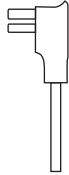
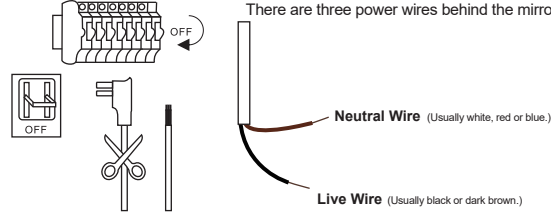
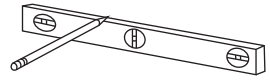
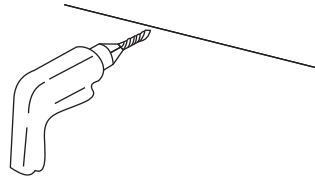
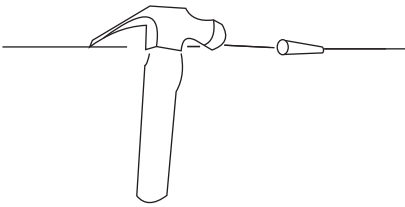
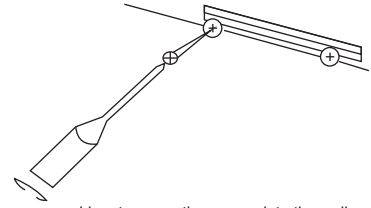
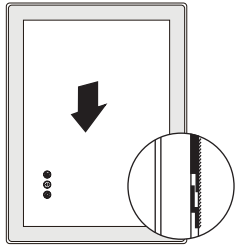
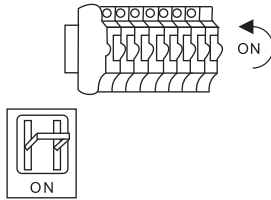
Method 1: Plug in	Method 2: Hardwire
 <p>Insert the plug into the socket, keep the voltages between 110V and 120V. If the voltage exceeds 120V, please use transformer.</p>	 <p>There are three power wires behind the mirror</p> <p>Neutral Wire (Usually white, red or blue.)</p> <p>Live Wire (Usually black or dark brown.)</p> <p>Cut the plug, connect the same color wire and tighten them (Disconnect power before hardwire).</p>
<p>Step 1</p>  <p>Draw a straight line with a ruler to keep the mirror horizontal</p>	<p>Step 2</p>  <p>Use a electric drill to punch four holes at the marked spots.</p>
<p>Step 3</p>  <p>Apply wall anchors with hammer.</p>	<p>Step 4</p>  <p>Use a screwdriver to screw the screws into the wall anchors.</p>
<p>Step 5</p>  <p>Hang the mirror on the wall</p>	<p>Step 6</p>  <p>Turn on the power.</p>

# Troubleshooting

<p>LED doesn't turn on / Defogging doesn't work</p>	<p>Open the power box on the back of the mirror and test the power cables, tighten the cables if they are loose. ( Please cut off the power firstly before testing the power supply and cables).</p>
<p>Part of light strip is fault</p>	<p>Firstly, please pull the outer silicone strip away and press the inner light strip inward. If it still doesn't work, need replace the strip light.</p>
<p>After using for a few month, the light doesn't work.</p>	<p>Please contact us to replace the power supply.</p>

