

# ASSEMBLY INSTRUCTIONS

WF290083/WF2290084

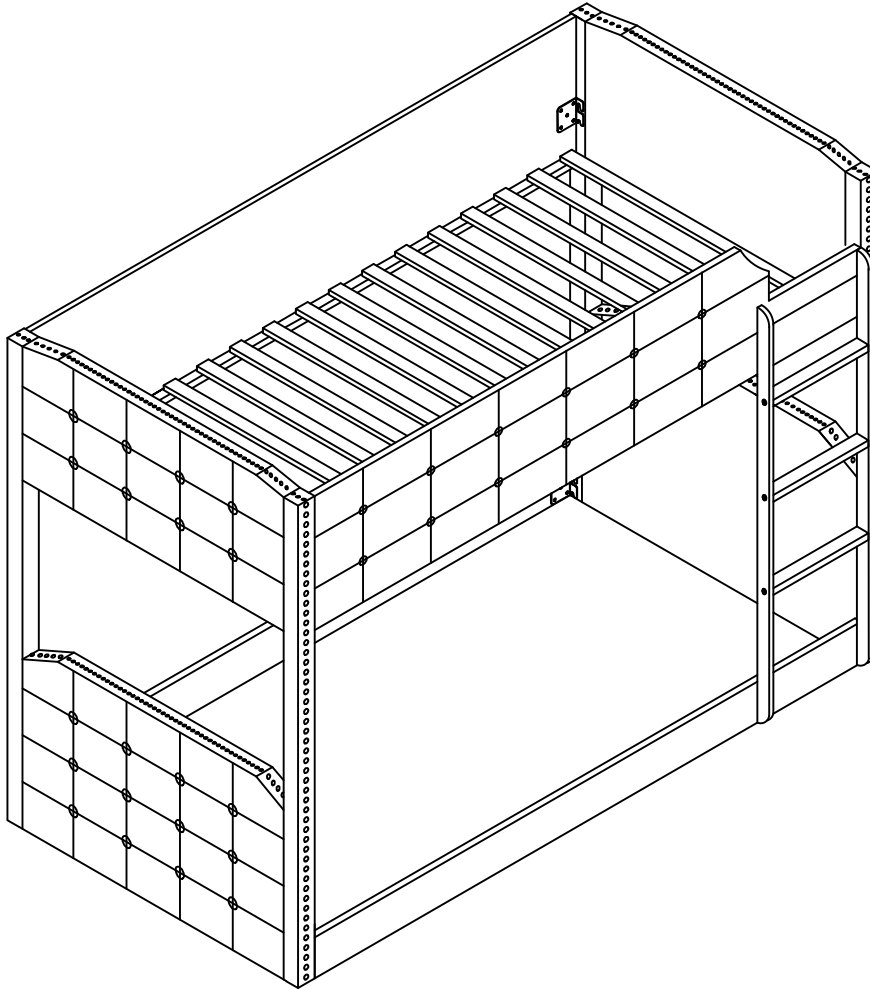

## IMPORTANT NOTE

**\*\*PLACE ALL PARTS ON A CLEAN AND SMOOTH SURFACE SUCH AS A RUG OR CARPET TO  
AVOID THE PARTS FROM BEING SCRATCHED**

**\*\* BEFORE YOU BEGIN , KINDY FOLLOW THE ASSEMBLY INSTRUCTIONS STEP BY STEP**

**\*\*DO NOT TIGHTEN ALL SCREWS AND BOLTS UNTIL THE BED IS FULLY SET-UP**

## SAFETY WARNINGS AND GENERAL NOTES:

Follow the information on the warnings on the bunk bed end structure and on the carton. Do not remove the warning label from the bed. Always use the recommended size mattress on mattress support, or both, to help prevent the likelihood of entrapment or falls.

Do not allow children under 6 years of age to use the upper bunk.

Periodically check and ensure the guardrail, ladder and other components are in their proper position, free from damage, and all connectors are tight.

Do not allow horseplay on or under beds.

Always prohibit jumping on the bed.

Prohibit more than one person on upper bunk.

Always use the ladder for entering and leaving the upper bunk.

Do not use substitute parts. Contact the manufacturer or dealer for replacement parts.

Use of a night-tight may provide added safety precaution for a child using the upper bunk.

Always use guardrails on both long sides of the upper bunk.

If the bunk bed will be placed next to a wall, the guardrail that runs the full length of the bed should be placed against the wall to prevent entrapment between the bed and the wall.

The use of water or sleep flotation mattresses is prohibited.

STRANGULATION HAZARD- Never attach or hang item to any part of the bunk bed that are not designed for use with the bed.

Keep these instructions for future reference.

We recommend assembling your bunk bed on the shipping carton to protect your floor or carpet .

Be certain all staples are out of the box before beginning assembly on the shipping carton.

USE ONLY MATTRESSES WHICH ARE AS THE TABLE BELOW ON UPPER AND ON LOWER BUNKS.

### Down bed

Bed type	Length	Width	Thickness
Twin Standard	74" - 75"	38 <sup>1/2</sup> "	8" max

### Up bed (bunk bed and tribed included)

Bed type	Length	Width	Thickness
Twin Standard	74" - 75"	38 <sup>1/2</sup> "	6" max

SURFACE OF MATTRESS MUST BE AT LEAST 5" (127MM) BELOW THE UPPER EDGE OF GUARDRAILS.

Replacement parts:

Replacement parts, including additional guardrails, may be obtained from any of our (GIGACLOUD TECHNOLOGY (USA) INC.) dealers



# ASSEMBLY INSTRUCTIONS

## WF290083/WF290084

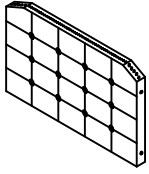
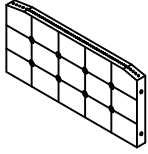
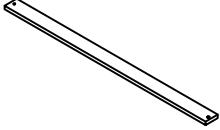



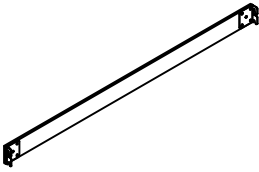
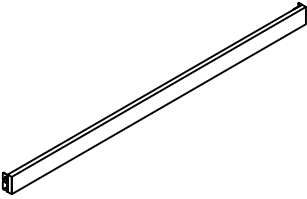
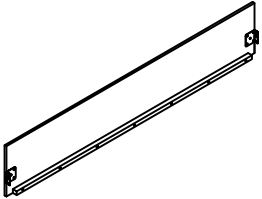
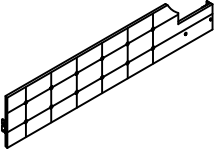
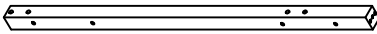

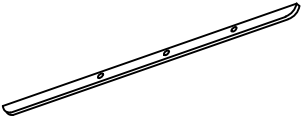
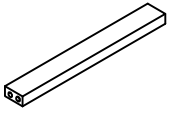
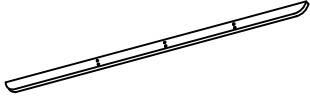
### PARTS LITS BOX 1: WF290083

<p><b>1</b></p>  <p>Lower Bed Panel (2PCS)</p>	<p><b>2</b></p>  <p>Upper Bed Panel (2PCS)</p>	<p><b>3</b></p>  <p>Roll Slat (13PCS)</p>
---	---	--

### PARTS LITS BOX 2: WF290084

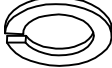
<p><b>4</b></p>  <p>Left Lower Rail (1 pc)</p>	<p><b>5</b></p>  <p>Right Lower Rail (1 pc)</p>	<p><b>6</b></p>  <p>Left Upper Rail (1 pc)</p>
<p><b>7</b></p>  <p>Right Upper Rail (1 pc)</p>	<p><b>8</b></p>  <p>Left Bed Post (2 pcs)</p>	<p><b>9</b></p>  <p>Right Bed Post</p>
<p><b>10</b></p>  <p>Left Stair</p>	<p><b>11</b></p>  <p>Stairs (3 pcs)</p>	<p><b>12</b></p>  <p>Right Stair</p>

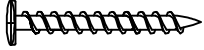



### HARDWARE LIST IN WF290084

<p><b>A</b></p>  <p>(Ø 5/16 "X38mm) Long Bolt (26 pcs)</p>	<p><b>B</b></p>  <p>(M4x75mm x32mm) Allen Wrench (1 pc)</p>	<p><b>C</b></p>  <p>(Ø 5/16 "X25mm) Short Bolt (16 pcs)</p>
<p><b>D</b></p>  <p>(Ø 5/16 "-RBW) Spring Washer (42 pcs)</p>	<p><b>E</b></p>  <p>(Ø 5/16 "-RBW) Flat Washer (42 pcs)</p>	<p><b>F</b></p>  <p>(m4x30mm-RBW) Flat Head Screw (26 pcs)</p>
<p><b>F</b></p>  <p>(Ø 10 X 40MM) Wood dowel (6 pcs)</p>		

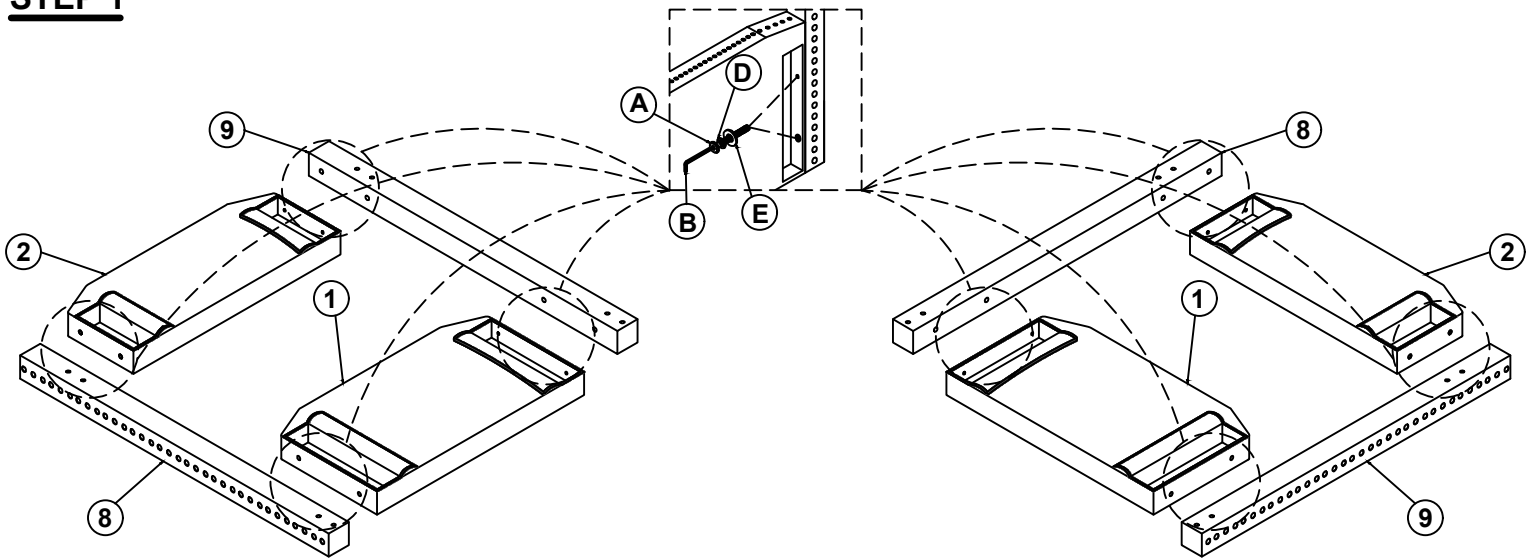
# ASSEMBLY INSTRUCTIONS





## STEP 1

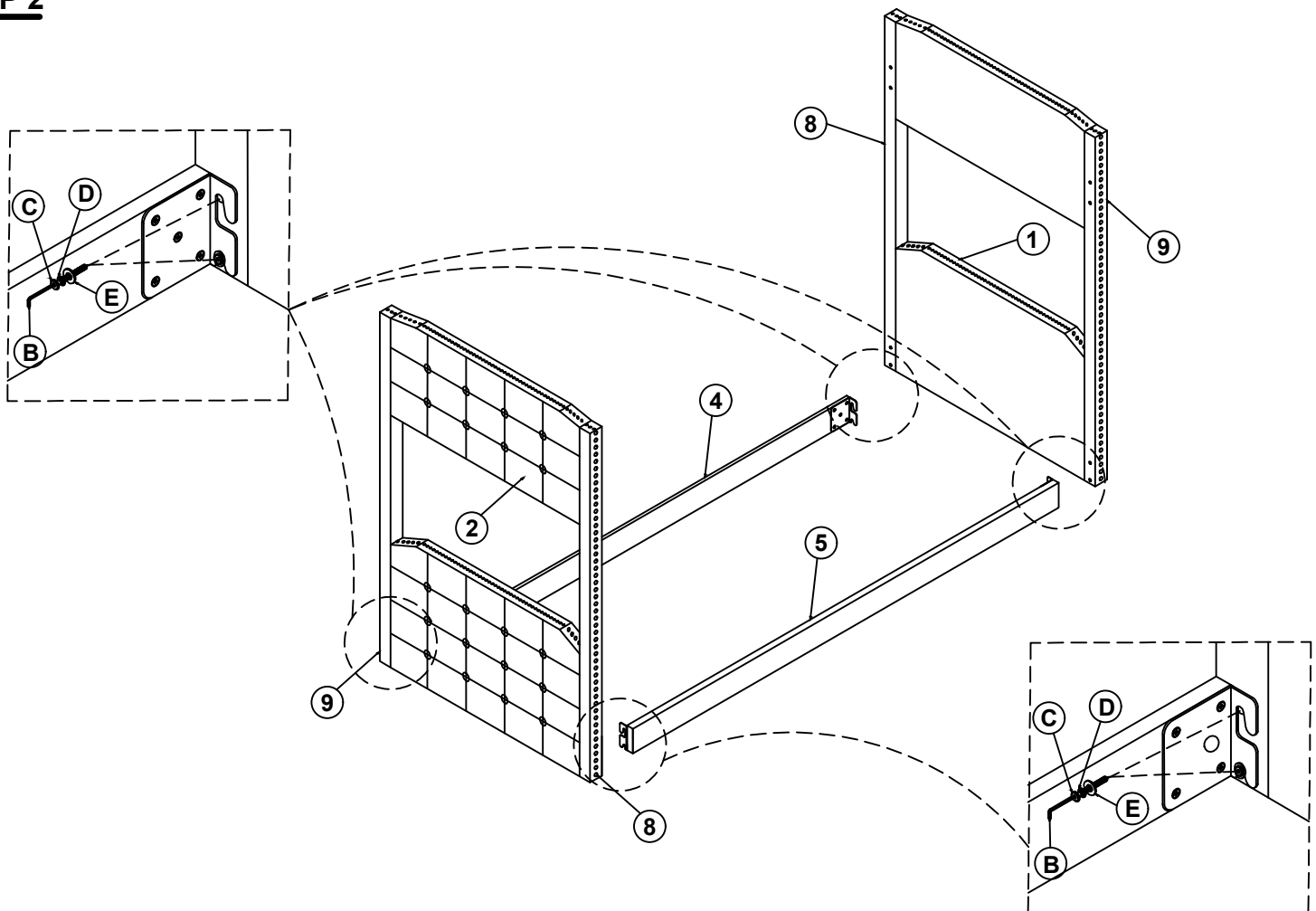

A	<b>Bolt</b> (Ø 5/16 "x38mm)		16pcs	B	<b>Allen Wrench</b> (M4x75mm x32mm)		1pc
D	<b>Spring Washer</b> (Ø 5/16 "-RBW)		16pcs	E	<b>Flat Washer</b> (Ø 5/16 "-RBW)		16pcs

## STEP 2





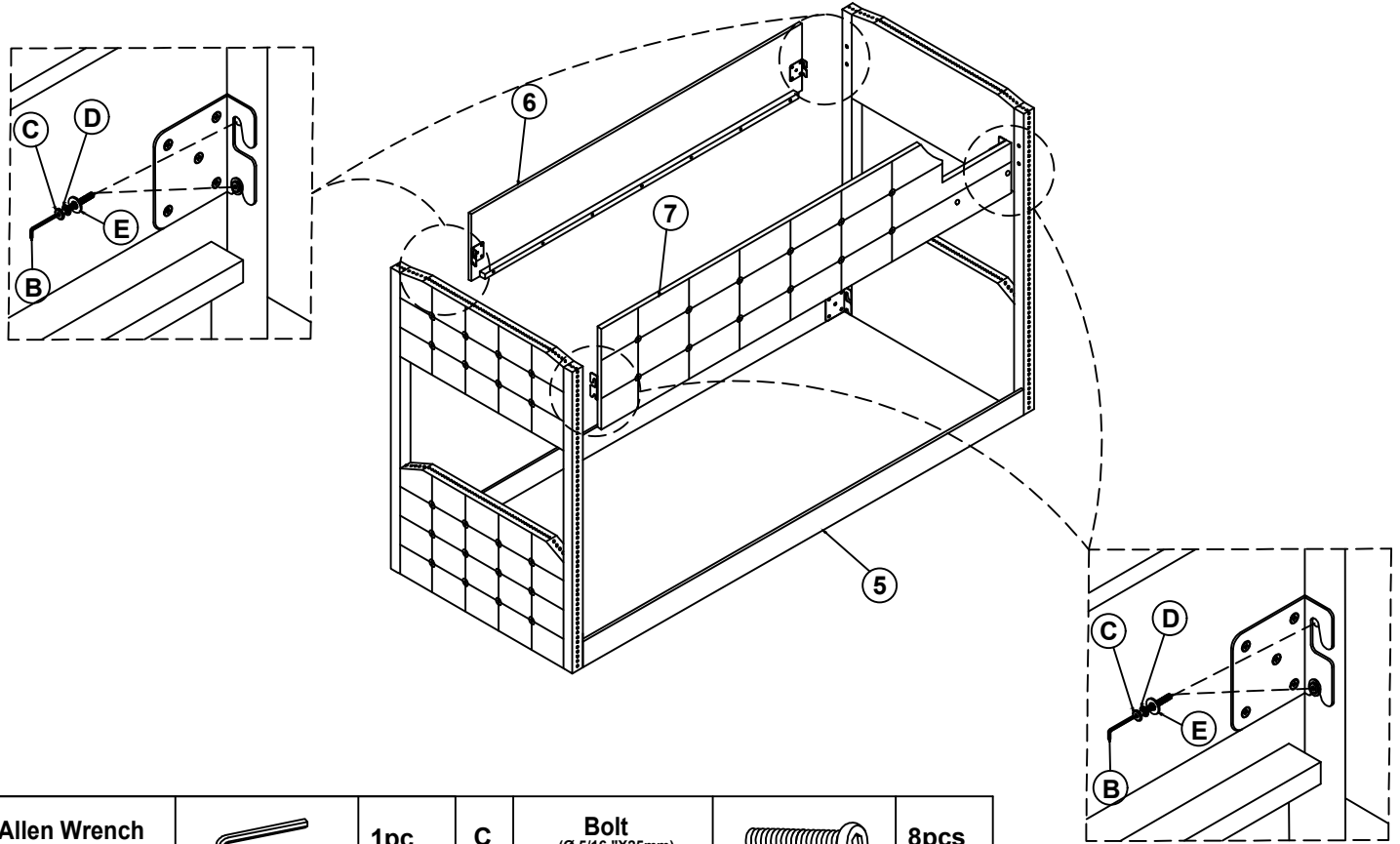

B	<b>Allen Wrench</b> (M4x75mm x32mm)		1pc	C	<b>Bolt</b> (Ø 5/16 "x25mm)		8pcs
D	<b>Spring Washer</b> (Ø 5/16 "-RBW)		8pcs	E	<b>Flat Washer</b> (Ø 5/16 "-RBW)		8pcs

# ASSEMBLY INSTRUCTIONS

## STEP 3



<b>B</b>	<b>Allen Wrench</b> (M4x75mm x32mm)		<b>1pc</b>	<b>C</b>	<b>Bolt</b> (Ø 5/16 "X25mm)		<b>8pcs</b>
<b>D</b>	<b>Spring Washer</b> (Ø 5/16 "-RBW)		<b>8pcs</b>	<b>E</b>	<b>Flat Washer</b> (Ø 5/16 "-RBW)		<b>8pcs</b>

## STEP 4

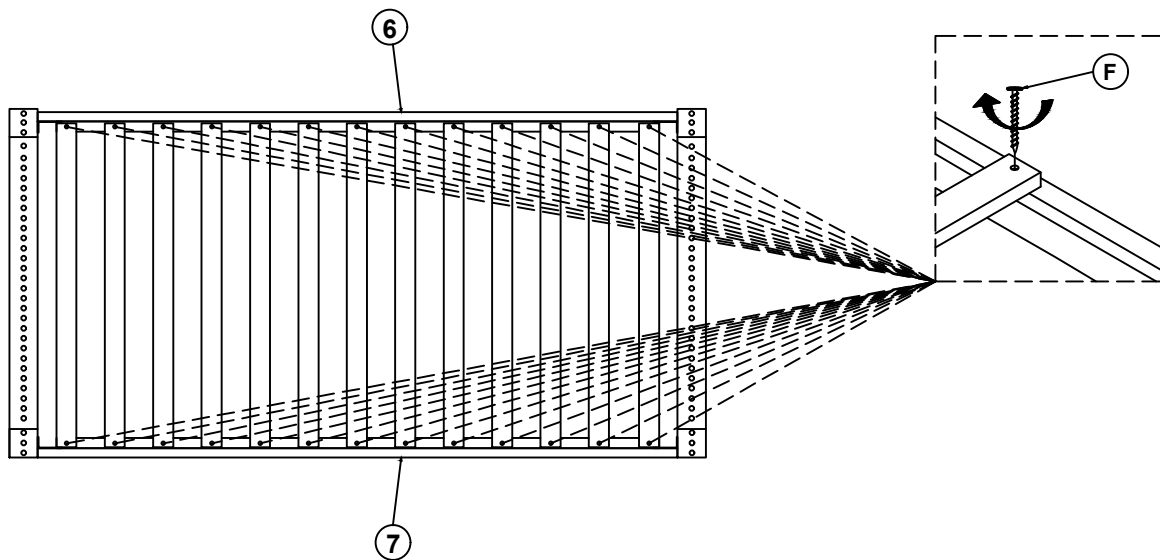

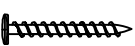

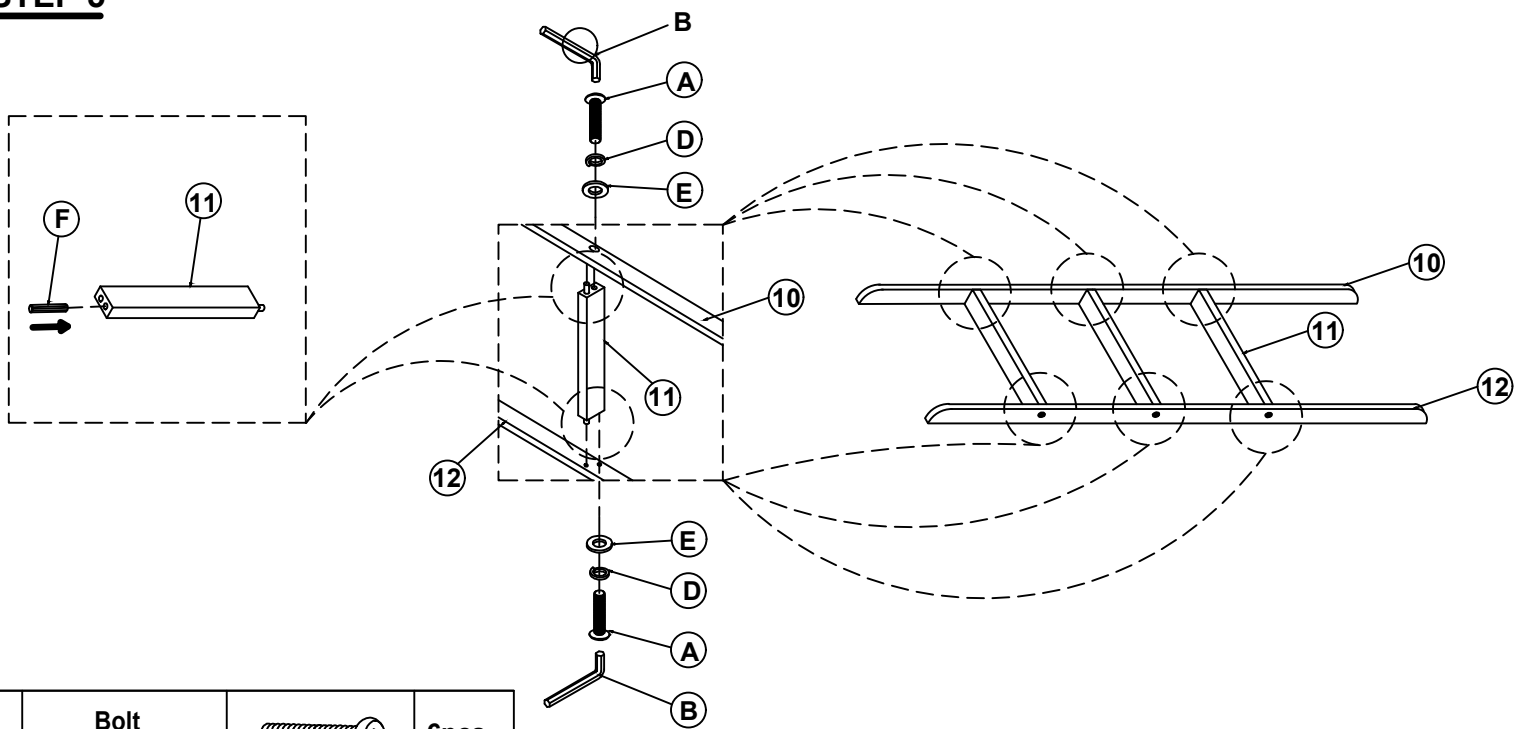

<b>F</b>	<b>Flat Head Screw</b> (m4x30mm-RBW)		<b>26pcs</b>
----------	---	---	--------------

# ASSEMBLY INSTRUCTIONS

## STEP 5





A	<b>Bolt</b> (Ø 5/16 "X38mm)		6pcs
D	<b>Spring Washer</b> (Ø 5/16 "-RBW)		6pcs
E	<b>Flat Washer</b> (Ø 5/16 "-RBW)		6pcs

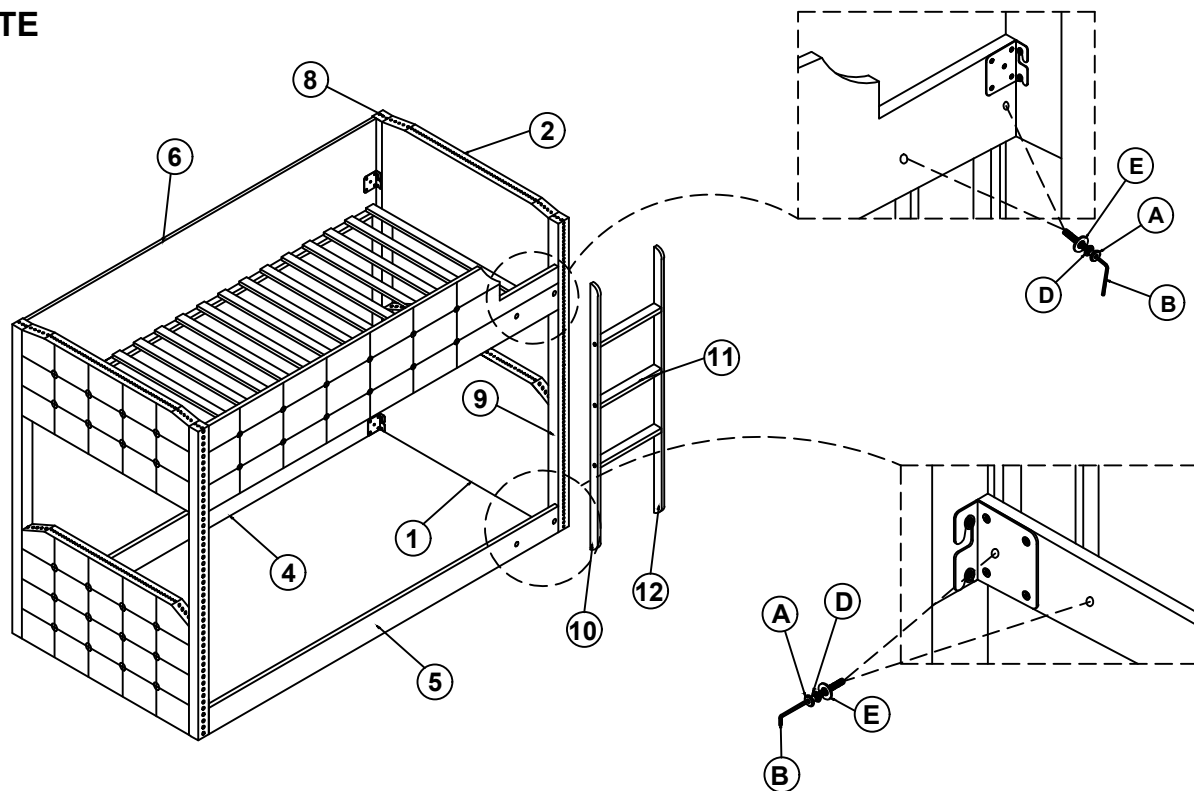

B	<b>Allen Wrench</b> (M4x75mm x32mm)		1pc
F	<b>Wood dowel</b>		6pcs

## STEP 6

### COMPLETE



A	<b>Bolt</b> (Ø 5/16 "X38mm)		4pcs
D	<b>Spring Washer</b> (Ø 5/16 "-RBW)		4pcs

B	<b>Allen Wrench</b> (M4x75mm x32mm)		1pc
E	<b>Flat Washer</b> (Ø 5/16 "-RBW)		4pcs

# ASSEMBLY INSTRUCTIONS

**STEP 7**  
**COMPLETE**

