

# Assembly Instructions

**Caution : You must read this before you proceed**

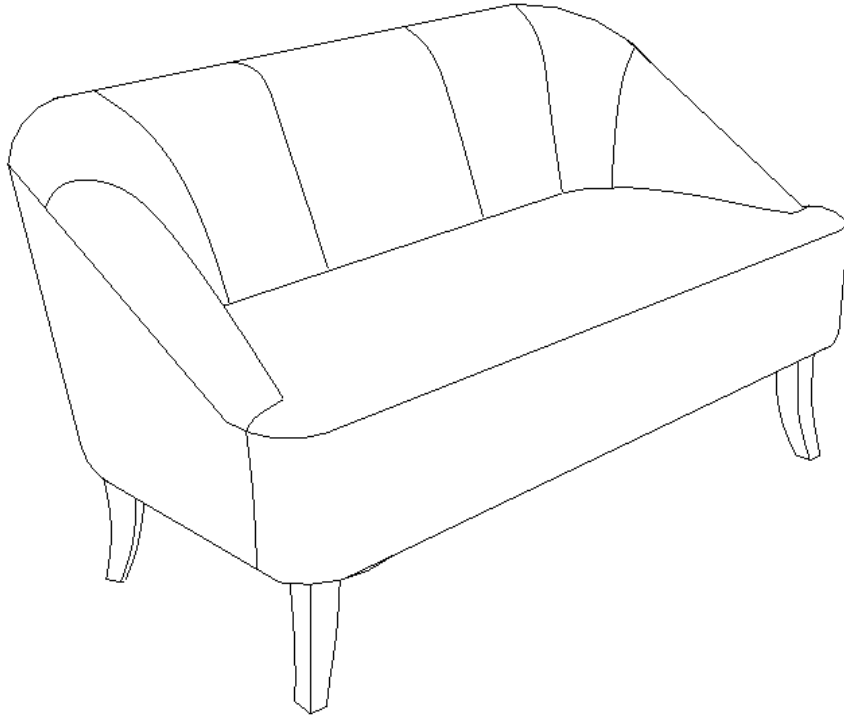



## Loveseat



### Parts List

| Label | Picture  | Description                            | QTY (pc) |
|-------|--|--|----------|
| A     | A line drawing of a single wooden leg with a metal plate positioner at the top. The plate has four circular holes and two rectangular slots.   | Wooden Leg with Metal Plate Positioner | 4        |
| B     | A line drawing of the loveseat base, showing the frame and the attachment points for the legs. There are small circles and crosses on the base indicating where the legs are attached. | Loveseat Base                          | 1        |

# Hardwares List

| Label | Picture   | Description   | QTY (pc) |
|-------|---|---------------|----------|
| ①     |  | Screw         | 13       |
| ②     |  | Allen Key     | 1        |
| ③     |  | Washer Ring   | 13       |
| ④     |  | Spring Washer | 13       |

## Assembly Preparation

Before Beginning Assembly:

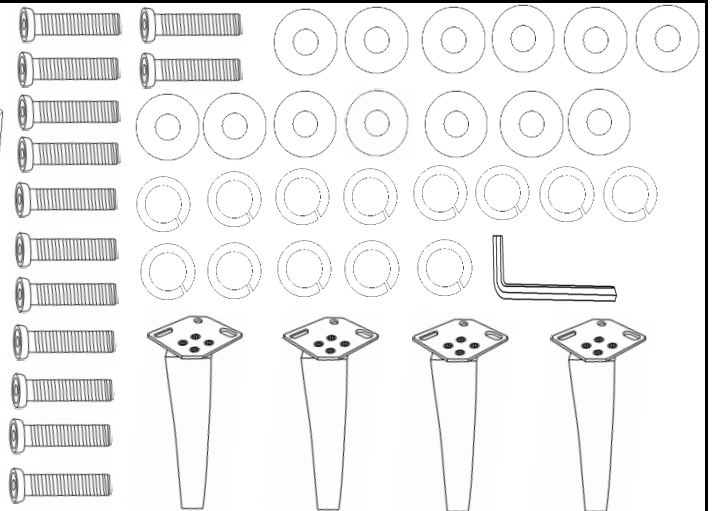
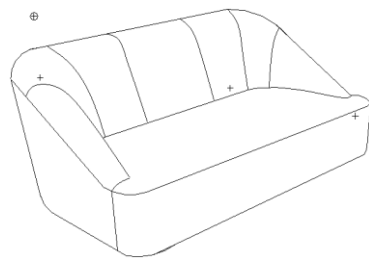

- Read instructions, cover to cover-



- Have 2 adults on hand for assembly-



- Do not assemble on flooring or carpet-



- Assemble on a clean non-marring surface (packing foam)-



- Save all packaging until finished-

# Assembly Steps

Loveseat Base(B)

Wooden Legs with  
Metal Plate  
Positioner(A)

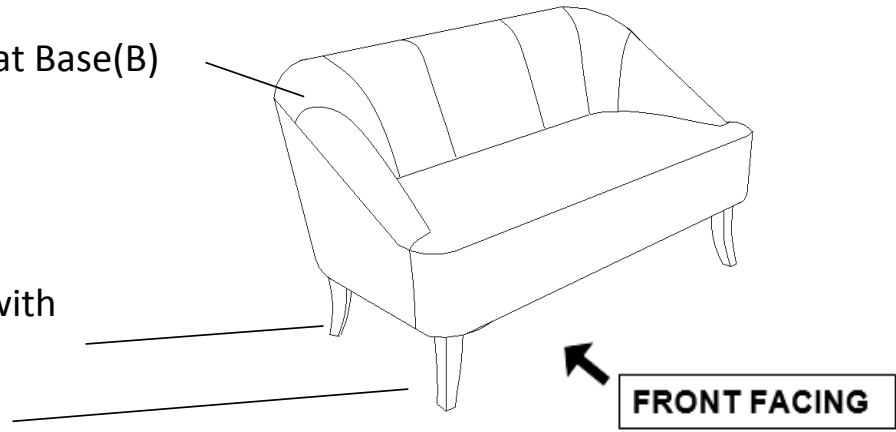

This product has multiple parts and may require up to some 30 minutes to assemble. To give you an overview of the product parts, the above picture is to help you put the various parts into perspective. Please read through the instructions below to familiarise yourself with the parts and steps before assembly.

## Step 1

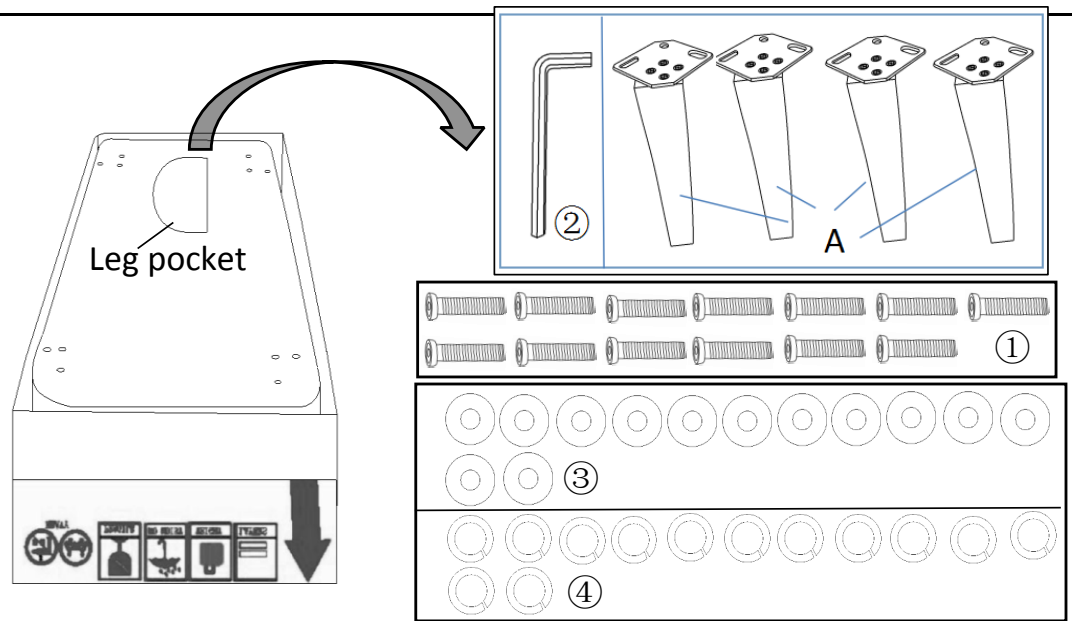

Take the Wooden Legs with Metal Plate Positioner(A),Screws(1),Allen Key(2),Washer Rings(3) and Spring Washers(4) out from the leg pocket at the bottom of Loveseat Base(B).

## Step 2

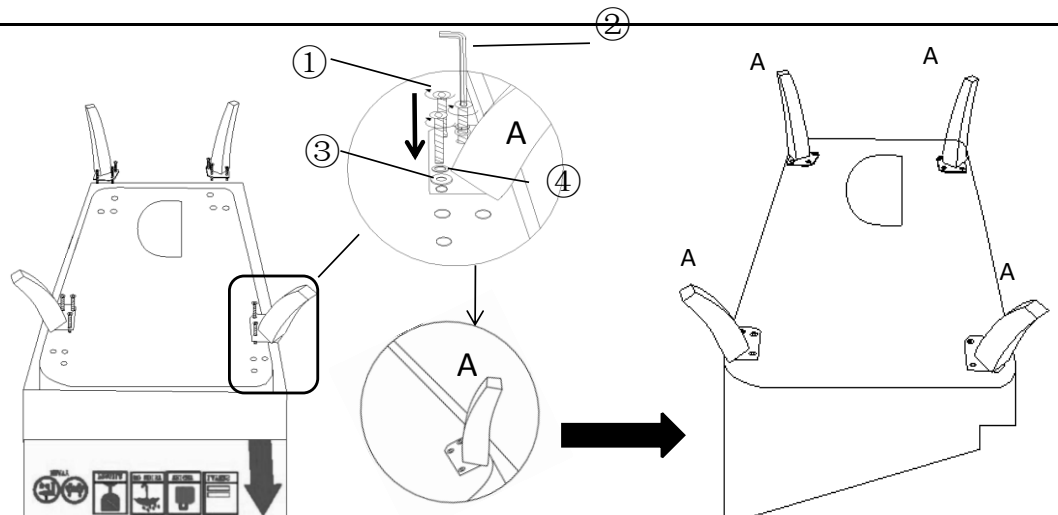

Install the Wooden Legs with Metal Plate Positioner(A)at the bottom of the Loveseat Base(B).Take one Wooden Leg with Metal Plate Positioner(A) and align the 3 holes of the metal Plate Positioner according to the 3 holes at the corner of the Loveseat Base(B),then take 3 Screws(①) by placing one Washer Ring(③) and one Spring Washer(④) on each one, then insert the 3 Screws into the holes.Screws(①) to be tighten by turning the Allen Key(②).

Repeat the same process to install the remaining three Legs.



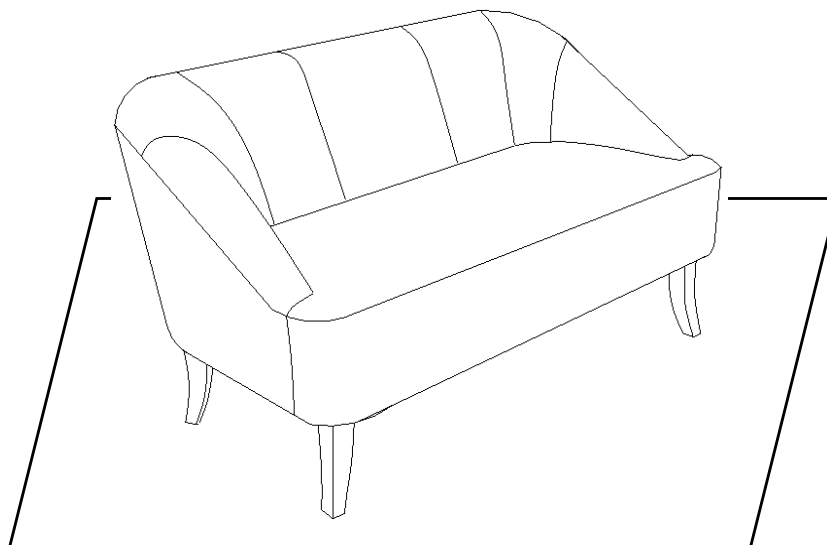















### Step3



Your Loveseat is ready for use.

**This Loveseat can only be used on a flat, level surface.**

## Care & Maintenance

-   ● Do not put hot items directly on furniture surface
-   ● Do not clean furniture with harsh cleansers or polish.
-   ● Do not place furniture under direct sunlight.
-   ● Do not place furniture near heating or cooling vents.
-   ● Do not write on furniture without a padded barrier to protect the surface.
-   ● Do not place furniture outside . For indoor use only .
-   ● Not for commercial use. For residential use only .
-   ● Stains may be removed with mild soap solution and damp cloth.
-   ● Children should not climb or jump on the furniture.

---

### Questions & Answers about Proposition 65

#### • What is Proposition 65?

Proposition 65 requires businesses to provide warnings to Californians about significant exposures to chemicals that cause cancer, birth defects or other reproductive harm. These chemicals can be in the products that Californians purchase, in their homes or workplaces, or that are released into the environment. By requiring that this information be provided, Proposition 65 enables Californians to make informed decisions about their exposures to these chemicals.

Proposition 65 also prohibits California businesses from knowingly discharging significant amounts of listed chemicals into sources of drinking water.

Proposition 65 requires California to publish a list of chemicals known to cause cancer, birth defects or other reproductive harm. This list, which must be updated at least once a year, has grown to include approximately 900 chemicals since it was first published in 1987.

#### • What types of chemicals are on the Proposition 65 list?

The list contains a wide range of naturally occurring and synthetic chemicals that include additives or ingredients in pesticides, common household products, food, drugs, dyes, or solvents. Listed chemicals may also be used in manufacturing and construction, or they may be byproducts of chemical processes, such as motor vehicle

#### • What does a warning mean?

If a warning is placed on a product label or posted or distributed at a workplace, a business, or in rental housing, the business issuing the warning is aware or believes that it is exposing individuals to one or more listed chemicals.

By law, a warning must be given for listed chemicals unless the exposure is low enough to pose no significant risk of cancer or is significantly below levels observed to cause birth defects or other reproductive harm.

#### • Where can I get more information on Proposition 65?

If you have specific questions on the administration or implementation of Proposition 65, you can contact OEHHHA's Proposition 65 program at [P65.Questions@oehha.ca.gov](mailto:P65.Questions@oehha.ca.gov), or by phone at (916) 445-6900.