

# Assembly Instructions

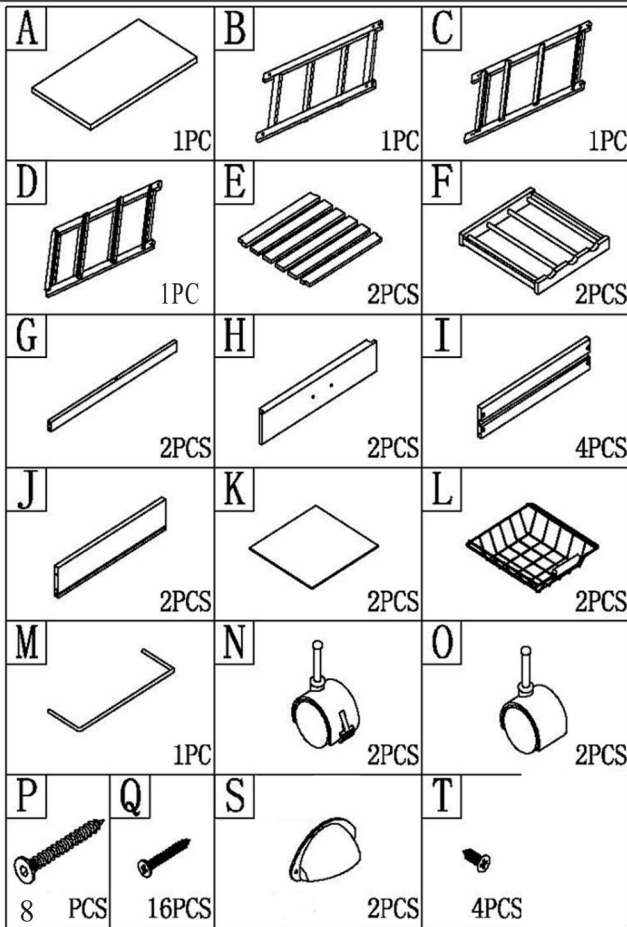

## STEP 4

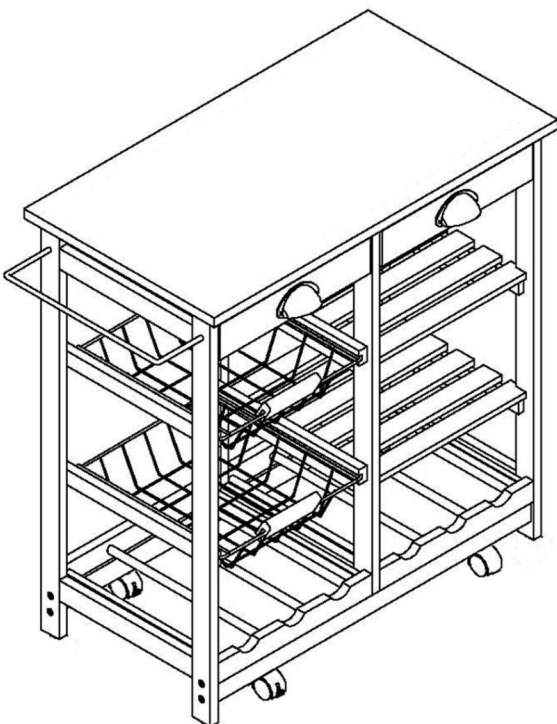

## STEP 1

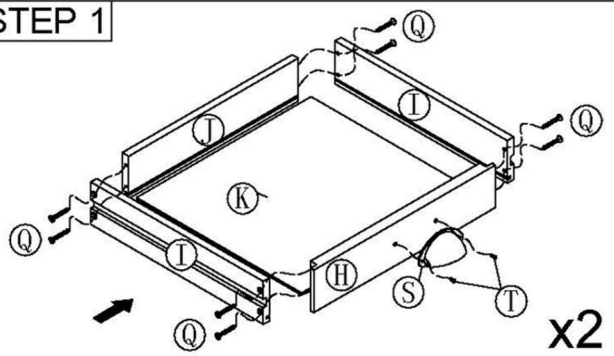

## STEP 2

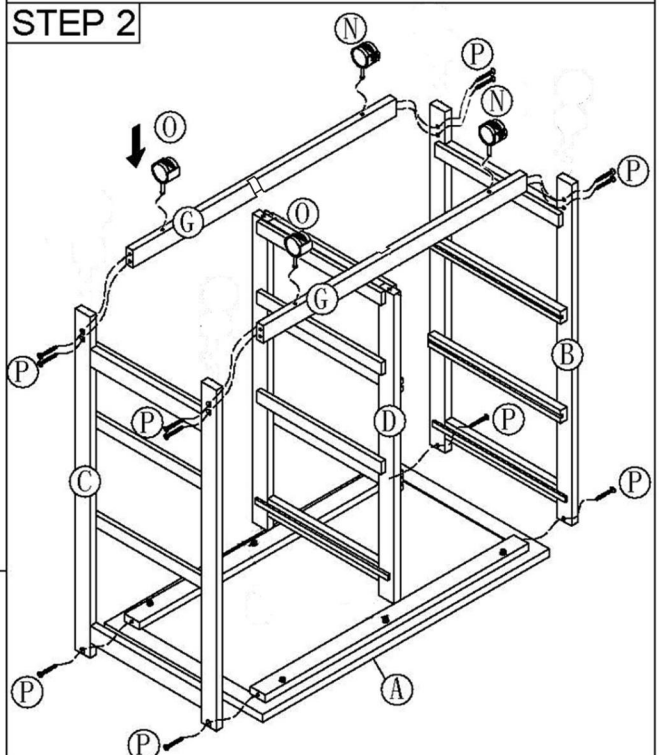

## STEP 3

