













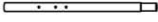







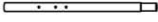



# Parts List For Bed

BED CARTON	HEADBOARD CARTON										
<p>(7) HEADBOARD PANEL                      (8) FOOTBOARD PANEL                      PART HARDWARE BAG FOR BED ATTACHMENT TO FRAME                      (1) 1/4-20 X 1 3/4" COUNTERSUNK ALLEN HEAD SCREW-4                      (2) 1/4-20 X 1" FLAT ALLEN HEAD SCREW-4                      (3) 1/4-20 HEX NUT-4                      (4) 1/4" ID X 5/8" OD FLAT WASHER-8                      (5) ALLEN WRENCH-1</p> <p>(6) LEG EXTENSION-2</p> <p>(9) PLASTIC GLIDE -4                      NOTE: GLIDES COME PRE-INSTALLED</p>	<p>(7) HEADBOARD PANEL                      PART HARDWARE BAG FOR HB ATTACHMENT TO FRAME                      (1) 1/4-20 X 1 3/4" COUNTERSUNK ALLEN HAED SCREW -4                      (3) 1/4-20 HEX NUT-4                      (4) 1/4" ID X 5/8" OD FLAT WASHER-4                      (5) ALLEN WRENCH-1</p> <p>(6) LEG EXTENSION-2</p> <p>(9) PLASTIC GLIDE -2                      NOTE: GLIDES PRE-INSTALLED</p>	<table border="1" style="width: 100%; border-collapse: collapse;"> <tr> <td style="width: 20%; text-align: center;">1 </td> <td style="width: 20%; text-align: center;">2 </td> <td style="width: 20%; text-align: center;">3 </td> <td style="width: 20%; text-align: center;">4 </td> <td style="width: 20%; text-align: center;">5 </td> </tr> <tr> <td style="width: 50%; text-align: center;">6 </td> <td style="width: 50%; text-align: center;">7 </td> </tr> <tr> <td style="width: 50%; text-align: center;">8 </td> <td style="width: 50%; text-align: center;">9 </td> </tr> </table>	1 	2 	3 	4 	5 	6 	7 	8 	9 
1 	2 	3 	4 	5 							
6 	7 										
8 	9 										

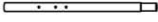
## PRODUCT FULLY ASSEMBLED

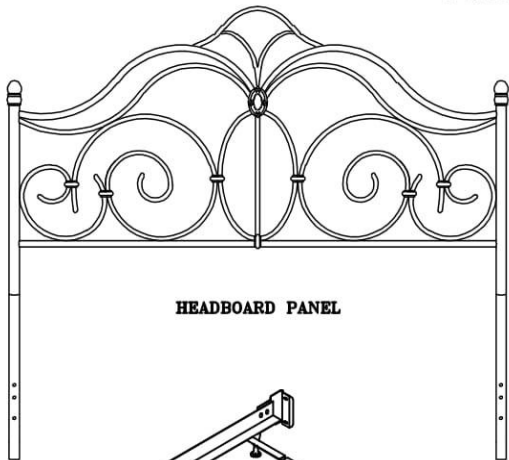

HEADBOARD PANEL

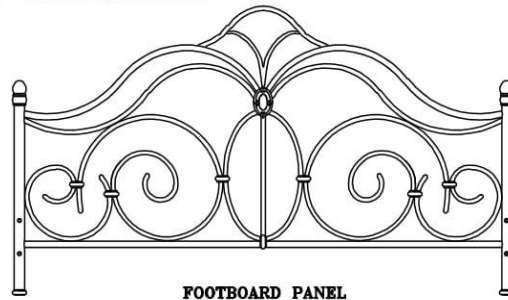

FOOTBOARD PANEL

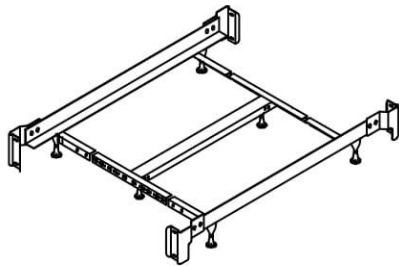

QUEEN - KING BED FRAME FULLY ASSEMBLED  
 NOTE: SEE INSTRUCTIONS INCLUDED IN FRAME CARTON FOR FRAME ASSEMBLY

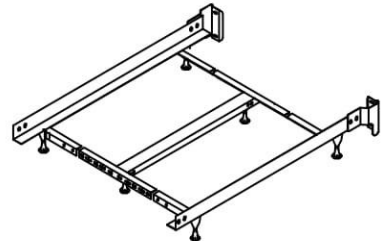

QUEEN - KING HEADBOARD ONLY FRAME FULLY ASSEMBLED  
 NOTE: SEE INSTRUCTIONS INCLUDED IN FRAME CARTON FOR FRAME ASSEMBLY

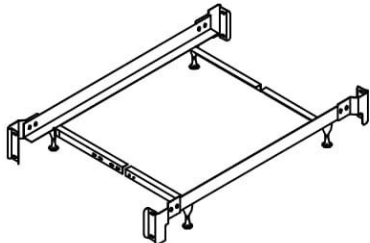

TWIN - FULL BED FRAME FULLY ASSEMBLED  
 NOTE: SEE INSTRUCTIONS INCLUDED IN FRAME CARTON FOR FRAME ASSEMBLY

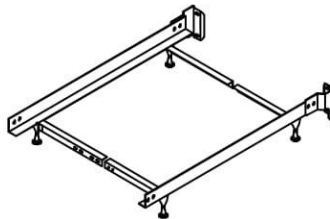

TWIN - FULL HEADBOARD ONLY FRAME FULLY ASSEMBLED  
 NOTE: SEE INSTRUCTIONS INCLUDED IN FRAME CARTON FOR FRAME ASSEMBLY

FOR ASSISTANCE IN ASSEMBLY ONLY OF THIS PRODUCT. CALL OUR HELP DESK

OUR PRODUCT IS INSPECTED TO ENSURE IT IS IN GOOD CONDITION. IF YOUR FURNITURE APPEARS TO HAVE BEEN DAMAGED IN SHIPMENT OR YOU ARE IN NEED OF REPLACEMENT PARTS PLEASE CONTACT THE DEALER FROM WHOM YOU PURCHASED THE PRODUCT.

# Instruction Sheet

SAVE ALL PACKAGING MATERIALS UNTIL PRODUCT IS FULLY ASSEMBLED. HARDWARE AND SMALL PIECES MAY NOT BE SEEN AND COULD BE ACCIDENTALLY DISCARDED WITH PACKAGING MATERIALS.

FIGURE 1

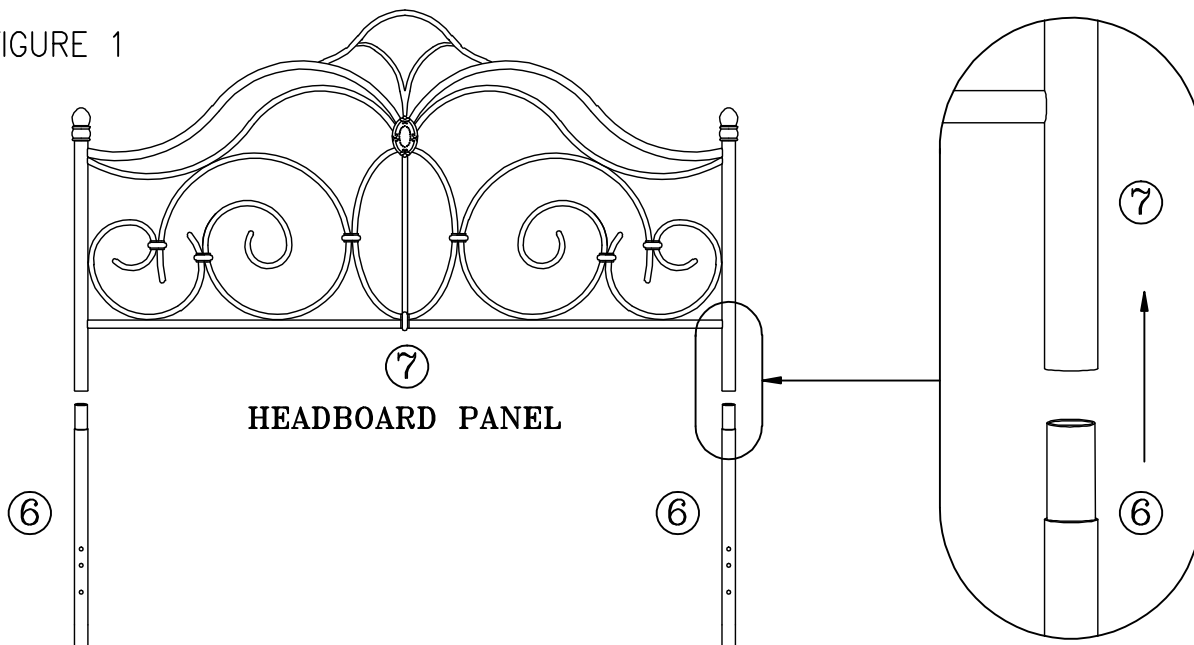
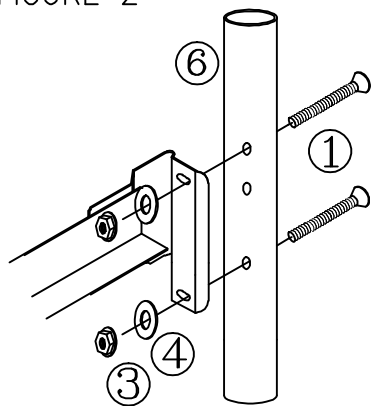

FIGURE 2



### Step 1

- Align top reduction of extension legs (6) with bottom of headboard posts. (See Figure 1) Make sure the 3 holes on extension legs are perpendicular to headboard panel.
- Now carefully insert extension legs (6) into bottom of headboard (7) posts. (See Figure 1)

### Step 2

- Place headboard and frame in desired location in room.
- Place 2 screws (1) through holes located in leg extension(6). (See Figure 2)
- Align bed frame bracket over screws.
- Place a flat washer (4) over screws first and then a nut (3) on each screw. Hand-tighten, DO NOT TIGHTEN screws all the way.
- Repeat on other side of headboard.
- Tighten all screws securely using the Allen wrench (5).

FIGURE 3

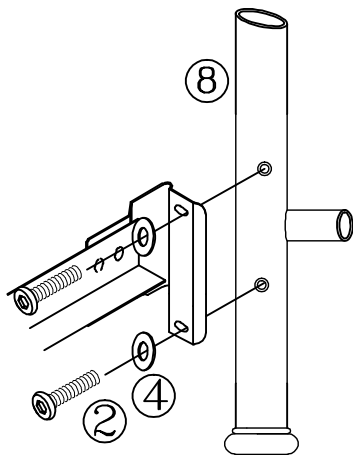

### Step 3

- Position footboard panel (8) and align holes in the post with holes in the frame bracket. (See figure 3)
- Place flat washer (4) on each screw (2). Insert through bracket and into footboard post Hand-tighten, DO NOT TIGHTEN screws all the way.
- Repeat on other side of footboard panel.
- Tighten all screws securely using the Allen wrench (5).