

WARNING

- * Switch off the main electrical supply from the main fuse box / circuit breaker before installation.
- * Inspect item carefully before attempting to install.
- * If there is any damages or obvious defects, do not install.
- * Item may not be returned once it has been installed.

CARE AND MAINTENANCE











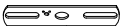

- * To clean the outside of the fixture, use a dry or slightly dampened clean cloth (use clean water, never a solvent) to wipe the surface of the fixture.
- * To clean the inside of the fixture, first disconnect power to the fixture by turning off the circuit breaker or by removing the fuse at the fuse box. Next, use a dry or slightly dampened clean cloth (use clean water, never a solvent) to wipe the interior surface of the fixture.
- * Do not use any cleaners with chemical, solvents or harsh abrasives. Use only a dry soft cloth to dust or wipe carefully.

NOTICE& IMPORTANT SAFETY INSTRUCTIONS

** WE RECOMMEND INSTALLATION OF THIS LIGHTING FIXTURE BE DONE BY A LICENSED ELECTRICIAN **

- * Please make sure that you have all parts indicated before you begin assembly of this item
- * This item should be assembled on a soft surface to prevent scratching the finish during assembly
- * To reduce the risk of fire, electrical shock or injury to persons or property, please follow the guideline below for safe use and installation
- *The external flexible cable or cord of this lamp cannot be replaced
If the cord is damaged, the lamp shall be destroyed



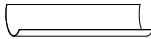



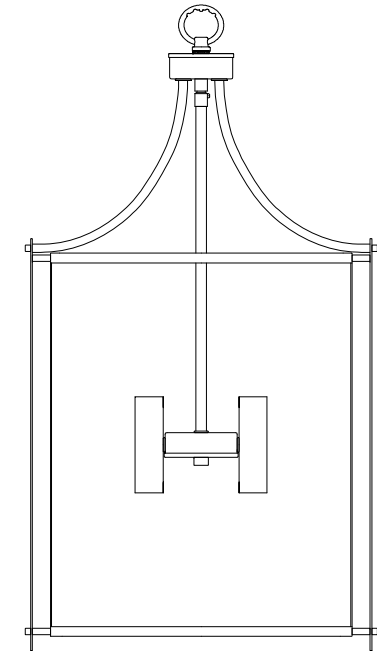

Part List and Hardware List

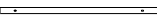
PIECE	DESCRIPTION	PICTURE	QUANTITY	PIECE	DESCRIPTION	PICTURE	QUANTITY
A	Wire		3X	M	Fixture Body		1X
B	Mounting Bar		1X	N	Loop		1X
C	Mounting Screws		2X	O	Rod		1X
D	Ground Screw		1X	P	Frame		1X
E	Nex Nut		1X	Q	Finial		3X
F	Nipple		1X	R	Bulb		6X
G	Knurled Nut		1X	S	Clear Glass		3X

1/4

Product Dimensions: 15"L X 15"W X 35.5-107.5"H



PIECE	DESCRIPTION	PICTURE	QUANTITY	PIECE	DESCRIPTION	PICTURE	QUANTITY
H	Canopy		1X	T	Metal Board		3X
I	Collar loop		1X	U	Screws		6X
J	Quick link		2X	V	Phillips Screwdriver		1X
K	Chain		1X	W	Wire Housing		1X
L	Collar loop ring		1X				

PREPARATION

- * Before beginning assembly of product, make sure all parts are present. Compare parts with package contents list and hardware contents list.
- * If any part is missing or damaged, do not attempt to assemble the product.
- * Estimated Assembly Time: 30 minutes.
- * Tools Required for Assembly (not included): Screwdriver, Junction box
- * If you are having difficulty, our friendly Customer Care team is always here to help.

NOTE: PLEASE USE TYPE"A" BULB MAX 60-WATT OR LED BULB MAX 9-WATT, THERE IS LED 4-WATT BULB IN THE BOX

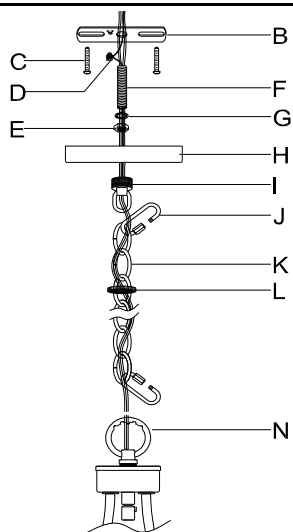

Step 1: Unpack all parts from cartons carefully.

Place the Canopy (H) onto the Collar loop (I), Screw the Nipple (F) into the threaded portion of the Collar loop (I) and fix it by turning the Nipple (F) clockwise till tight. Attach the Quick link (J) onto the Collar loop (N)

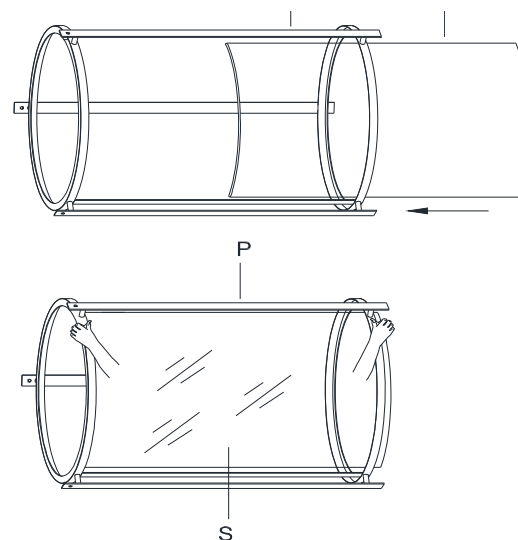

Step 2: Slowly lay the Frame flat and insert the clear glass(S) into the groove in the Frame(P).

PREPARATION

- * Before beginning assembly of product, make sure all parts are present. Compare parts with package contents list and hardware contents list.
- * If any part is missing or damaged, do not attempt to assemble the product.
- * Estimated Assembly Time: 20 minutes.
- * Tools Required for Assembly (not included): Screwdriver, Junction box
- * If you are having difficulty, our friendly Customer Care team is always here to help.

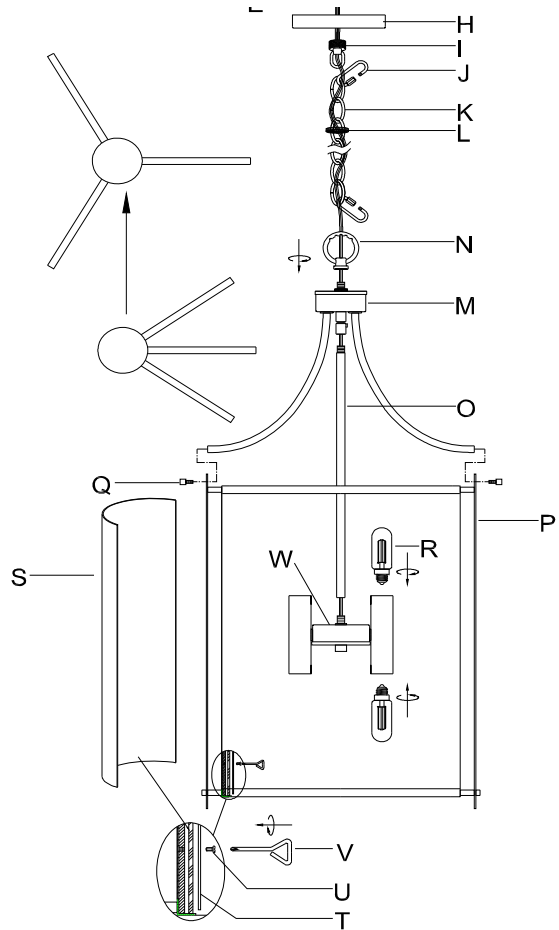

Step 3: Secure with a Metal Board(T). Tighten the Screws(U) with a Phillips Screwdriver(V) .
Thread the Fixture Body (M) to top of Loop (N). Attach the Quick link (J) onto the Fixture Body (N).
The Frame(P) is aligned with the Fixture Body(M) and is fixed with the Finial(Q).

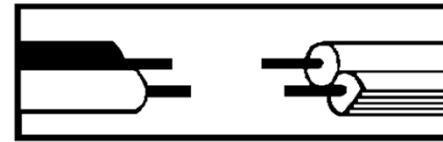

Step 4: Wire connection

Connect fixture neutral wire (ribbed) to the outlet box neutral wire (usually white) using a wire connector (D).

Connect fixture hot wire (smooth with markings) to the outlet box hot wire (usually black) using a wire connector (D).

CAUTION: Do not reverse the hot and neutral connections

Grounding Instructions:

Wrap ground wire from outlet box around green ground screw(C) on mounting bracket, no less than 2" from wire end. Tighten ground screw. If fixture is supplied with a ground wire, connect to outlet ground wire with a wire connector (D).

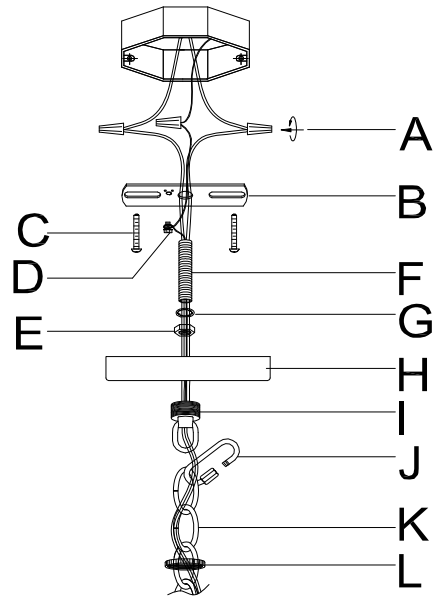

Step 5: Separate the Mounting Bar (B) from the Canopy (H) by unscrewing the Collar loop ring (L).
 Install the Mounting Bar (B) to the junction box with Mounting Screws (C).
 Attach the Canopy (H) to the junction box and fix it by turning the Collar loop ring (L) clockwise.

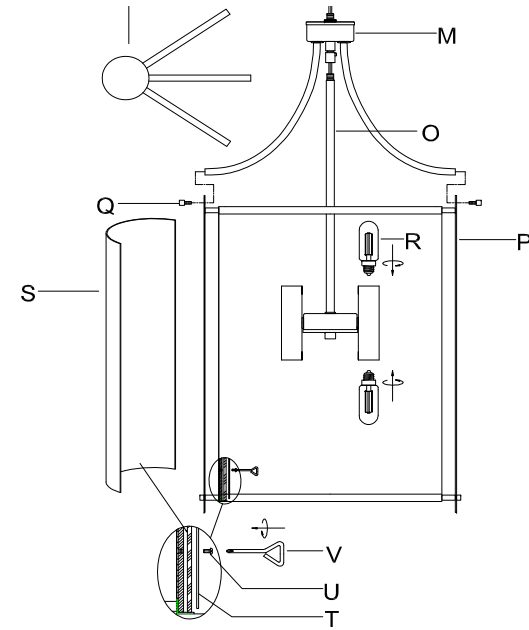

Step 6: Lock the Bulb(R) into the lamp base.