

INSTRUCTION

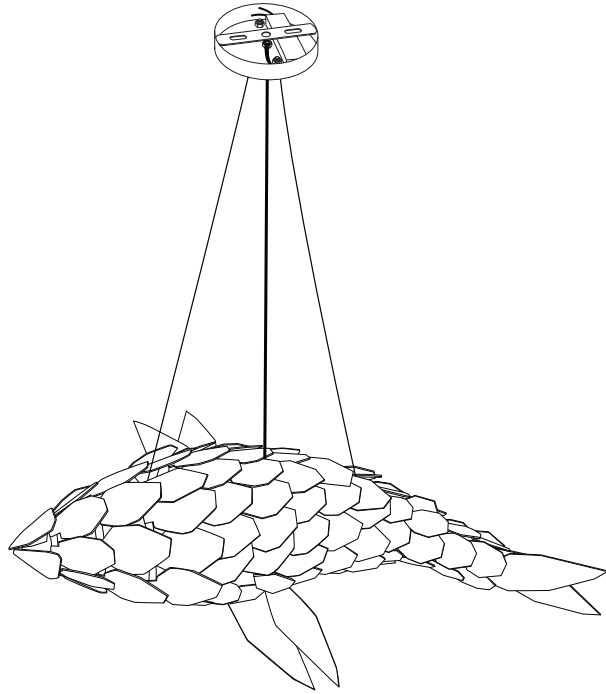

A *1

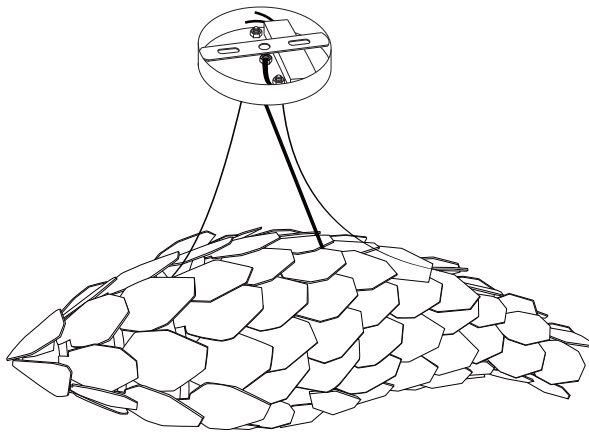

B *6



C *6



D *10



E *2

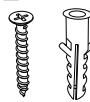

F *2



G *2



1

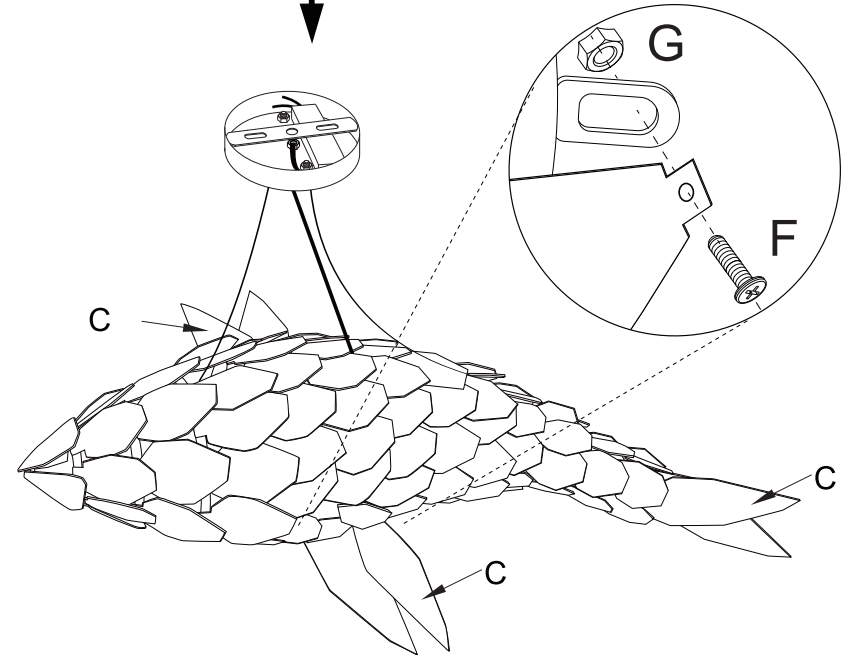
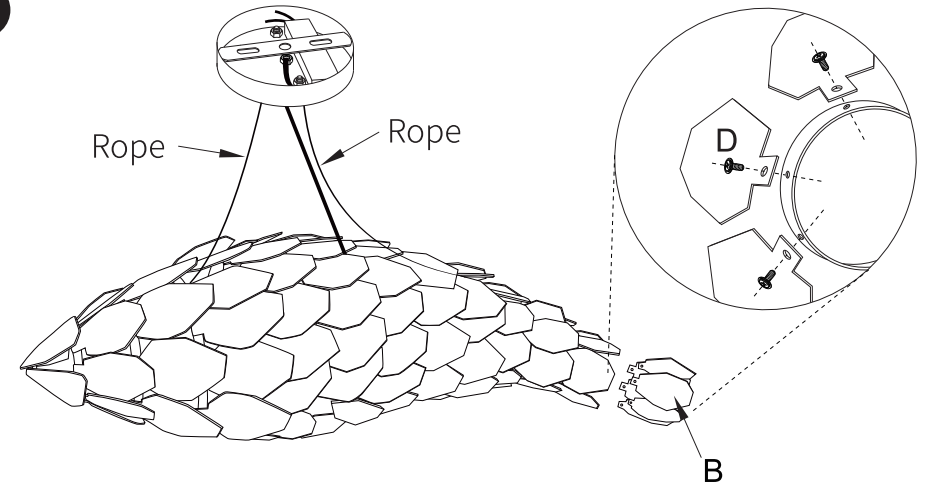

Use screws D to fix B and C.

2

Unscrew the side screws to remove the ceiling plate bracket then fix it to ceiling.

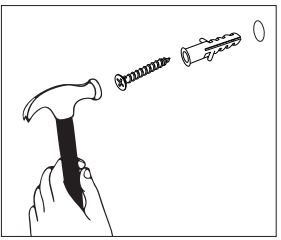
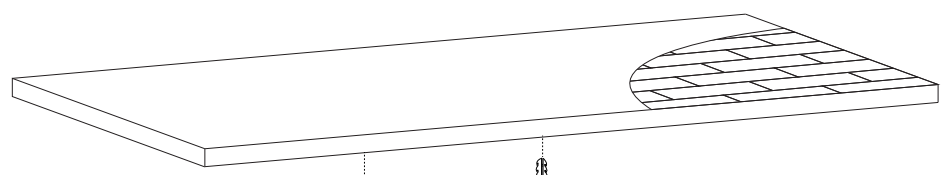
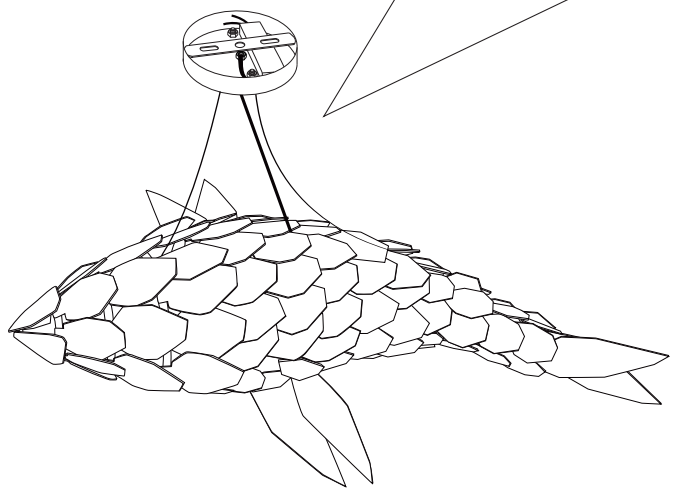
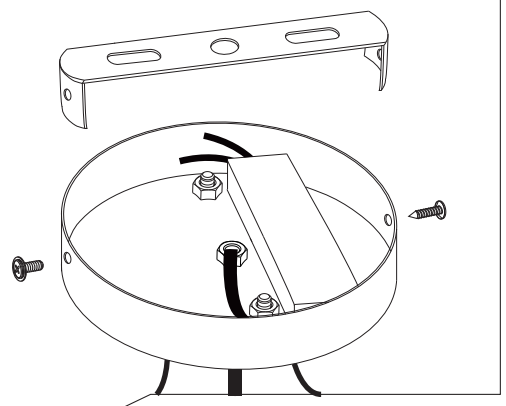

3

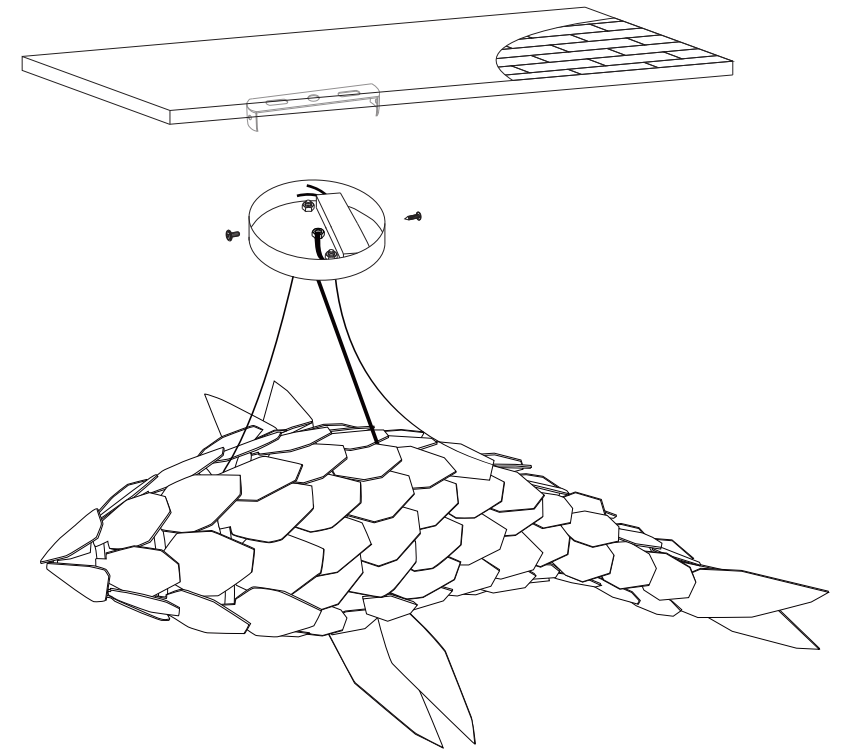

Fix the side to the ceiling plate and connect the wires to home wires.

