

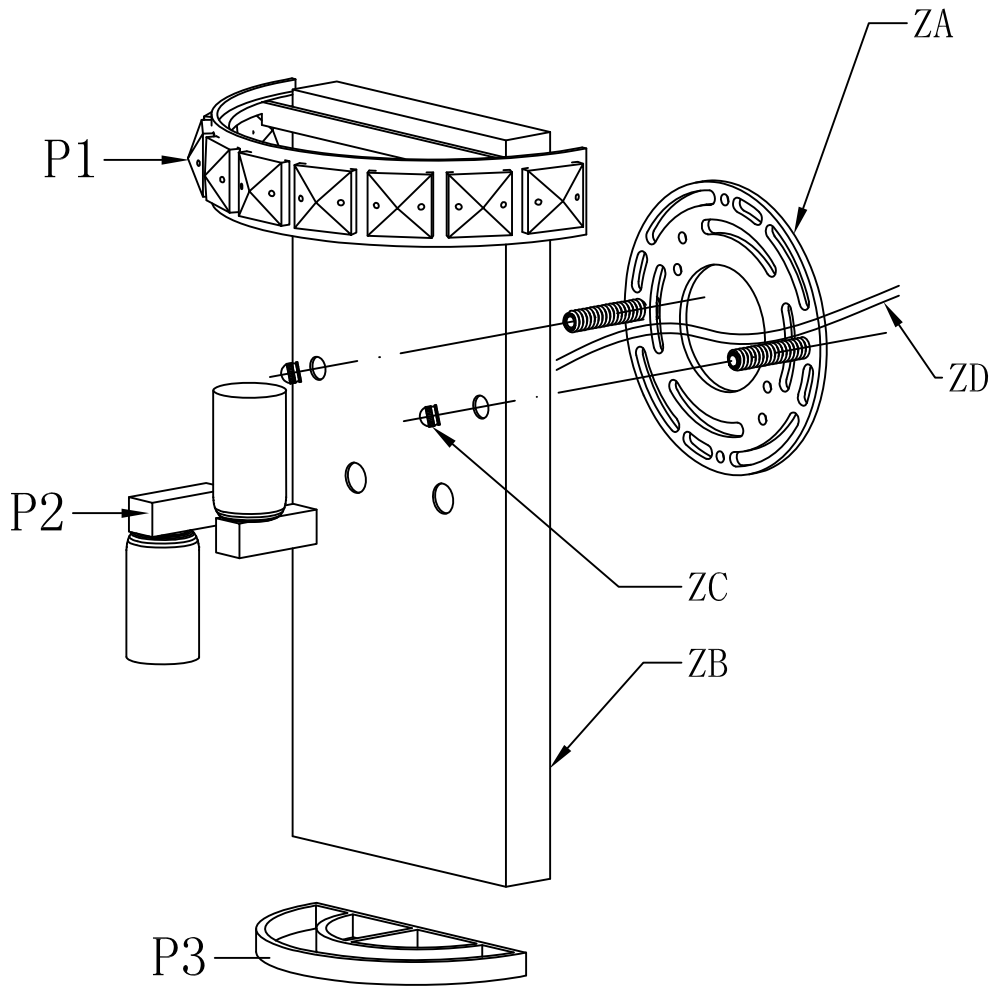

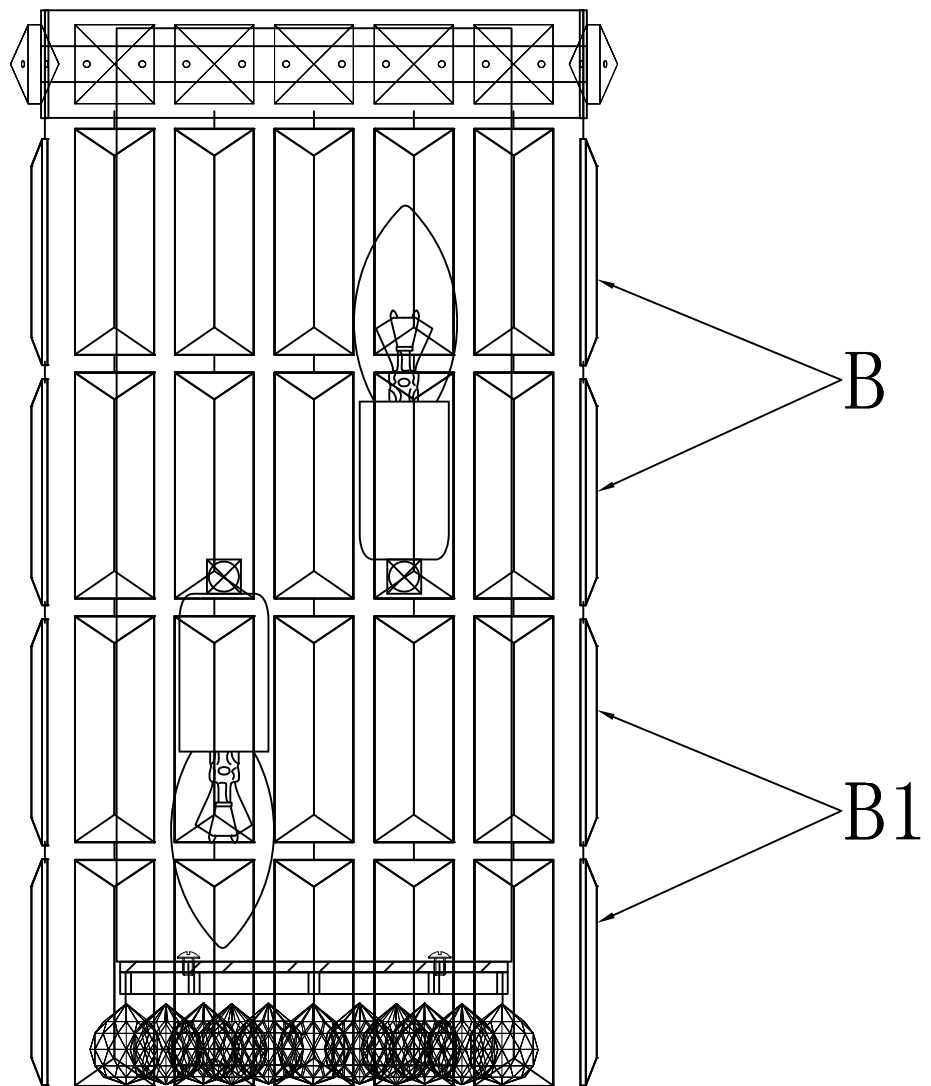





Frame Parts List

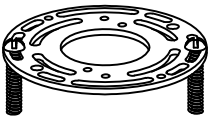
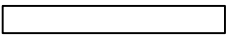

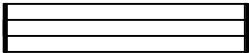
Crystal Parts List

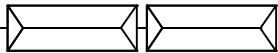

C

	Picture	Description	Qty	Diagram Number
		crossbar	1	ZA
		Back plate 10.2"	1	ZB
		Knurled nut	2	ZC
		Power Cord 12" SPT-1-18#	1	ZD
		Lamp body (2)	1	P1
		Socket	2	P2
		Lamp body (1)	1	P3
		610-2.5"*2	9	B
		610-2.5"*1+ 611-2.5"*1	9	B1
		701-20#	12	C