

ASSEMBLY INSTRUCTIONS INSTRUCTIONS DE MONTAGE INSTRUCCIONES DE MONTAJE

DRAWER NIGHTSTAND

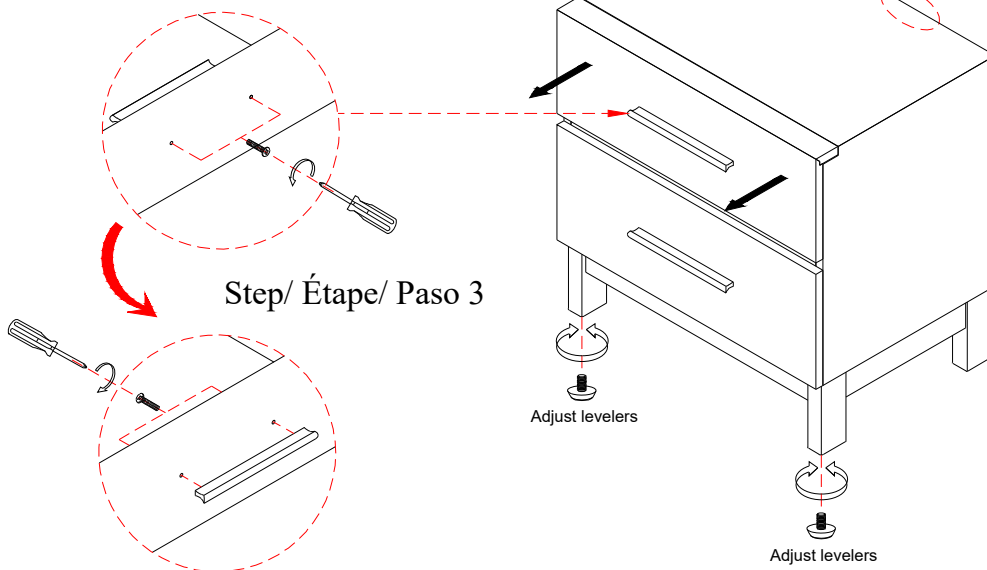

NOTE:
 Spirit level not included but necessary to level product on floor.
 Niveau à bulle non inclus mais nécessaire pour niveler le produit au sol.
 Nivel de burbuja no incluido pero necesario para nivelar el producto en el piso.

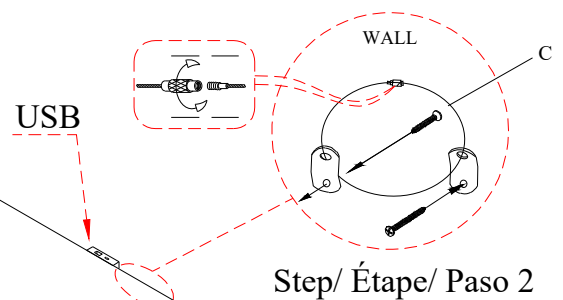
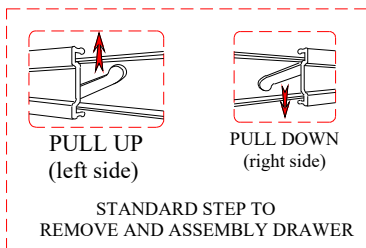
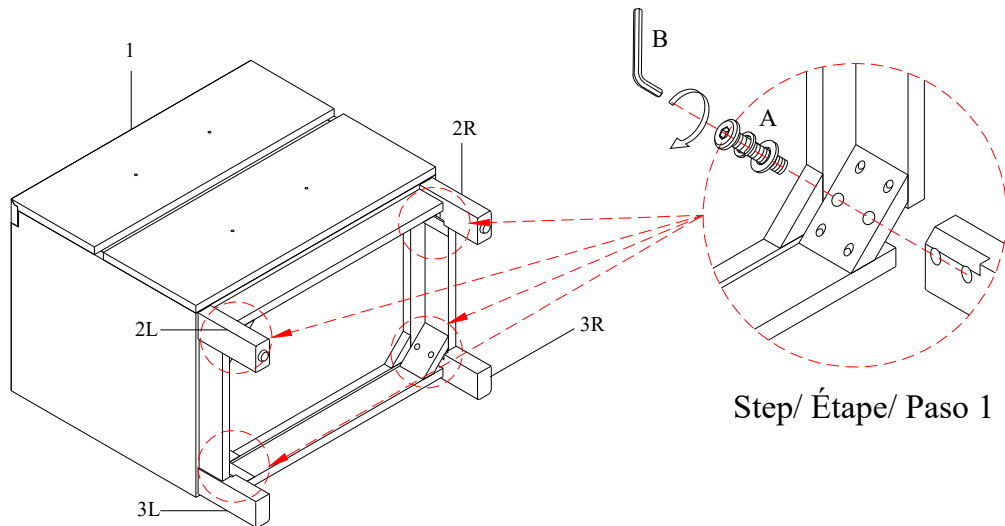

WARNING:
 ONLY USE THE HAND
 TOOLS PROVIDED

ASSEMBLY INSTRUCTIONS INSTRUCTIONS DE MONTAGE INSTRUCCIONES DE MONTAJE

DRAWER CHEST



CAUTION: PLEASE READ ALL INSTRUCTIONS BEFORE STARTING THE ASSEMBLY OF THIS PRODUCT. THESE PIECES ARE HEAVY. IN ORDER TO PREVENT PERSONAL INJURY AND ENSURE THAT THIS PRODUCT IS NOT DAMAGED DURING THE ASSEMBLY PROCESS, IT IS STRONGLY RECOMMENDED TO ENLIST THE ASSISTANCE OF ONE OR MORE PERSONS. IN CASE OF EXCESS STAIN, WIPE THE BOTTOM OF THE UNIT BEFORE PLACING ON ANY SURFACE.

ATTENTION: VEUILLEZ LIRE TOUTES LES INSTRUCTIONS AVANT DE COMMENCER L'ASSEMBLAGE DE CE PRODUIT. LES PIÉCES SONT LOURDES. POUR ÉVITER TOUTE BLESSURE ET POUR VOUS ASSURER QUE LE PRODUIT N'EST PAS ENDOMMAGÉ PENDANT L'ASSEMBLAGE, NOUS VOUS RECOMMANDONS DE FAIRE APPEL À UNE OU PLUSIEURS AUTRES PERSONNES. EN CAS DE TACHE EXCESSIVE, ESSUYEZ LE FOND DE L'UNITÉ AVANT LE PLACEMENT SUR N'IMPORTE QUELLE SURFACE.



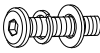

CUIDADO: FAVOR DE LEER TODAS LAS INSTRUCCIONES ANTES DE ENSAMBLAR SU PRODUCTO, ESTAS PIEZAS SON PESADAS. PARA PREVENIR HERIDAS PERSONALES Y ASEGURAR QUE SU PRODUCTO NO SEA DAÑADO MIENTRAS ES ENSAMBLADO. SE RECOMIENDA LA ASISTENCIA DE UNA O MÁS PERSONAS.

WARNING: PROTECTIVE GLIDE IS PLACED UNDER EACH LEG OF THE FURNITURE TO RESIST SCRATCHES ON FLOOR SURFACE. SOME FLOOR SURFACES CAN BE EXTRA SENSITIVE TO SCRATCHES AND MARKINGS, IF YOU ARE NOT SURE CONSULT WITH YOUR DEALER. AVERTISSEMENT. LES PIEDS DES MEUBLES SONT MUNIS DE PATINS DESTINÉS À PROTÉGER LE PLANCHER. CERTAINS REVÊTEMENTS DE SOL PEUVENT ÊTRE TRÈS FRAGILES. EN CAS DE DOUTE. CONSULTER LE MARCHAND.

LIST OF PARTS AND HARDWARE/ LISTE DES PIÈCES ET DU MATÉRIEL/ LISTA DE PIEZAS Y HARDWARE

NO#/ NOMBRE/ NÚMERO	DESCRIPTION/ DESCRIPTION/ DESCRIPCIÓN	QUANTITY/ QUANTITÉ/ CANTIDAD
A	FLAT WASHER/ RONDELLE PLATE/ ARANDELA PLANA Ø5/16"x19x2mm	
	LOCK WASHER/ RONDELLE DE BLOQUEAGE/ARANDELA DE BLOQUEO Ø5/16"x12x2mm	
	BOLT/ BOULON/ TORNILLO Ø5/16" x 2-1/2"L	
B	ALLEN KEY/ CLÉ ALLEN/ LLAVE INGLESA ALLEN M4	 1 PC
C	TILT KIT BRACKET/SUPPORT KIT D'INCLINAISON/ SOPORTE DEL KIT INCLINACIÓN	 1 SET

LIST OF PARTS AND HARDWARE/ LISTE DES PIÈCES ET DU MATÉRIEL/ LISTA DE PIEZAS Y HARDWARE

NO#/ NOMBRE/ NÚMERO	DESCRIPTION/ DESCRIPTION/ DESCRIPCIÓN	QUANTITY/ QUANTITÉ/ CANTIDAD
1	DRAWER CHEST	 1 PC
2L	FRONT LEFT LEG / JAMBE AVANT GAUCHE / PIERNA DELANTERA IZQUIERDA	 1 PC
2R	FRONT RIGHT LEG / JAMBE AVANT DROITE / PIERNA DELANTERA DERECHA	 1 PC
3L	BACK LEFT LEG / JAMBE ARRIÈRE GAUCHE / PIERNA TRASERA IZQUIERDA	 1 PC
3R	BACK RIGHT LEG / JAMBE ARRIÈRE DROITE / PIERNA TRASERA DERECHA	 1 PC

NOTE:
ASSEMBLE UNIT ON A SOFT SURFACE.
ASSEMBLEZ L'UNITÉ SUR UNE SURFACE MOLLE.
ENSAMBLE LA UNIDAD EN UNA SUPERFICIE PLANA Y SUAVE.

DO NOT TIGHTEN BOLTS UNTIL **ALL PARTS AND HARDWARE** OF THE UNIT ARE ASSEMBLED.
NE SERREZ PAS LES BOULONS JUSQU'À CE QUE L'UNITÉ SOIT COMPLÈTEMENT ASSEMBLÉE.
NO APRIETE LOS TORNILLOS HASTA QUE LA UNIDAD ESTE COMPLETAMENTE ENSAMBLADA.



WARNING:
ONLY USE THE HAND
TOOLS PROVIDED

ASSEMBLY INSTRUCTIONS INSTRUCTIONS DE MONTAGE INSTRUCCIONES DE MONTAJE DRAWER CHEST

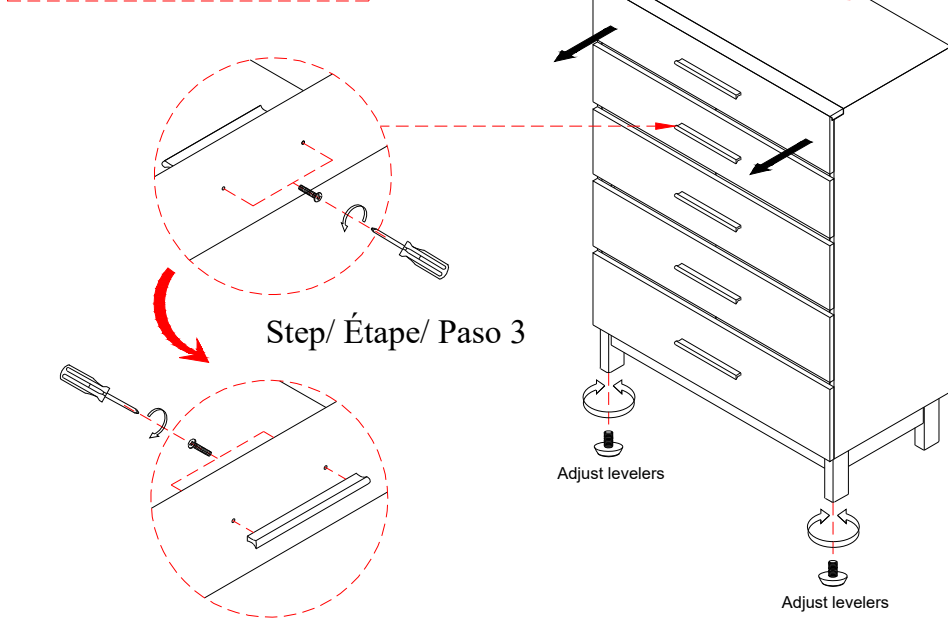
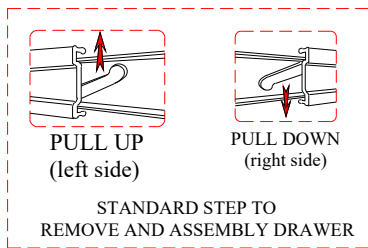
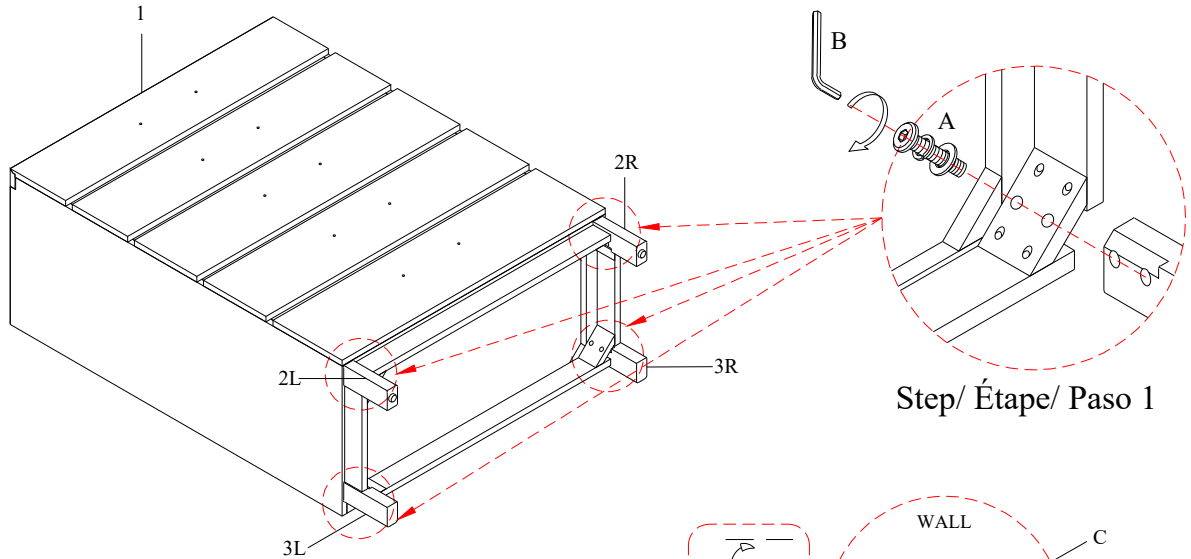

NOTE:
 Spirit level not included but necessary to level product on floor.
 Niveau à bulle non inclus mais nécessaire pour niveler le produit au sol.
 Nivel de burbuja no incluido pero necesario para nivelar el producto en el piso.



WARNING:
 ONLY USE THE HAND
 TOOLS PROVIDED

ASSEMBLY INSTRUCTIONS

INSTRUCTIONS DE MONTAGE

INSTRUCCIONES DE MONTAJE

DRAWER DRESSER



CAUTION: PLEASE READ ALL INSTRUCTIONS BEFORE STARTING THE ASSEMBLY OF THIS PRODUCT. THESE PIECES ARE HEAVY. IN ORDER TO PREVENT PERSONAL INJURY AND ENSURE THAT THIS PRODUCT IS NOT DAMAGED DURING THE ASSEMBLY PROCESS, IT IS STRONGLY RECOMMENDED TO ENLIST THE ASSISTANCE OF ONE OR MORE PERSONS. IN CASE OF EXCESS STAIN, WIPE THE BOTTOM OF THE UNIT BEFORE PLACING ON ANY SURFACE.

ATTENTION: VEUILLEZ LIRE TOUTES LES INSTRUCTIONS AVANT DE COMMENCER L'ASSEMBLAGE DE CE PRODUIT. LES PIÉCES SONT LOURDES. POUR ÉVITER TOUTE BLESSURE ET POUR VOUS ASSURER QUE LE PRODUIT N'EST PAS ENDOMMAGÉ PENDANT L'ASSEMBLAGE, NOUS VOUS RECOMMANDONS DE FAIRE APPEL À UNE OU PLUSIEURS AUTRES PERSONNES. EN CAS DE TACHE EXCESSIVE, ESSUYEZ LE FOND DE L'UNITÉ AVANT LE PLACEMENT SUR N'IMPORTE QUELLE SURFACE.





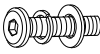

CUIDADO: FAVOR DE LEER TODAS LAS INSTRUCCIONES ANTES DE ENSAMBLAR SU PRODUCTO, ESTAS PIEZAS SON PESADAS. PARA PREVENIR HERIDAS PERSONALES Y ASEGURAR QUE SU PRODUCTO NO SEA DAÑADO MIENTRAS ES ENSAMBLADO. SE RECOMIENDA LA ASISTENCIA DE UNA O MÁS PERSONAS.

WARNING: PROTECTIVE GLIDE IS PLACED UNDER EACH LEG OF THE FURNITURE TO RESIST SCRATCHES ON FLOOR SURFACE. SOME FLOOR SURFACES CAN BE EXTRA SENSITIVE TO SCRATCHES AND MARKINGS, IF YOU ARE NOT SURE CONSULT WITH YOUR DEALER. AVERTISSEMENT. LES PIEDS DES MEUBLES SONT MUNIS DE PATINS DESTINÉS À PROTÉGER LE PLANCHER. CERTAINS REVÊTEMENTS DE SOL PEUVENT ÊTRE TRÈS FRAGILES. EN CAS DE DOUTE. CONSULTER LE MARCHAND.

LIST OF PARTS AND HARDWARE/ LISTE DES PIÈCES ET DU MATÉRIEL/ LISTA DE PIEZAS Y HARDWARE

NO#/ NOMBRE/ NÚMERO	DESCRIPTION/ DESCRIPTION/ DESCRIPCIÓN	QUANTITY/ QUANTITÉ/ CANTIDAD
A	FLAT WASHER/ RONDELLE PLATE/ ARANDELA PLANA Ø5/16"x19x2mm	
	LOCK WASHER/ RONDELLE DE BLOCAGE/ARANDELA DE BLOQUEO Ø5/16"x12x2mm	
	BOLT/ BOULON/ TORNILLO Ø5/16" x 2-1/2"L	
B	ALLEN KEY/ CLÉ ALLEN/ LLAVE INGLESA ALLEN M4	 1 PC
C	TILT KIT BRACKET/SUPPORT KIT D'INCLINAISON/ SOPORTE DEL KIT INCLINACIÓN	 1 SET

LIST OF PARTS AND HARDWARE/ LISTE DES PIÈCES ET DU MATÉRIEL/ LISTA DE PIEZAS Y HARDWARE

NO#/ NOMBRE/ NÚMERO	DESCRIPTION/ DESCRIPTION/ DESCRIPCIÓN	QUANTITY/ QUANTITÉ/ CANTIDAD
1	DRAWER DRESSER	 1 PC
2L	FRONT LEFT LEG / JAMBE AVANT GAUCHE / PIERNA DELANTERA IZQUIERDA	 1 PC
2R	FRONT RIGHT LEG / JAMBE AVANT DROITE / PIERNA DELANTERA DERECHA	 1 PC
3L	BACK LEFT LEG / JAMBE ARRIÈRE GAUCHE / PIERNA TRASERA IZQUIERDA	 1 PC
3R	BACK RIGHT LEG / JAMBE ARRIÈRE DROITE / PIERNA TRASERA DERECHA	 1 PC
4	SUPPORT LEG/ JAMBE DE SOUTIEN/ PIERNA DE APOYO 127x34x34mm	 1 PC

NOTE:
ASSEMBLE UNIT ON A SOFT SURFACE.
ASSEMBLEZ L'UNITÉ SUR UNE SURFACE MOLLE.
ENSAMBLE LA UNIDAD EN UNA SUPERFICIE PLANA Y SUAVE.

DO NOT TIGHTEN BOLTS UNTIL ALL PARTS AND HARDWARE OF THE UNIT ARE ASSEMBLED.
NE SÉRREZ PAS LES BOULONS JUSQU'À CE QUE L'UNITÉ SOIT COMPLÈTEMENT ASSEMBLÉE.
NO APRIETE LOS TORNILLOS HASTA QUE LA UNIDAD ESTE COMPLETAMENTE ENSAMBLADA.



WARNING:
ONLY USE THE HAND
TOOLS PROVIDED

ASSEMBLY INSTRUCTIONS INSTRUCTIONS DE MONTAGE INSTRUCCIONES DE MONTAJE

DRAWER DRESSER

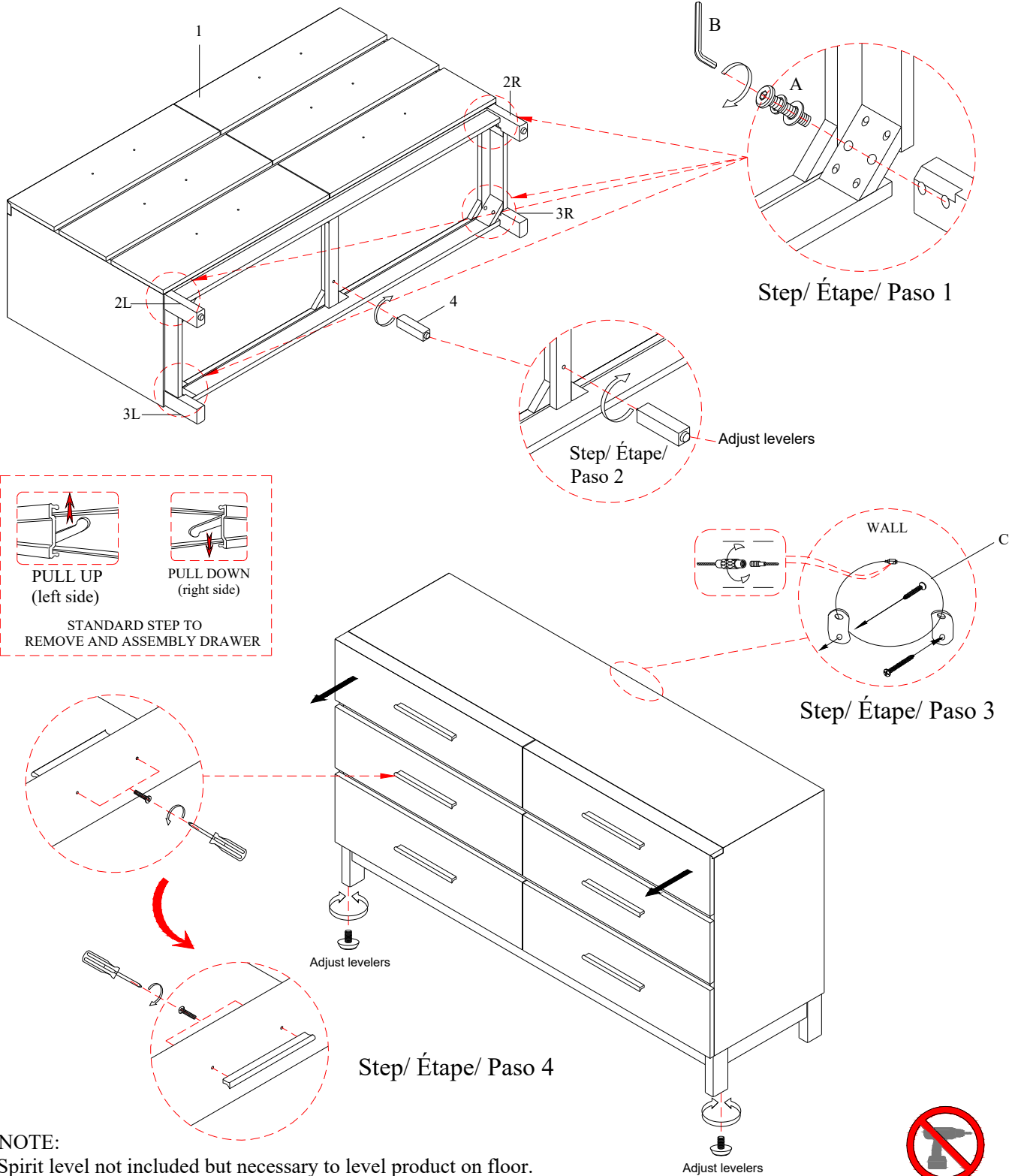

NOTE:

Spirit level not included but necessary to level product on floor.
 Niveau à bulle non inclus mais nécessaire pour niveler le produit au sol.
 Nivel de burbuja no incluido pero necesario para nivelar el producto en el piso.



WARNING:
 ONLY USE THE HAND
 TOOLS PROVIDED

ASSEMBLY INSTRUCTIONS
INSTRUCTIONS DE MONTAGE
INSTRUCCIONES DE MONTAJE
MIRROR

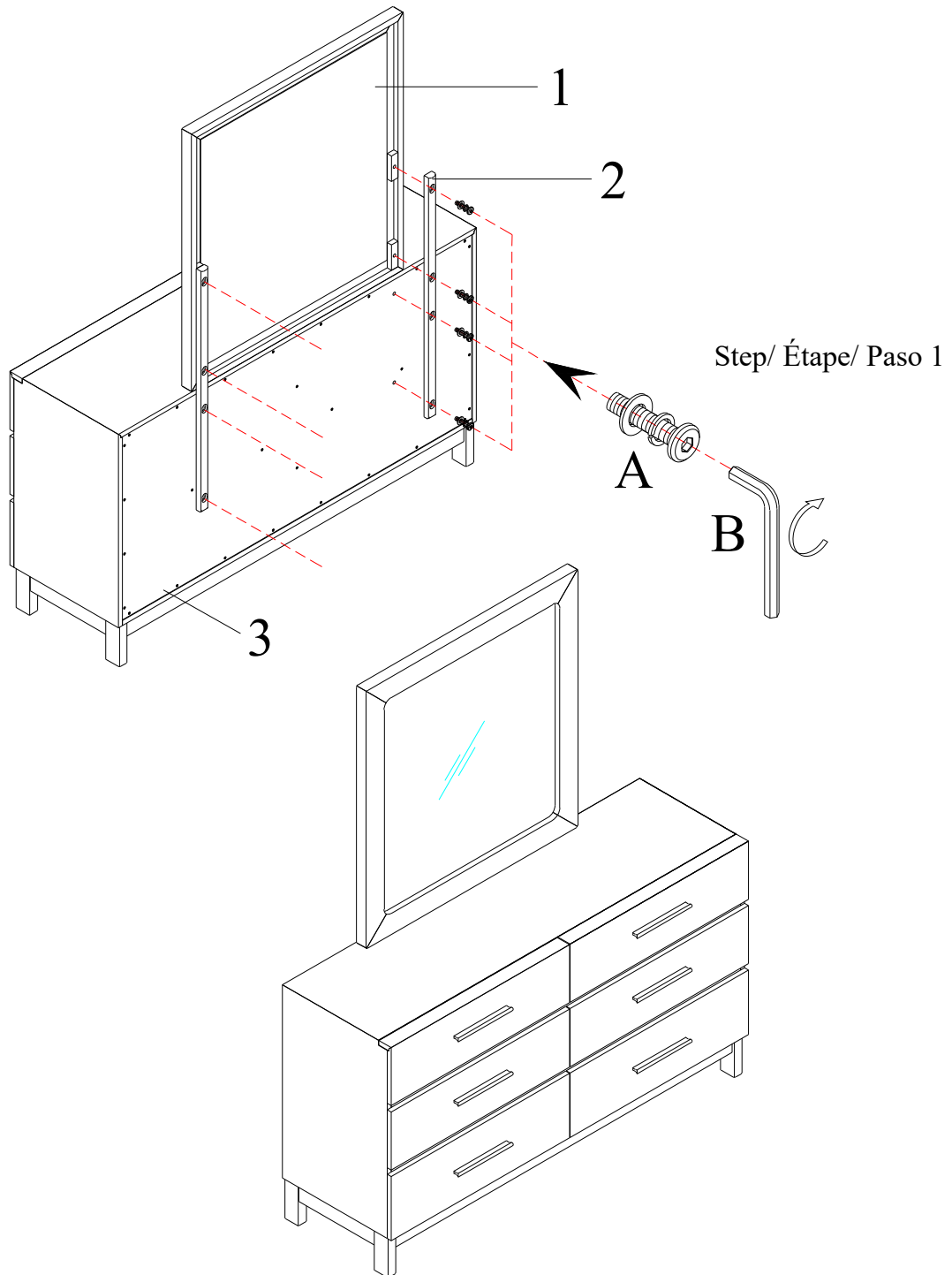

NOTE:

Spirit level not included but necessary to level product on floor.

Niveau à bulle non inclus mais nécessaire pour niveler le produit au sol.

Nivel de burbuja no incluido pero necesario para nivelar el producto en el piso.



WARNING:
ONLY USE THE HAND
TOOLS PROVIDED

ASSEMBLY INSTRUCTIONS INSTRUCTIONS DE MONTAGE INSTRUCCIONES DE MONTAJE

QUEEN PANEL BED HEADBOARD
QUEEN PANEL BED FOOTBOARD
QUEEN/KING PANEL BED RAILS









CAUTION: PLEASE READ ALL INSTRUCTIONS BEFORE STARTING THE ASSEMBLY OF THIS PRODUCT. THESE PIECES ARE HEAVY. IN ORDER TO PREVENT PERSONAL INJURY AND ENSURE THAT THIS PRODUCT IS NOT DAMAGED DURING THE ASSEMBLY PROCESS, IT IS STRONGLY RECOMMENDED TO ENLIST THE ASSISTANCE OF ONE OR MORE PERSONS. IN CASE OF EXCESS STAIN, WIPE THE BOTTOM OF THE UNIT BEFORE PLACING ON ANY SURFACE.

ATTENTION: VEUILLEZ LIRE TOUTES LES INSTRUCTIONS AVANT DE COMMENCER L'ASSEMBLAGE DE CE PRODUIT. LES PIÈCES SONT LOURDES. POUR ÉVITER TOUTE BLESSURE ET POUR VOUS ASSURER QUE LE PRODUIT N'EST PAS ENDOMMAGÉ PENDANT L'ASSEMBLAGE, NOUS VOUS RECOMMANDONS DE FAIRE APPEL À UNE OU PLUSIEURS AUTRES PERSONNES. EN CAS DE TACHE EXCESSIVE, ESSUYEZ LE FOND DE L'UNITÉ AVANT LE PLACEMENT SUR N'IMPORTE QUELLE SURFACE.









CUIDADO: FAVOR DE LEER TODAS LAS INSTRUCCIONES ANTES DE ENSAMBLAR SU PRODUCTO, ESTAS PIEZAS SON PESADAS. PARA PREVENIR HERIDAS PERSONALES Y ASEGURAR QUE SU PRODUCTO NO SEA DAÑADO MIENTRAS ES ENSAMBLADO. SE RECOMIENDA LA ASISTENCIA DE UNA O MÁS PERSONAS.

WARNING: PROTECTIVE GLIDE IS PLACED UNDER EACH LEG OF THE FURNITURE TO RESIST SCRATCHES ON FLOOR SURFACE. SOME FLOOR SURFACES CAN BE EXTRA SENSITIVE TO SCRATCHES AND MARKINGS, IF YOU ARE NOT SURE CONSULT WITH YOUR DEALER. AVERTISSEMENT. LES PIEDS DES MEUBLES SONT MUNIS DE PATINS DESTINÉS À PROTÉGER LE PLANCHER. CERTAINS REVÊTEMENTS DE SOL PEUVENT ÊTRE TRÈS FRAGILES. EN CAS DE DOUTE. CONSULTER LE MARCHAND.

LIST OF PARTS AND HARDWARE/ LISTE DES PIÈCES ET DU MATÉRIEL/ LISTA DE PIEZAS Y HARDWARE

NO#/ NOMBRE/ NÚMERO	DESCRIPTION/ DESCRIPTION/ DESCRIPCIÓN	QUANTITY/ QUANTITÉ/ CANTIDAD
A	BOLT/ BOULON/ TORNILLO Ø5/16" x 4-1/2"L 	8 PCS
B	HALF MOON WASHER / BOULON DEMI-LUNE / RONDANA DE MEDIA LUNA M8x30x15x8mm 	8 PCS
C	NUT/ ÉCROU/ NUEZ Ø5/16"x12x6mm 	8 PCS
D	FLAT WASHER/ RONDELLE PLATE/ ARANDELA PLANA Ø5/16"x19x2mm 	18 PCS
E	LOCK WASHER/ RONDELLE DE BLOCAGE/ARANDELA DE BLOQUEO Ø5/16"x12x2mm 	18 PCS
F	WRENCH/ CLÉ/ LLAVE INGLESA M12 	1 PC
G	BOLT/ BOULON/ TORNILLO Ø5/16" x 1-1/2"L 	10 PCS
H	SCREW/ VIS/ TORNILLO M4 x 1"L 	8 PCS

LIST OF PARTS AND HARDWARE/ LISTE DES PIÈCES ET DU MATÉRIEL/ LISTA DE PIEZAS Y HARDWARE

NO#/ NOMBRE/ NÚMERO	DESCRIPTION/ DESCRIPTION/ DESCRIPCIÓN	QUANTITY/ QUANTITÉ/ CANTIDAD
1	HEADBOARD PANEL/ PANNEAU DE TÊTE DE LIT/ PANEL DE CABECERO 	1 PC
2L	LEFT HEADBOARD LEG/ PIED DE TÊTE DE LIT GAUCHE/ PIERNA IZQUIERDA DE LA CABECERA 	1 PC
2R	RIGHT HEADBOARD LEG/ PIED DE TÊTE DE LIT DROIT/ PATA DERECHA DE LA CABECERA 	1 PC
3	MENDING PLATE/ PLAQUE DE RÉPARATION/ PLATO DE REPARACIÓN 	2 PCS
4	FOOTBOARD/ PIED DE LIT/ ESTRIBO 	1 PC
5	SIDE RAIL/ RAIL LATÉRAL/ CARRIL LATERAL 	2 PCS
6	SLAT/ LATTE/ LISTÓN 1545x76x18mm 	4 PCS
7	LEG SUPPORT SLAT / JAMBE D'APPUI/ PIERNA DE APOYO 251x34x34mm 	4 PCS

NOTE:
ASSEMBLE UNIT ON A SOFT SURFACE.
ASSEMBLEZ L'UNITÉ SUR UNE SURFACE MOLLE.
ENSAMBLE LA UNIDAD EN UNA SUPERFICIE PLANA Y SUAVE.

DO NOT TIGHTEN BOLTS UNTIL ALL PARTS AND HARDWARE OF THE UNIT ARE ASSEMBLED.
NE SERREZ PAS LES BOULONS JUSQU'À CE QUE L'UNITÉ SOIT COMPLÈTEMENT ASSEMBLÉE.
NO APRIETE LOS TORNILLOS HASTA QUE LA UNIDAD ESTE COMPLETAMENTE ENSAMBLADA.



WARNING:
ONLY USE THE HAND TOOLS PROVIDED

ASSEMBLY INSTRUCTIONS INSTRUCTIONS DE MONTAGE INSTRUCCIONES DE MONTAJE

QUEEN PANEL BED HEADBOARD
QUEEN PANEL BED FOOTBOARD
QUEEN/KING PANEL BED RAILS

Note:

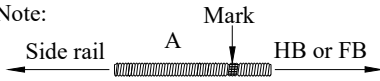

Step/ Étape/ Paso 1

Step/ Étape/ Paso 2

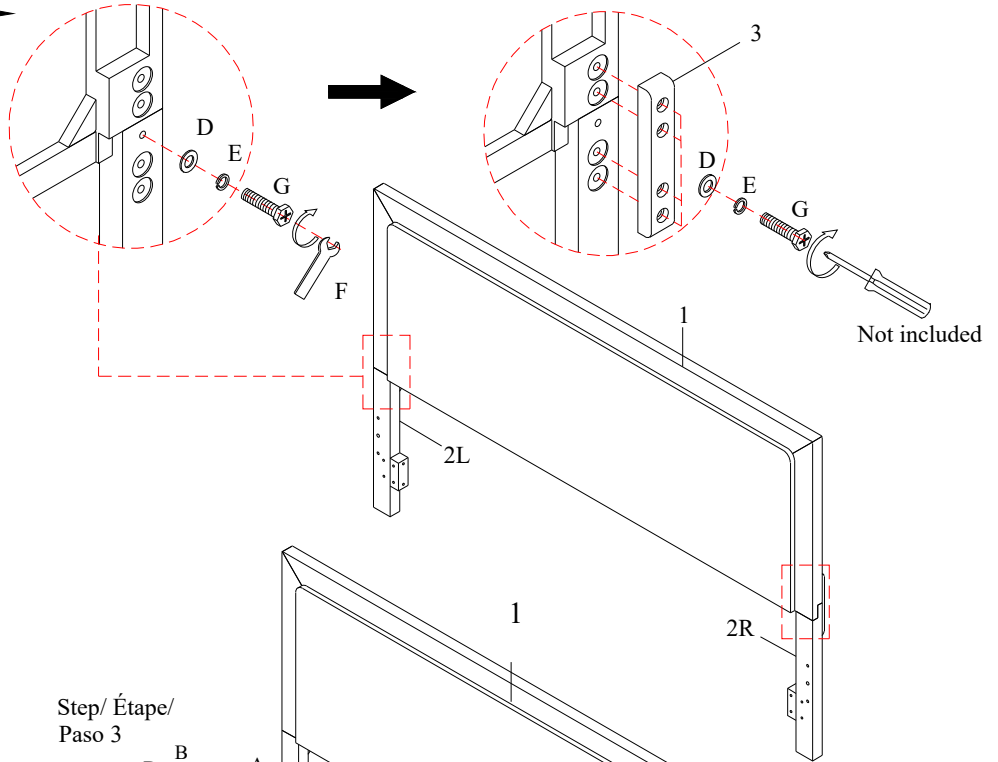

Not included

Not included

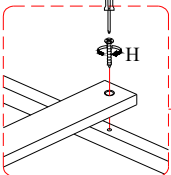

Step/ Étape/ Paso 5

Step/ Étape/
Paso 3

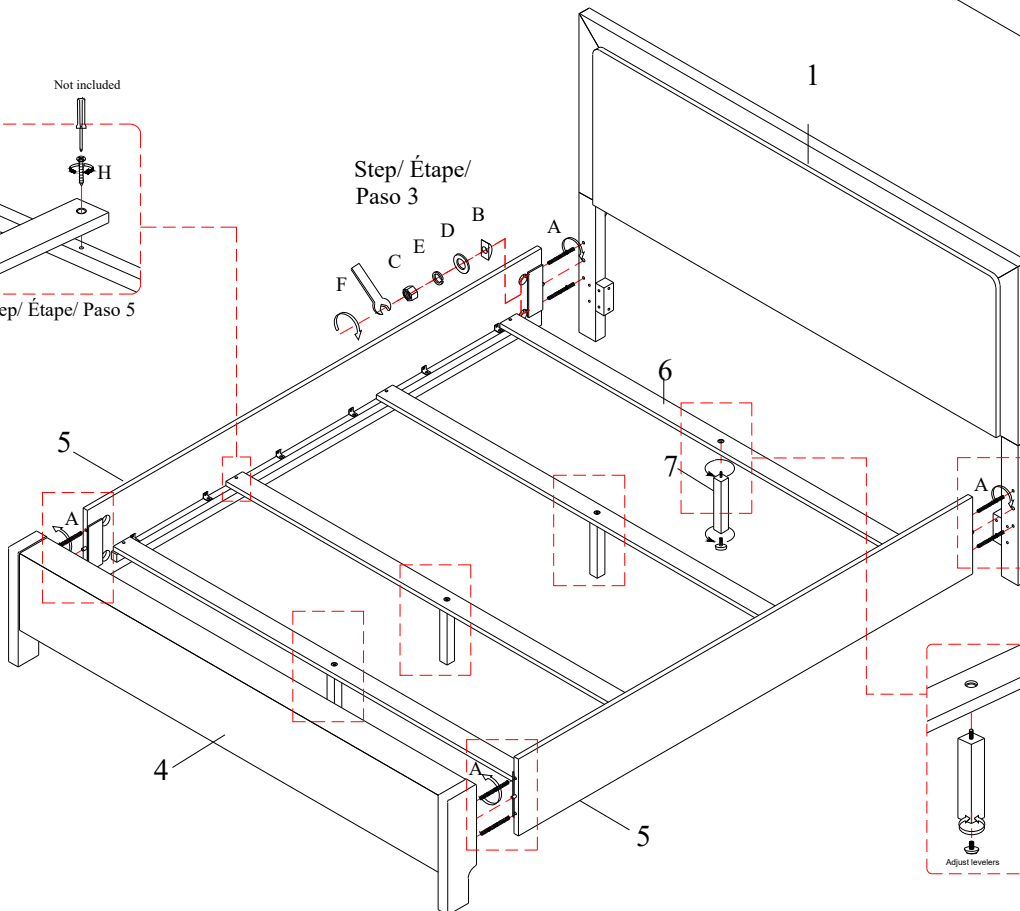
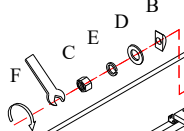

Step/ Étape/ Paso 4

Adjust levelers

NOTE:

Spirit level not included but necessary to level product on floor.

Niveau à bulle non inclus mais nécessaire pour niveler le produit au sol.

Nivel de burbuja no incluido pero necesario para nivelar el producto en el piso.



WARNING:
ONLY USE THE HAND
TOOLS PROVIDED

ASSEMBLY INSTRUCTIONS INSTRUCTIONS DE MONTAGE INSTRUCCIONES DE MONTAJE

QUEEN PANEL BED HEADBOARD
QUEEN PANEL BED STORAGE FOOTBOARD
QUEEN/KING PANEL BED RAILS









CAUTION: PLEASE READ ALL INSTRUCTIONS BEFORE STARTING THE ASSEMBLY OF THIS PRODUCT. THESE PIECES ARE HEAVY. IN ORDER TO PREVENT PERSONAL INJURY AND ENSURE THAT THIS PRODUCT IS NOT DAMAGED DURING THE ASSEMBLY PROCESS, IT IS STRONGLY RECOMMENDED TO ENLIST THE ASSISTANCE OF ONE OR MORE PERSONS. IN CASE OF EXCESS STAIN, WIPE THE BOTTOM OF THE UNIT BEFORE PLACING ON ANY SURFACE.

ATTENTION: VEUILLEZ LIRE TOUTES LES INSTRUCTIONS AVANT DE COMMENCER L'ASSEMBLAGE DE CE PRODUIT. LES PIÈCES SONT LOURDES. POUR ÉVITER TOUTE BLESSURE ET POUR VOUS ASSURER QUE LE PRODUIT N'EST PAS ENDOMMAGÉ PENDANT L'ASSEMBLAGE, NOUS VOUS RECOMMANDONS DE FAIRE APPEL À UNE OU PLUSIEURS AUTRES PERSONNES. EN CAS DE TACHE EXCESSIVE, ESSUYEZ LE FOND DE L'UNITÉ AVANT LE PLACEMENT SUR N'IMPORTE QUELLE SURFACE.









CUIDADO: FAVOR DE LEER TODAS LAS INSTRUCCIONES ANTES DE ENSAMBLAR SU PRODUCTO, ESTAS PIEZAS SON PESADAS. PARA PREVENIR HERIDAS PERSONALES Y ASEGURAR QUE SU PRODUCTO NO SEA DAÑADO MIENTRAS ES ENSAMBLADO. SE RECOMIENDA LA ASISTENCIA DE UNA O MÁS PERSONAS.

WARNING: PROTECTIVE GLIDE IS PLACED UNDER EACH LEG OF THE FURNITURE TO RESIST SCRATCHES ON FLOOR SURFACE. SOME FLOOR SURFACES CAN BE EXTRA SENSITIVE TO SCRATCHES AND MARKINGS, IF YOU ARE NOT SURE CONSULT WITH YOUR DEALER. AVERTISSEMENT. LES PIEDS DES MEUBLES SONT MUNIS DE PATINS DESTINÉS À PROTÉGER LE PLANCHER. CERTAINS REVÊTEMENTS DE SOL PEUVENT ÊTRE TRÈS FRAGILES. EN CAS DE DOUTE. CONSULTER LE MARCHAND.

LIST OF PARTS AND HARDWARE/ LISTE DES PIÈCES ET DU MATÉRIEL/ LISTA DE PIEZAS Y HARDWARE

NO#/ NOMBRE/ NÚMERO	DESCRIPTION/ DESCRIPTION/ DESCRIPCIÓN	QUANTITY/ QUANTITÉ/ CANTIDAD
A	BOLT/ BOULON/ TORNILLO Ø5/16" x 4-1/2"L 	8 PCS
B	HALF MOON WASHER / BOULON DEMI-LUNE / RONDANA DE MEDIA LUNA M8x30x15x8mm 	8 PCS
C	NUT/ ÉCROU/ NUEZ Ø5/16"x12x6mm 	8 PCS
D	FLAT WASHER/ RONDELLE PLATE/ ARANDELA PLANA Ø5/16"x19x2mm 	18 PCS
E	LOCK WASHER/ RONDELLE DE BLOCAGE/ARANDELA DE BLOQUEO Ø5/16"x12x2mm 	18 PCS
F	WRENCH/ CLÉ/ LLAVE INGLESA M12 	1 PC
G	BOLT/ BOULON/ TORNILLO Ø5/16" x 1-1/2"L 	10 PCS
H	SCREW/ VIS/ TORNILLO M4 x 1"L 	28 PCS

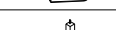
LIST OF PARTS AND HARDWARE/ LISTE DES PIÈCES ET DU MATÉRIEL/ LISTA DE PIEZAS Y HARDWARE

NO#/ NOMBRE/ NÚMERO	DESCRIPTION/ DESCRIPTION/ DESCRIPCIÓN	QUANTITY/ QUANTITÉ/ CANTIDAD
1	HEADBOARD PANEL/ PANNEAU DE TÊTE DE LIT/ PANEL DE CABECERO 	1 PC
2L	LEFT HEADBOARD LEG/ PIED DE TÊTE DE LIT GAUCHE/ PIERNA IZQUIERDA DE LA CABECERA 	1 PC
2R	RIGHT HEADBOARD LEG/ PIED DE TÊTE DE LIT DROIT/ PATA DERECHA DE LA CABECERA 	1 PC
3	MENDING PLATE/ PLAQUE DE RÉPARATION/ PLATO DE REPARACIÓN 	2 PCS
4	STORAGE FOOTBOARD / MARCHEPIED DE RANGEMENT/ PIE DE CAMA DE ALMACENAMIENTO 	1 PC
5	SIDE RAIL/ RAIL LATÉRAL/ CARRIL LATERAL 	2 PCS
6	SLAT SUPPORT/ SUPPORT DE LATTES/ SOPORTE DE LÁMINAS 985x88x18mm(4 Pcs) 	2 SET
7	LEG SUPPORT SLAT / JAMBE D'APPUI/ PIERNA DE APOYO 369x34x34mm 	6 PCS
8	SLAT ROLL/ROULEAU DE LATTES/ ROLLO DE LAMAS Included 13pcs (1545mm) 	1 SET

NOTE:
ASSEMBLE UNIT ON A SOFT SURFACE.
ASSEMBLEZ L'UNITÉ SUR UNE SURFACE MOLLE.
ENSAMBLE LA UNIDAD EN UNA SUPERFICIE PLANA Y SUAVE.

DO NOT TIGHTEN BOLTS UNTIL ALL PARTS AND HARDWARE OF THE UNIT ARE ASSEMBLED.
NE SERREZ PAS LES BOULONS JUSQU'À CE QUE L'UNITÉ SOIT COMPLÈTEMENT ASSEMBLÉE.
NO APRIETE LOS TORNILLOS HASTA QUE LA UNIDAD ESTE COMPLETAMENTE ENSAMBLADA.



WARNING:
ONLY USE THE HAND TOOLS PROVIDED

ASSEMBLY INSTRUCTIONS INSTRUCTIONS DE MONTAGE INSTRUCCIONES DE MONTAJE

QUEEN PANEL BED HEADBOARD
QUEEN PANEL BED STORAGE FOOTBOARD
QUEEN/KING PANEL BED RAILS

Note:

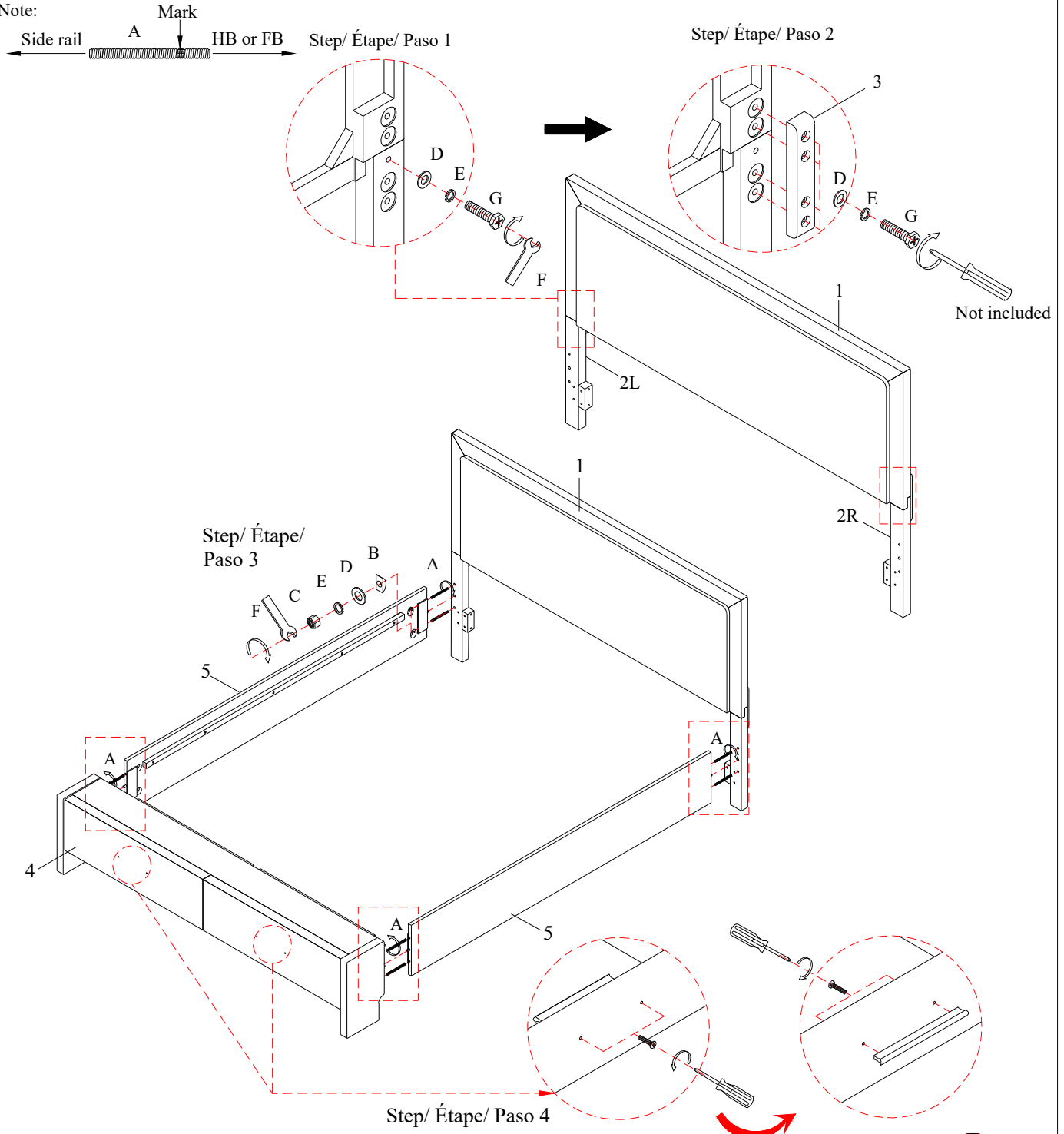

NOTE:

Spirit level not included but necessary to level product on floor.

Niveau à bulle non inclus mais nécessaire pour niveler le produit au sol.

Nivel de burbuja no incluido pero necesario para nivelar el producto en el piso.



WARNING:
ONLY USE THE HAND
TOOLS PROVIDED

ASSEMBLY INSTRUCTIONS INSTRUCTIONS DE MONTAGE INSTRUCCIONES DE MONTAJE

QUEEN PANEL BED HEADBOARD
QUEEN PANEL BED STORAGE FOOTBOARD
QUEEN/KING PANEL BED RAILS

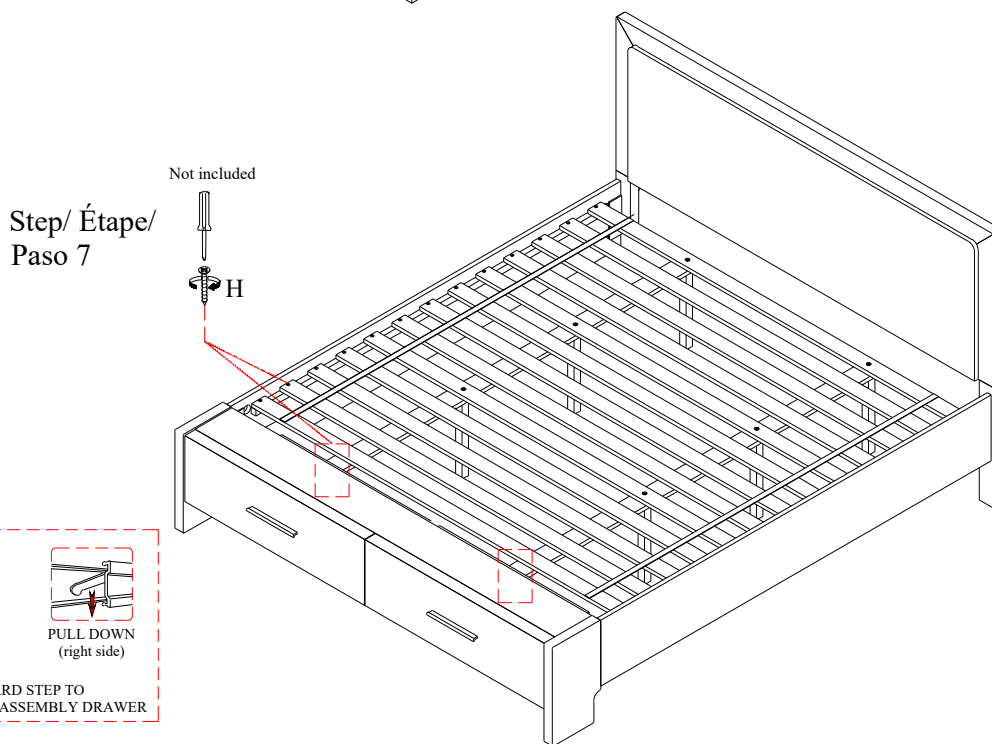
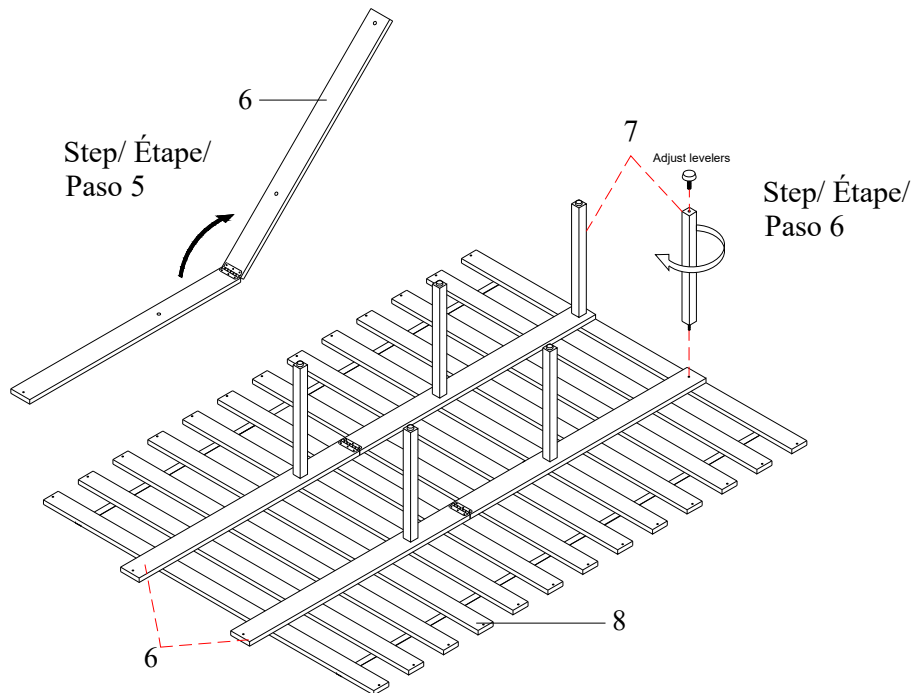

NOTE:

Spirit level not included but necessary to level product on floor.

Niveau à bulle non inclus mais nécessaire pour niveler le produit au sol.

Nivel de burbuja no incluido pero necesario para nivelar el producto en el piso.



WARNING:
ONLY USE THE HAND
TOOLS PROVIDED

ASSEMBLY INSTRUCTIONS INSTRUCTIONS DE MONTAGE INSTRUCCIONES DE MONTAJE

KING PANEL BED HEADBOARD
KING PANEL BED FOOTBOARD
QUEEN/KING PANEL BED RAILS







CAUTION: PLEASE READ ALL INSTRUCTIONS BEFORE STARTING THE ASSEMBLY OF THIS PRODUCT. THESE PIECES ARE HEAVY. IN ORDER TO PREVENT PERSONAL INJURY AND ENSURE THAT THIS PRODUCT IS NOT DAMAGED DURING THE ASSEMBLY PROCESS, IT IS STRONGLY RECOMMENDED TO ENLIST THE ASSISTANCE OF ONE OR MORE PERSONS. IN CASE OF EXCESS STAIN, WIPE THE BOTTOM OF THE UNIT BEFORE PLACING ON ANY SURFACE.

ATTENTION: VEUILLEZ LIRE TOUTES LES INSTRUCTIONS AVANT DE COMMENCER L'ASSEMBLAGE DE CE PRODUIT. LES PIÈCES SONT LOURDES. POUR ÉVITER TOUTE BLESSURE ET POUR VOUS ASSURER QUE LE PRODUIT N'EST PAS ENDOMMAGÉ PENDANT L'ASSEMBLAGE, NOUS VOUS RECOMMANDONS DE FAIRE APPEL À UNE OU PLUSIEURS AUTRES PERSONNES. EN CAS DE TACHE EXCESSIVE, ESSUYEZ LE FOND DE L'UNITÉ AVANT LE PLACEMENT SUR N'IMPORTE QUELLE SURFACE.





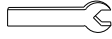



CUIDADO: FAVOR DE LEER TODAS LAS INSTRUCCIONES ANTES DE ENSAMBLAR SU PRODUCTO, ESTAS PIEZAS SON PESADAS. PARA PREVENIR HERIDAS PERSONALES Y ASEGURAR QUE SU PRODUCTO NO SEA DAÑADO MIENTRAS ES ENSAMBLADO. SE RECOMIENDA LA ASISTENCIA DE UNA O MÁS PERSONAS.

WARNING: PROTECTIVE GLIDE IS PLACED UNDER EACH LEG OF THE FURNITURE TO RESIST SCRATCHES ON FLOOR SURFACE. SOME FLOOR SURFACES CAN BE EXTRA SENSITIVE TO SCRATCHES AND MARKINGS, IF YOU ARE NOT SURE CONSULT WITH YOUR DEALER. AVERTISSEMENT. LES PIEDS DES MEUBLES SONT MUNIS DE PATINS DESTINÉS À PROTÉGER LE PLANCHER. CERTAINS REVÊTEMENTS DE SOL PEUVENT ÊTRE TRÈS FRAGILES. EN CAS DE DOUTE. CONSULTER LE MARCHAND.

LIST OF PARTS AND HARDWARE/ LISTE DES PIÈCES ET DU MATÉRIEL/ LISTA DE PIEZAS Y HARDWARE

NO#/ NOMBRE/ NÚMERO	DESCRIPTION/ DESCRIPTION/ DESCRIPCIÓN	QUANTITY/ QUANTITÉ/ CANTIDAD
A	BOLT/ BOULON/ TORNILLO Ø5/16" x 4-1/2"L 	8 PCS
B	HALF MOON WASHER / BOULON DEMI-LUNE / RONDANA DE MEDIA LUNA M8x30x15x8mm 	8 PCS
C	NUT/ ÉCROU/ NUEZ Ø5/16"x12x6mm 	8 PCS
D	FLAT WASHER/ RONDELLE PLATE/ ARANDELA PLANA Ø5/16"x19x2mm 	18 PCS
E	LOCK WASHER/ RONDELLE DE BLOCAGE/ARANDELA DE BLOQUEO Ø5/16"x12x2mm 	18 PCS
F	WRENCH/ CLÉ/ LLAVE INGLESA M12 	1 PC
G	BOLT/ BOULON/ TORNILLO Ø5/16" x 1-1/2"L 	10 PCS
H	SCREW/ VIS/ TORNILLO M4 x 1"L 	8 PCS

LIST OF PARTS AND HARDWARE/ LISTE DES PIÈCES ET DU MATÉRIEL/ LISTA DE PIEZAS Y HARDWARE

NO#/ NOMBRE/ NÚMERO	DESCRIPTION/ DESCRIPTION/ DESCRIPCIÓN	QUANTITY/ QUANTITÉ/ CANTIDAD
1	HEADBOARD PANEL/ PANNEAU DE TÊTE DE LIT/ PANEL DE CABECERO 	1 PC
2L	LEFT HEADBOARD LEG/ PIED DE TÊTE DE LIT GAUCHE/ PIERNA IZQUIERDA DE LA CABECERA 	1 PC
2R	RIGHT HEADBOARD LEG/ PIED DE TÊTE DE LIT DROIT/ PATA DERECHA DE LA CABECERA 	1 PC
3	MENDING PLATE/ PLAQUE DE RÉPARATION/ PLATO DE REPARACIÓN 	2 PCS
4	FOOTBOARD/ PIED DE LIT/ ESTRIBO 	1 PC
5	SIDE RAIL/ RAIL LATÉRAL/ CARRIL LATERAL 	2 PCS
6	SLAT/ LATTE/ LISTÓN 1952x76x18mm 	4 PCS
7	LEG SUPPORT SLAT / JAMBE D'APPUI/ PIERNA DE APOYO 251x34x34mm 	8 PCS

NOTE:
ASSEMBLE UNIT ON A SOFT SURFACE.
ASSEMBLEZ L'UNITÉ SUR UNE SURFACE MOLLE.
ENSAMBLE LA UNIDAD EN UNA SUPERFICIE PLANA Y SUAVE.

DO NOT TIGHTEN BOLTS UNTIL ALL PARTS AND HARDWARE OF THE UNIT ARE ASSEMBLED.
NE SERREZ PAS LES BOULONS JUSQU'À CE QUE L'UNITÉ SOIT COMPLÈTEMENT ASSEMBLÉE.
NO APRIETE LOS TORNILLOS HASTA QUE LA UNIDAD ESTE COMPLETAMENTE ENSAMBLADA.



WARNING:
ONLY USE THE HAND TOOLS PROVIDED

ASSEMBLY INSTRUCTIONS INSTRUCTIONS DE MONTAGE INSTRUCCIONES DE MONTAJE

KING PANEL BED HEADBOARD
KING PANEL BED FOOTBOARD
QUEEN/KING PANEL BED RAILS

Note:

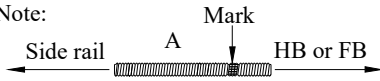

Step/ Étape/ Paso 1

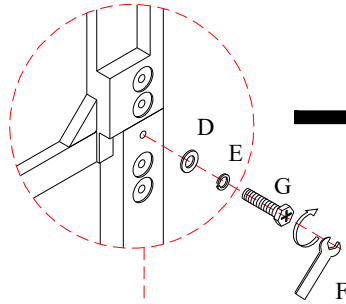

Step/ Étape/ Paso 2

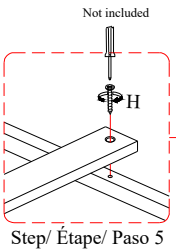
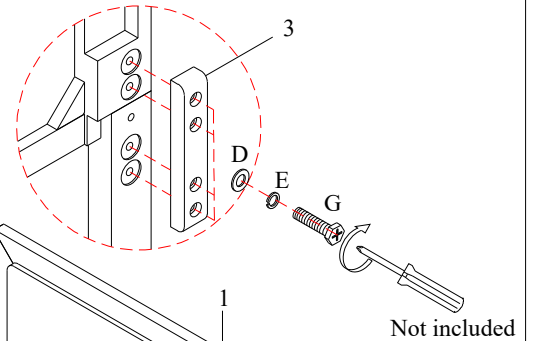

Step/ Étape/
Paso 3

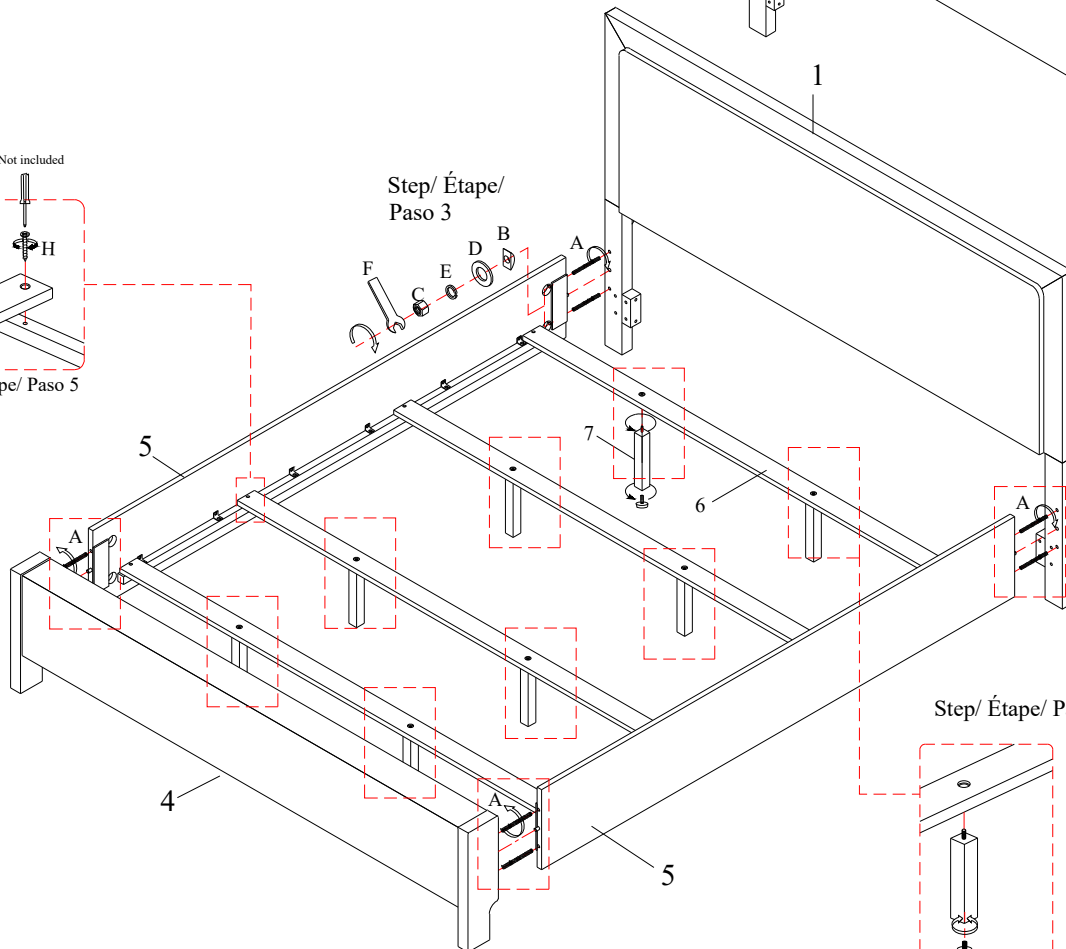
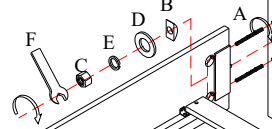

Step/ Étape/ Paso 4

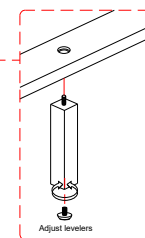

NOTE:

Spirit level not included but necessary to level product on floor.
Niveau à bulle non inclus mais nécessaire pour niveler le produit au sol.
Nivel de burbuja no incluido pero necesario para nivelar el producto en el piso.



WARNING:
ONLY USE THE HAND
TOOLS PROVIDED

ASSEMBLY INSTRUCTIONS INSTRUCTIONS DE MONTAGE INSTRUCCIONES DE MONTAJE

KING PANEL BED HEADBOARD
KING PANEL BED STORAGE FOOTBOARD
QUEEN/KING PANEL BED RAILS









CAUTION: PLEASE READ ALL INSTRUCTIONS BEFORE STARTING THE ASSEMBLY OF THIS PRODUCT. THESE PIECES ARE HEAVY. IN ORDER TO PREVENT PERSONAL INJURY AND ENSURE THAT THIS PRODUCT IS NOT DAMAGED DURING THE ASSEMBLY PROCESS, IT IS STRONGLY RECOMMENDED TO ENLIST THE ASSISTANCE OF ONE OR MORE PERSONS. IN CASE OF EXCESS STAIN, WIPE THE BOTTOM OF THE UNIT BEFORE PLACING ON ANY SURFACE.

ATTENTION: VEUILLEZ LIRE TOUTES LES INSTRUCTIONS AVANT DE COMMENCER L'ASSEMBLAGE DE CE PRODUIT. LES PIÉCES SONT LOURDES. POUR ÉVITER TOUTE BLESSURE ET POUR VOUS ASSURER QUE LE PRODUIT N'EST PAS ENDOMMAGÉ PENDANT L'ASSEMBLAGE, NOUS VOUS RECOMMANDONS DE FAIRE APPEL À UNE OU PLUSIEURS AUTRES PERSONNES. EN CAS DE TACHE EXCESSIVE, ESSUYEZ LE FOND DE L'UNITÉ AVANT LE PLACEMENT SUR N'IMPORTE QUELLE SURFACE.









CUIDADO: FAVOR DE LEER TODAS LAS INSTRUCCIONES ANTES DE ENSAMBLAR SU PRODUCTO, ESTAS PIEZAS SON PESADAS. PARA PREVENIR HERIDAS PERSONALES Y ASEGURAR QUE SU PRODUCTO NO SEA DAÑADO MIENTRAS ES ENSAMBLADO. SE RECOMIENDA LA ASISTENCIA DE UNA O MÁS PERSONAS.

WARNING: PROTECTIVE GLIDE IS PLACED UNDER EACH LEG OF THE FURNITURE TO RESIST SCRATCHES ON FLOOR SURFACE. SOME FLOOR SURFACES CAN BE EXTRA SENSITIVE TO SCRATCHES AND MARKINGS, IF YOU ARE NOT SURE CONSULT WITH YOUR DEALER. AVERTISSEMENT. LES PIEDS DES MEUBLES SONT MUNIS DE PATINS DESTINÉS À PROTÉGER LE PLANCHER. CERTAINS REVÊTEMENTS DE SOL PEUVENT ÊTRE TRÈS FRAGILES. EN CAS DE DOUTE. CONSULTER LE MARCHAND.

LIST OF PARTS AND HARDWARE/ LISTE DES PIÈCES ET DU MATÉRIEL/ LISTA DE PIEZAS Y HARDWARE

NO#/ NOMBRE/ NÚMERO	DESCRIPTION/ DESCRIPTION/ DESCRIPCIÓN	QUANTITY/ QUANTITÉ/ CANTIDAD
A	BOLT/ BOULON/ TORNILLO Ø5/16" x 4-1/2"L 	8 PCS
B	HALF MOON WASHER / BOULON DEMI-LUNE / RONDANA DE MEDIA LUNA M8x30x15x8mm 	8 PCS
C	NUT/ ÉCROU/ NUEZ Ø5/16"x12x6mm 	8 PCS
D	FLAT WASHER/ RONDELLE PLATE/ ARANDELA PLANA Ø5/16"x19x2mm 	18 PCS
E	LOCK WASHER/ RONDELLE DE BLOCAGE/ARANDELA DE BLOQUEO Ø5/16"x12x2mm 	18 PCS
F	WRENCH/ CLÉ/ LLAVE INGLESA M12 	1 PC
G	BOLT/ BOULON/ TORNILLO Ø5/16" x 1-1/2"L 	10 PCS
H	SCREW/ VIS/ TORNILLO M4 x 1"L 	29 PCS

LIST OF PARTS AND HARDWARE/ LISTE DES PIÈCES ET DU MATÉRIEL/ LISTA DE PIEZAS Y HARDWARE

NO#/ NOMBRE/ NÚMERO	DESCRIPTION/ DESCRIPTION/ DESCRIPCIÓN	QUANTITY/ QUANTITÉ/ CANTIDAD
1	HEADBOARD PANEL/ PANNEAU DE TÊTE DE LIT/ PANEL DE CABECERO 	1 PC
2L	LEFT HEADBOARD LEG/ PIED DE TÊTE DE LIT GAUCHE/ PIERNA IZQUIERDA DE LA CABECERA 	1 PC
2R	RIGHT HEADBOARD LEG/ PIED DE TÊTE DE LIT DROIT/ PATA DERECHA DE LA CABECERA 	1 PC
3	MENDING PLATE/ PLAQUE DE RÉPARATION/ PLATO DE REPARACIÓN 	2 PCS
4	STORAGE FOOTBOARD / MARCHEPIED DE RANGEMENT/ PIE DE CAMA DE ALMACENAMIENTO 	1 PC
5	SIDE RAIL/ RAIL LATÉRAL/ CARRIL LATERAL 	2 PCS
6	SLAT SUPPORT/ SUPPORT DE LATTES/ SOPORTE DE LÁMINAS 1970x88x18mm 	3 PCS
7	LEG SUPPORT SLAT / JAMBE D'APPUI/ PIERNA DE APOYO 369x34x34mm 	9 PCS
8	SLAT ROLL/ROULEAU DE LATTES/ ROLLO DE LAMAS Included 13pcs (1952mm) 	1 SET

NOTE:
ASSEMBLE UNIT ON A SOFT SURFACE.
ASSEMBLEZ L'UNITÉ SUR UNE SURFACE MOLLE.
ENSAMBLE LA UNIDAD EN UNA SUPERFICIE PLANA Y SUAVE.

DO NOT TIGHTEN BOLTS UNTIL ALL PARTS AND HARDWARE OF THE UNIT ARE ASSEMBLED.
NE SERREZ PAS LES BOULONS JUSQU'À CE QUE L'UNITÉ SOIT COMPLÈTEMENT ASSEMBLÉE.
NO APRIETE LOS TORNILLOS HASTA QUE LA UNIDAD ESTE COMPLETAMENTE ENSAMBLADA.



WARNING:
ONLY USE THE HAND TOOLS PROVIDED

ASSEMBLY INSTRUCTIONS INSTRUCTIONS DE MONTAGE INSTRUCCIONES DE MONTAJE

KING PANEL BED HEADBOARD
KING PANEL BED STORAGE FOOTBOARD
QUEEN/KING PANEL BED RAILS

Note:

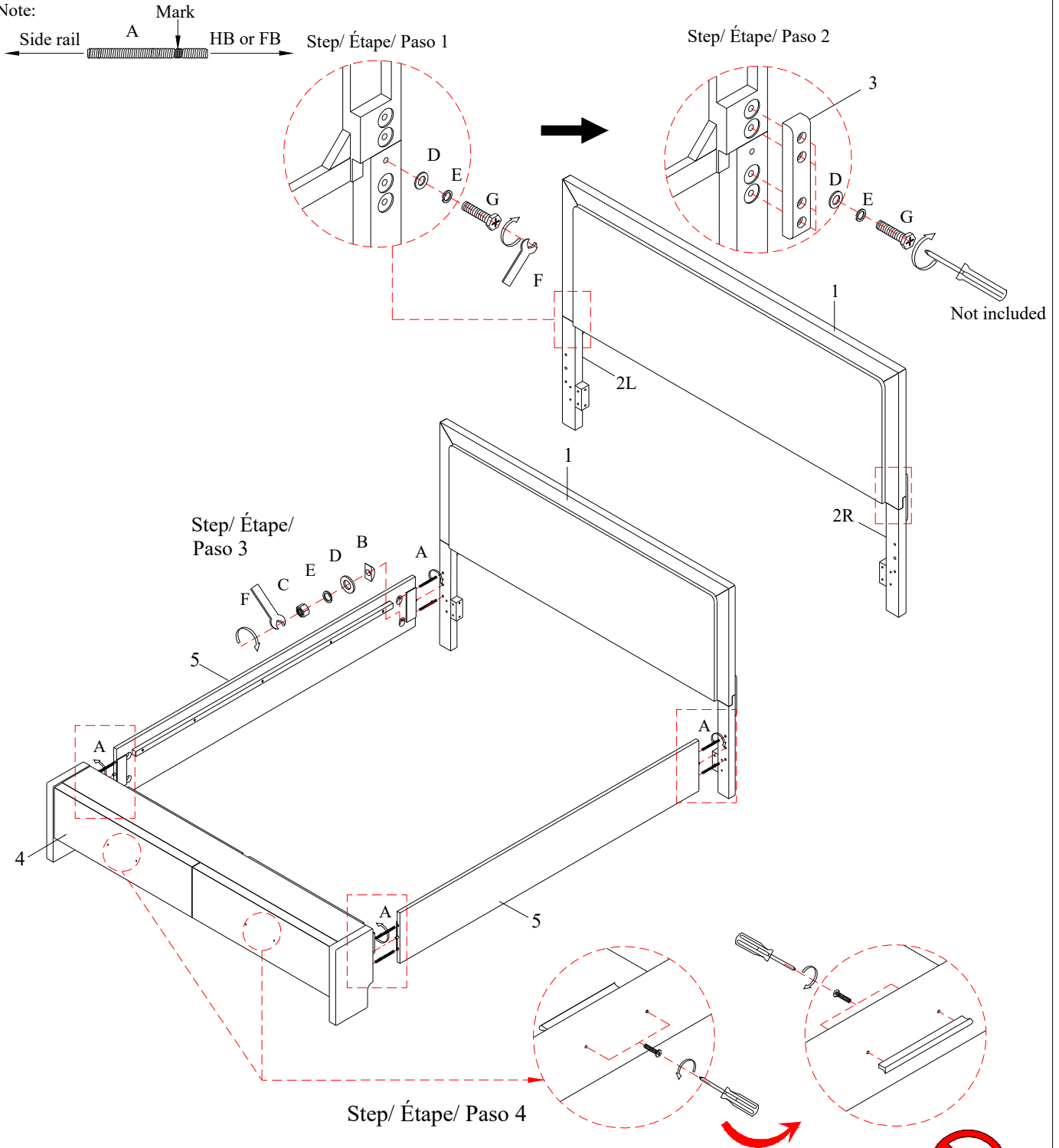

NOTE:

Spirit level not included but necessary to level product on floor.

Niveau à bulle non inclus mais nécessaire pour niveler le produit au sol.

Nivel de burbuja no incluido pero necesario para nivelar el producto en el piso.



WARNING:
ONLY USE THE HAND
TOOLS PROVIDED

ASSEMBLY INSTRUCTIONS INSTRUCTIONS DE MONTAGE INSTRUCCIONES DE MONTAJE

KING PANEL BED HEADBOARD
KING PANEL BED STORAGE FOOTBOARD
QUEEN/KING PANEL BED RAILS

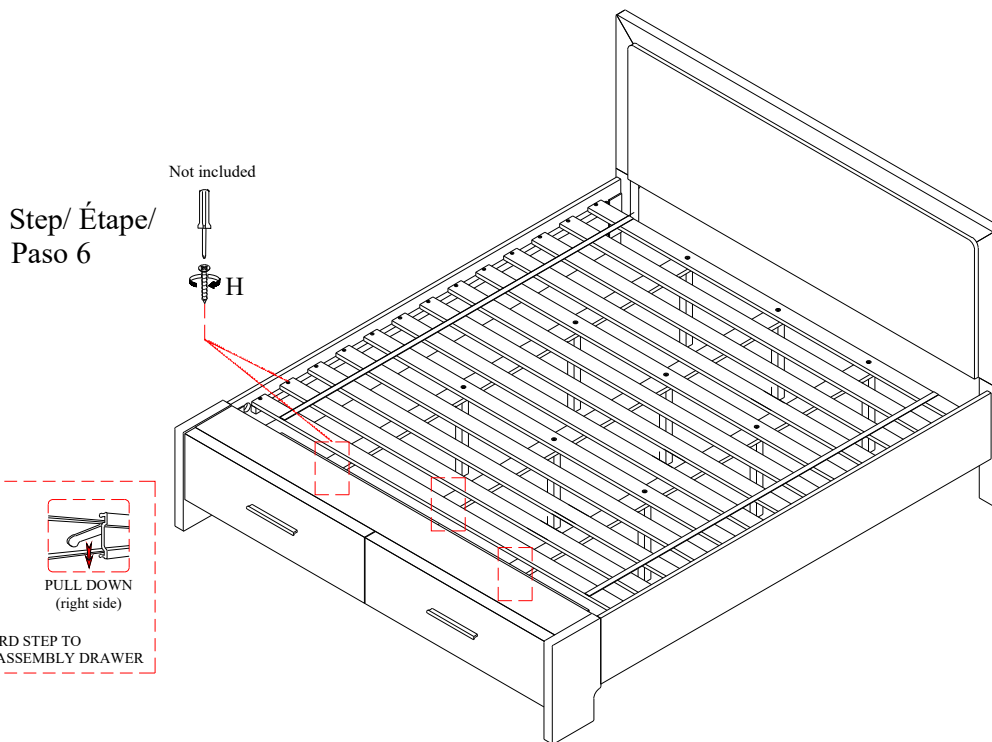
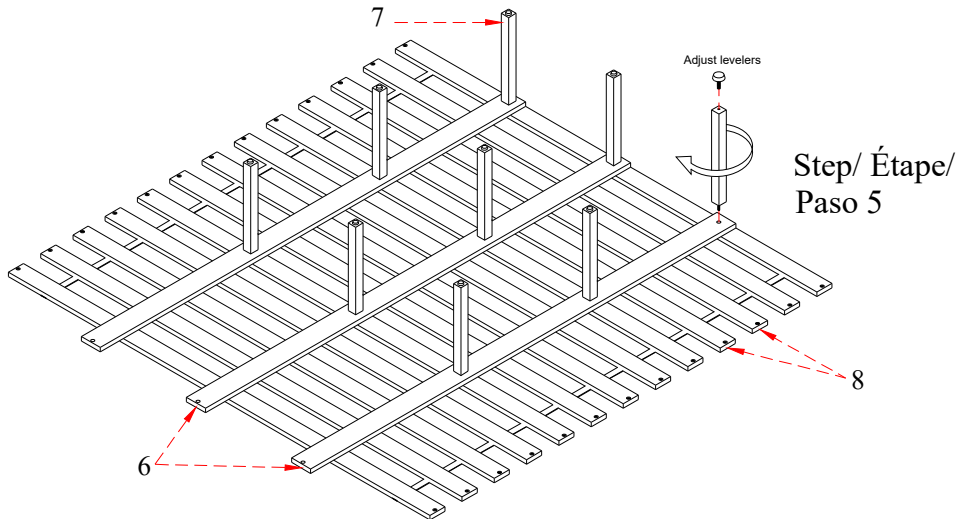

NOTE:

Spirit level not included but necessary to level product on floor.

Niveau à bulle non inclus mais nécessaire pour niveler le produit au sol.

Nivel de burbuja no incluido pero necesario para nivelar el producto en el piso.



WARNING:
ONLY USE THE HAND
TOOLS PROVIDED

ASSEMBLY INSTRUCTIONS INSTRUCTIONS DE MONTAGE INSTRUCCIONES DE MONTAJE

KING PANEL BED HEADBOARD
KING PANEL BED FOOTBOARD
CAL.KING PANEL BED RAILS











CAUTION: PLEASE READ ALL INSTRUCTIONS BEFORE STARTING THE ASSEMBLY OF THIS PRODUCT. THESE PIECES ARE HEAVY. IN ORDER TO PREVENT PERSONAL INJURY AND ENSURE THAT THIS PRODUCT IS NOT DAMAGED DURING THE ASSEMBLY PROCESS, IT IS STRONGLY RECOMMENDED TO ENLIST THE ASSISTANCE OF ONE OR MORE PERSONS. IN CASE OF EXCESS STAIN, WIPE THE BOTTOM OF THE UNIT BEFORE PLACING ON ANY SURFACE.

ATTENTION: VEUILLEZ LIRE TOUTES LES INSTRUCTIONS AVANT DE COMMENCER L'ASSEMBLAGE DE CE PRODUIT. LES PIÉCES SONT LOURDES. POUR ÉVITER TOUTE BLESSURE ET POUR VOUS ASSURER QUE LE PRODUIT N'EST PAS ENDOMMAGÉ PENDANT L'ASSEMBLAGE, NOUS VOUS RECOMMANDONS DE FAIRE APPEL À UNE OU PLUSIEURS AUTRES PERSONNES. EN CAS DE TACHE EXCESSIVE, ESSUYEZ LE FOND DE L'UNITÉ AVANT LE PLACEMENT SUR N'IMPORTE QUELLE SURFACE.





CUIDADO: FAVOR DE LEER TODAS LAS INSTRUCCIONES ANTES DE ENSAMBLAR SU PRODUCTO, ESTAS PIEZAS SON PESADAS. PARA PREVENIR HERIDAS PERSONALES Y ASEGURAR QUE SU PRODUCTO NO SEA DAÑADO MIENTRAS ES ENSAMBLADO. SE RECOMIENDA LA ASISTENCIA DE UNA O MÁS PERSONAS.

WARNING: PROTECTIVE GLIDE IS PLACED UNDER EACH LEG OF THE FURNITURE TO RESIST SCRATCHES ON FLOOR SURFACE. SOME FLOOR SURFACES CAN BE EXTRA SENSITIVE TO SCRATCHES AND MARKINGS, IF YOU ARE NOT SURE CONSULT WITH YOUR DEALER. AVERTISSEMENT. LES PIEDS DES MEUBLES SONT MUNIS DE PATINS DESTINÉS À PROTÉGER LE PLANCHER. CERTAINS REVÊTEMENTS DE SOL PEUVENT ÊTRE TRÈS FRAGILES. EN CAS DE DOUTE. CONSULTER LE MARCHAND.

LIST OF PARTS AND HARDWARE/ LISTE DES PIÈCES ET DU MATÉRIEL/ LISTA DE PIEZAS Y HARDWARE

NO#/ NOMBRE/ NÚMERO	DESCRIPTION/ DESCRIPTION/ DESCRIPCIÓN	QUANTITY/ QUANTITÉ/ CANTIDAD
A	BOLT/ BOULON/ TORNILLO Ø5/16" x 4-1/2"L 	8 PCS
B	HALF MOON WASHER / BOULON DEMI-LUNE / RONDANA DE MEDIA LUNA M8x30x15x8mm 	8 PCS
C	NUT/ ÉCROU/ NUEZ Ø5/16"x12x6mm 	8 PCS
D	FLAT WASHER/ RONDELLE PLATE/ ARANDELA PLANA Ø5/16"x19x2mm 	18 PCS
E	LOCK WASHER/ RONDELLE DE BLOCAGE/ARANDELA DE BLOQUEO Ø5/16"x12x2mm 	18 PCS
F	WRENCH/ CLÉ/ LLAVE INGLESA M12 	1 PC
G	BOLT/ BOULON/ TORNILLO Ø5/16" x 1-1/2"L 	10 PCS
H	SCREW/ VIS/ TORNILLO M4 x 1"L 	8 PCS
I	BOLT/ BOULON/ TORNILLO Ø1/4" x 1-3/4"L 	6 PCS
J	ALLEN KEY/ CLÉ ALLEN/ LLAVE INGLESA ALLEN M4 	1 PC

LIST OF PARTS AND HARDWARE/ LISTE DES PIÈCES ET DU MATÉRIEL/ LISTA DE PIEZAS Y HARDWARE

NO#/ NOMBRE/ NÚMERO	DESCRIPTION/ DESCRIPTION/ DESCRIPCIÓN	QUANTITY/ QUANTITÉ/ CANTIDAD
1	HEADBOARD PANEL/ PANNEAU DE TÊTE DE LIT/ PANEL DE CABECERO 	1 PC
2L	LEFT HEADBOARD LEG/ PIED DE TÊTE DE LIT GAUCHE/ PIERNA IZQUIERDA DE LA CABECERA 	1 PC
2R	RIGHT HEADBOARD LEG/ PIED DE TÊTE DE LIT DROIT/ PATA DERECHA DE LA CABECERA 	1 PC
3	MENDING PLATE/ PLAQUE DE RÉPARATION/ PLATO DE REPARACIÓN 	2 PCS
4	FOOTBOARD/ PIED DE LIT/ ESTRIBO 	1 PC

NOTE:
ASSEMBLE UNIT ON A SOFT SURFACE.
ASSEMBLEZ L'UNITÉ SUR UNE SURFACE MOLLE.
ENSAMBLE LA UNIDAD EN UNA SUPERFICIE PLANA Y SUAVE.

DO NOT TIGHTEN BOLTS UNTIL ALL PARTS AND HARDWARE OF THE UNIT ARE ASSEMBLED.
NE SERREZ PAS LES BOULONS JUSQU'À CE QUE L'UNITÉ SOIT COMPLÈTEMENT ASSEMBLÉE.
NO APRIETE LOS TORNILLOS HASTA QUE LA UNIDAD ESTE COMPLETAMENTE ENSAMBLADA.



WARNING:
ONLY USE THE HAND TOOLS PROVIDED

ASSEMBLY INSTRUCTIONS INSTRUCTIONS DE MONTAGE INSTRUCCIONES DE MONTAJE

KING PANEL BED HEADBOARD
KING PANEL BED FOOTBOARD
CAL.KING PANEL BED RAILS

LIST OF PARTS AND HARDWARE/ LISTE DES PIÈCES ET DU MATÉRIEL/ LISTA DE PIEZAS Y HARDWARE

NO#/ NOMBRE/ NÚMERO	DESCRIPTION/ DESCRIPTION/ DESCRIPCIÓN	QUANTITY/ QUANTITÉ/ CANTIDAD
5	CAL.KING SIDE RAIL/ RAIL LATÉRAL/ CARRIL LATERAL	2 PCS
6	SLAT/ LATTE/ LISTÓN 1952x76x18mm	4 PCS
7	LEG SUPPORT SLAT / JAMBE D'APPUI/ PIERNA DE APOYO 251x34x34mm	8 PCS
8	SITE RAIL CLEAT / TAQUET DE RAIL DE SITE/ LIMPIEZA DEL RIEL DEL SITIO	2 PCS

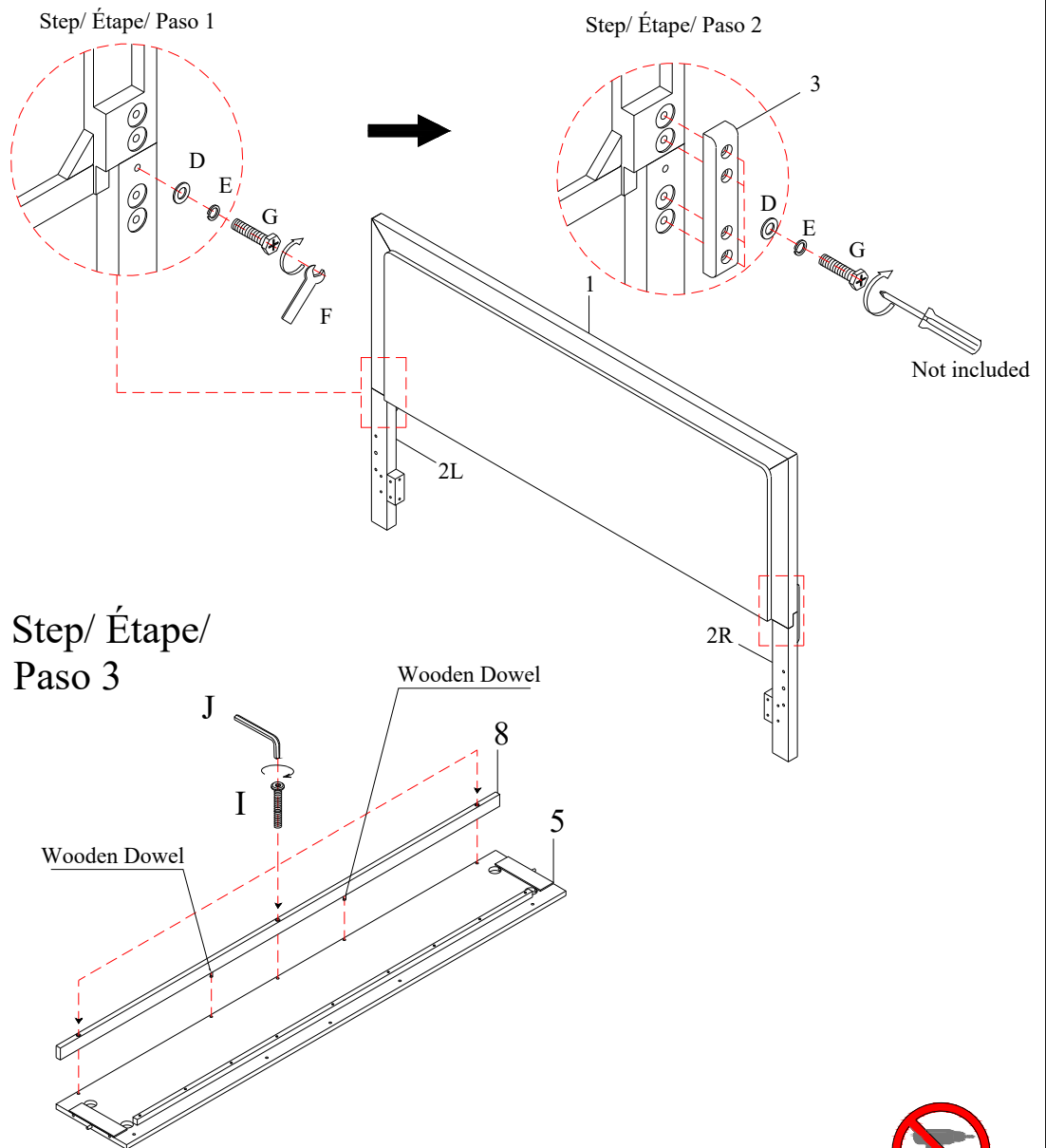

NOTE:
Spirit level not included but necessary to level product on floor.
Niveau à bulle non inclus mais nécessaire pour niveler le produit au sol.
Nivel de burbuja no incluido pero necesario para nivelar el producto en el piso.



WARNING:
ONLY USE THE HAND
TOOLS PROVIDED

ASSEMBLY INSTRUCTIONS INSTRUCTIONS DE MONTAGE INSTRUCCIONES DE MONTAJE

KING PANEL BED HEADBOARD
KING PANEL BED FOOTBOARD
CAL.KING PANEL BED RAILS

Note:

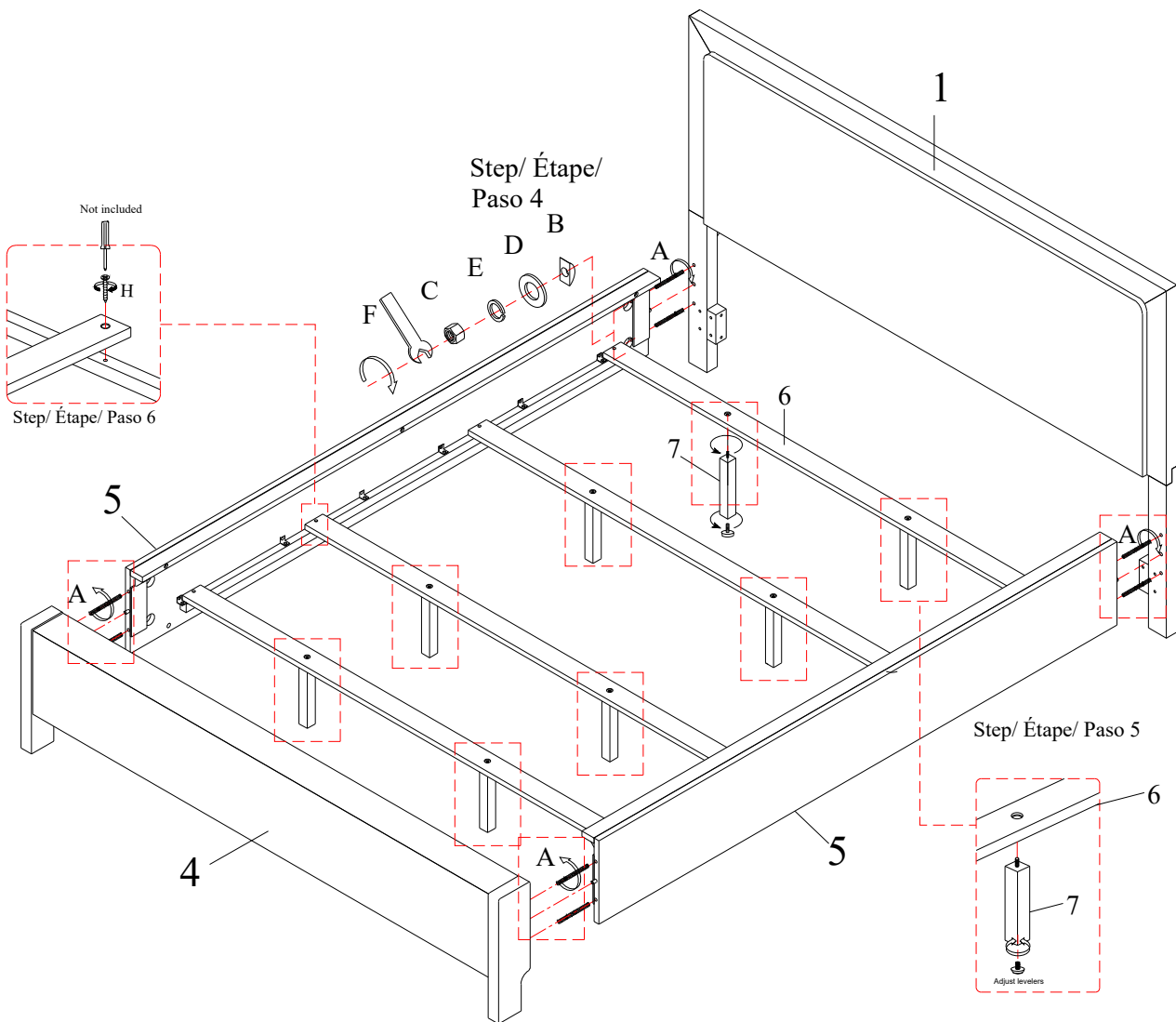
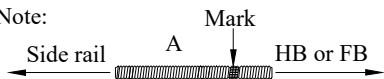

NOTE:

Spirit level not included but necessary to level product on floor.
Niveau à bulle non inclus mais nécessaire pour niveler le produit au sol.
Nivel de burbuja no incluido pero necesario para nivelar el producto en el piso.



WARNING:
ONLY USE THE HAND
TOOLS PROVIDED

ASSEMBLY INSTRUCTIONS INSTRUCTIONS DE MONTAGE INSTRUCCIONES DE MONTAJE

KING PANEL BED HEADBOARD
KING PANEL BED STORAGE FOOTBOARD
CAL.KING PANEL BED RAILS









CAUTION: PLEASE READ ALL INSTRUCTIONS BEFORE STARTING THE ASSEMBLY OF THIS PRODUCT. THESE PIECES ARE HEAVY. IN ORDER TO PREVENT PERSONAL INJURY AND ENSURE THAT THIS PRODUCT IS NOT DAMAGED DURING THE ASSEMBLY PROCESS, IT IS STRONGLY RECOMMENDED TO ENLIST THE ASSISTANCE OF ONE OR MORE PERSONS. IN CASE OF EXCESS STAIN, WIPE THE BOTTOM OF THE UNIT BEFORE PLACING ON ANY SURFACE.

ATTENTION: VEUILLEZ LIRE TOUTES LES INSTRUCTIONS AVANT DE COMMENCER L'ASSEMBLAGE DE CE PRODUIT. LES PIÉCES SONT LOURDES. POUR ÉVITER TOUTE BLESSURE ET POUR VOUS ASSURER QUE LE PRODUIT N'EST PAS ENDOMMAGÉ PENDANT L'ASSEMBLAGE, NOUS VOUS RECOMMANDONS DE FAIRE APPEL À UNE OU PLUSIEURS AUTRES PERSONNES. EN CAS DE TACHE EXCESSIVE, ESSUYEZ LE FOND DE L'UNITÉ AVANT LE PLACEMENT SUR N'IMPORTE QUELLE SURFACE.



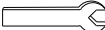

CUIDADO: FAVOR DE LEER TODAS LAS INSTRUCCIONES ANTES DE ENSAMBLAR SU PRODUCTO, ESTAS PIEZAS SON PESADAS. PARA PREVENIR HERIDAS PERSONALES Y ASEGURAR QUE SU PRODUCTO NO SEA DAÑADO MIENTRAS ES ENSAMBLADO. SE RECOMIENDA LA ASISTENCIA DE UNA O MÁS PERSONAS.

WARNING: PROTECTIVE GLIDE IS PLACED UNDER EACH LEG OF THE FURNITURE TO RESIST SCRATCHES ON FLOOR SURFACE. SOME FLOOR SURFACES CAN BE EXTRA SENSITIVE TO SCRATCHES AND MARKINGS, IF YOU ARE NOT SURE CONSULT WITH YOUR DEALER. AVERTISSEMENT. LES PIEDS DES MEUBLES SONT MUNIS DE PATINS DESTINÉS À PROTÉGER LE PLANCHER. CERTAINS REVÊTEMENTS DE SOL PEUVENT ÊTRE TRÈS FRAGILES. EN CAS DE DOUTE. CONSULTER LE MARCHAND.

LIST OF PARTS AND HARDWARE/ LISTE DES PIÈCES ET DU MATÉRIEL/ LISTA DE PIEZAS Y HARDWARE

NO#/ NOMBRE/ NÚMERO	DESCRIPTION/ DESCRIPTION/ DESCRIPCIÓN	QUANTITY/ QUANTITÉ/ CANTIDAD
A	BOLT/ BOULON/ TORNILLO Ø5/16" x 4-1/2"L 	8 PCS
B	HALF MOON WASHER / BOULON DEMI-LUNE / RONDANA DE MEDIA LUNA M8x30x15x8mm 	8 PCS
C	NUT/ ÉCROU/ NUEZ Ø5/16"x12x6mm 	8 PCS
D	FLAT WASHER/ RONDELLE PLATE/ ARANDELA PLANA Ø5/16"x19x2mm 	18 PCS
E	LOCK WASHER/ RONDELLE DE BLOCAGE/ARANDELA DE BLOQUEO Ø5/16"x12x2mm 	18 PCS
F	WRENCH/ CLÉ/ LLAVE INGLESA M12 	1 PC
G	BOLT/ BOULON/ TORNILLO Ø5/16" x 1-1/2"L 	10 PCS
H	SCREW/ VIS/ TORNILLO M4 x 1"L 	29 PCS
I	BOLT/ BOULON/ TORNILLO Ø1/4" x 1-3/4"L 	6 PCS
J	ALLEN KEY/ CLÉ ALLEN/ LLAVE INGLESA ALLEN M4 	1 PC

LIST OF PARTS AND HARDWARE/ LISTE DES PIÈCES ET DU MATÉRIEL/ LISTA DE PIEZAS Y HARDWARE

NO#/ NOMBRE/ NÚMERO	DESCRIPTION/ DESCRIPTION/ DESCRIPCIÓN	QUANTITY/ QUANTITÉ/ CANTIDAD
1	HEADBOARD PANEL/ PANNEAU DE TÊTE DE LIT/ PANEL DE CABECERO 	1 PC
2L	LEFT HEADBOARD LEG/ PIED DE TÊTE DE LIT GAUCHE/ PIERNA IZQUIERDA DE LA CABECERA 	1 PC
2R	RIGHT HEADBOARD LEG/ PIED DE TÊTE DE LIT DROIT/ PATA DERECHA DE LA CABECERA 	1 PC
3	MENDING PLATE/ PLAQUE DE RÉPARATION/ PLATO DE REPARACIÓN 	2 PCS
4	STORAGE FOOTBOARD / MARCHEPIED DE RANGEMENT/ PIE DE CAMA DE ALMACENAMIENTO 	1 PC

NOTE:
ASSEMBLE UNIT ON A SOFT SURFACE.
ASSEMBLEZ L'UNITÉ SUR UNE SURFACE MOLLE.
ENSAMBLE LA UNIDAD EN UNA SUPERFICIE PLANA Y SUAVE.





DO NOT TIGHTEN BOLTS UNTIL ALL PARTS AND HARDWARE OF THE UNIT ARE ASSEMBLED.
NE SERREZ PAS LES BOULONS JUSQU'À CE QUE L'UNITÉ SOIT COMPLÈTEMENT ASSEMBLÉE.
NO APRIETE LOS TORNILLOS HASTA QUE LA UNIDAD ESTE COMPLETAMENTE ENSAMBLADA.



WARNING:
ONLY USE THE HAND TOOLS PROVIDED

ASSEMBLY INSTRUCTIONS INSTRUCTIONS DE MONTAGE

KING PANEL BED HEADBOARD KING PANEL BED STORAGE FOOTBOARD CAL.KING PANEL BED RAILS

5	CAL.KING SIDE RAIL/ RAIL LATÉRAL/ CARRIL LATERAL			2 PCS
6	SLAT SUPPORT/ SUPPORT DE LATTES/ SOPORTE DE LÁMINAS	1970x88x18mm		3 PCS
7	LEG SUPPORT SLAT / JAMBE D'APPUI/ PIERNA DE APOYO	369x34x34mm		9 PCS
8	SLAT ROLL/ROULEAU DE LATTES/ ROLLO DE LAMAS	Included 13pcs (1952mm)		1 SET
9	SITE RAIL CLEAT / TAQUET DE RAIL DE SITE/ LIMPIEZA DEL RIEL DEL SITIO			2 PCS

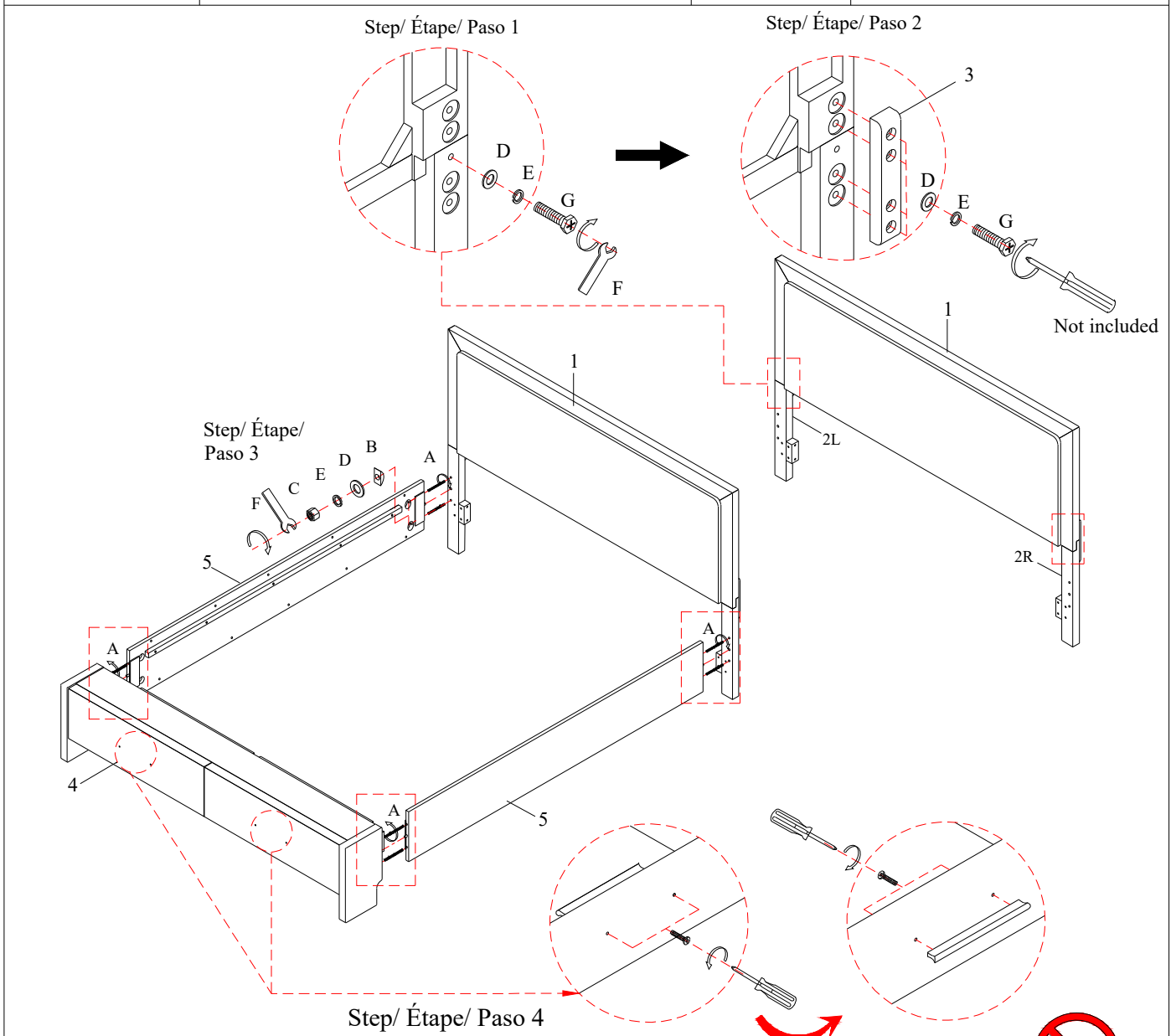

Not included

NOTE:
 Spirit level not included but necessary to level product on floor.
 Niveau à bulle non inclus mais nécessaire pour niveler le produit au sol.
 Nivel de burbuja no incluido pero necesario para nivelar el producto en el piso.



WARNING:
ONLY USE THE HAND
TOOLS PROVIDED

ASSEMBLY INSTRUCTIONS INSTRUCTIONS DE MONTAGE INSTRUCCIONES DE MONTAJE

KING PANEL BED HEADBOARD
KING PANEL BED STORAGE FOOTBOARD
CAL.KING PANEL BED RAILS

Note:

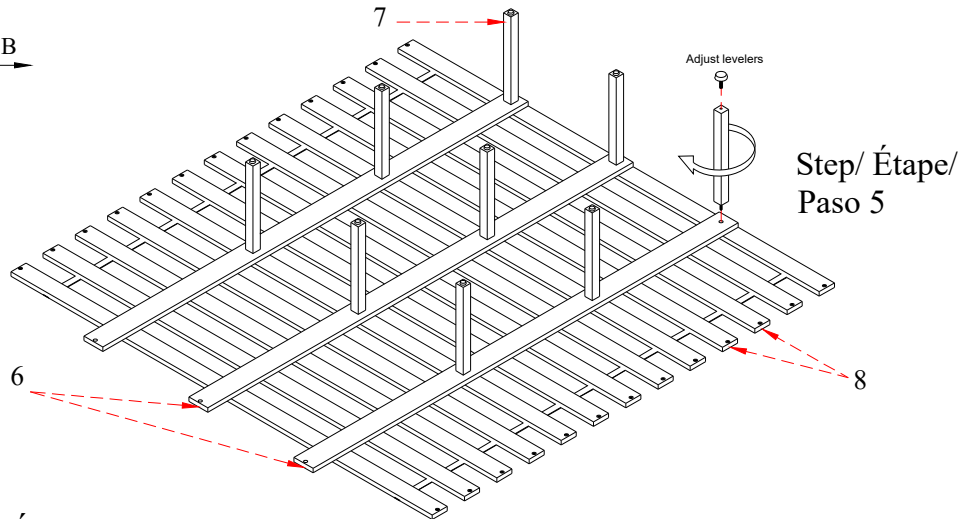
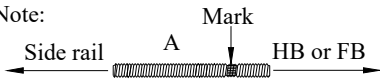

Step/ Étape/ Paso 7 Wooden Dowel

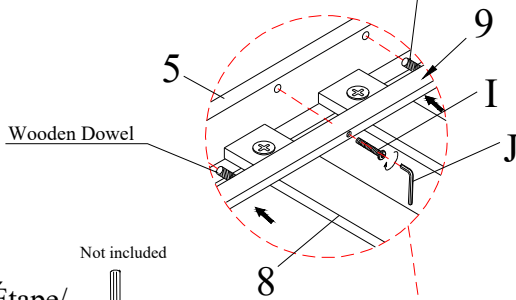

Step/ Étape/ Paso 6

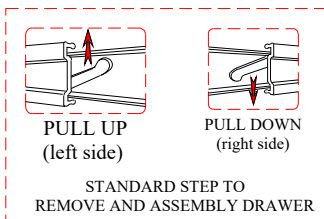
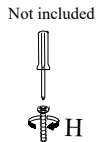

NOTE:

Spirit level not included but necessary to level product on floor.

Niveau à bulle non inclus mais nécessaire pour niveler le produit au sol.

Nivel de burbuja no incluido pero necesario para nivelar el producto en el piso.



WARNING:
ONLY USE THE HAND
TOOLS PROVIDED