

SWING WICKER EGG CHAIR

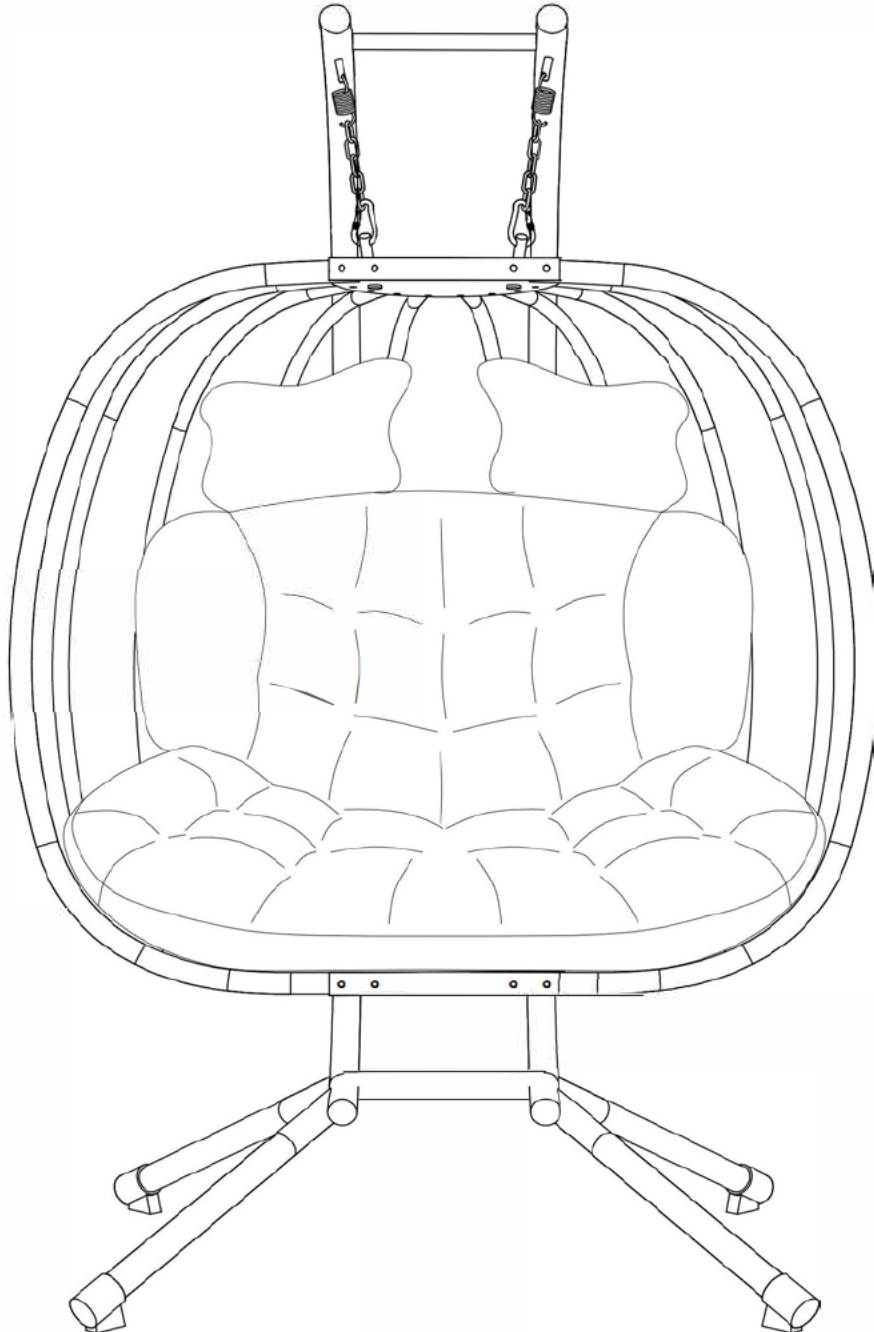

INSTRUCTION MANUAL
MAXIMUM WEIGHT CAN HOLD UP TO 700LBS

IMPORTANT SAFETY INSTRUCTIONS

- Semi-tighten each bolts during assembly.
- Ensure all bolts are tightened when fully assembled.
- Always place the product on a flat, steady and stable surface.

TIPS BEFORE YOU START

Thanks for choosing us.

- Please check that all parts are present before you start the assembly of your furniture.
- You commence each step of the assembly, that you identify all the parts required for that step.
- For larger items, please ensure that you have sufficient space and people(suggest two people) to assemble your product safely.
- We recommend that, where possible, all items are assembled near to the area in which they will be placed in use, to avoid moving the product unnecessarily once assembled.
- For the protection of your furniture, we recommend that the product is placed on a protected surface during assembly to prevent any damage.
- During assembly please take care not to over-tighten any fittings, as this may damage the product. Do not use power tools.
- Always place the product on a flat, steady and stable surface.
- Do not stand on the product. Do not use the product as a stepladder.
- This product is intended household use only as it is a non-industrial product.
- Please use caution and care when lifting the product to avoid personal injury and/or product damage.













CARE AND MAINTAINANCE



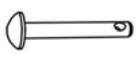



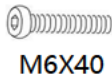

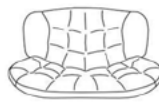

- When left exposed to the elements for a period of time, steel may rust and fabric may fade.
- To prolong the life of your furniture, clean and dry frame regularly.
- Use car polish or similar product for extra protection of metal components. Use spray lubricant or similar on nuts and bolts.
- We recommend storing furniture under cover, out of direct sunlight and using furniture covers when not in use and for protection during the winter months.
- To clean cushions, sponge surface clean with mild soapy water. Allow to air dry in the shade. To avoid stains, remove spills promptly. Do not use solvent type cleaners. Do not machine wash, dry clean or tumble dry. Never store cushions when wet. We recommend that all cushions are stored inside to extend their life.

WICKER CARE

- To clean wicker, wash down regularly with mild soapy water and rinse with fresh water. Hose regularly with fresh water to remove airborne contaminants.
- Our wicker style furniture & cushions contain UV treatment to help protect them against deterioration, some fading will occur over time. When it is cold, the weave may become stiffer than normal. When hot, the weave will become more elastic. Wicker style furniture will revert to its normal elasticity, once the temperature stabilises.

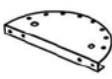
PART NAME

A		1
B		4
C		1
D		2
E		1
F		4
G		4
H		4
I		2
J		2
K		2
L	 M6X40	8
M		24

N		2
O		4
P		1
Q		1
R		2
S		1
T		1
U		2
V		2
W		1
X	 M6X22	16
Y		24

INSTALLATION STEPS

Step1

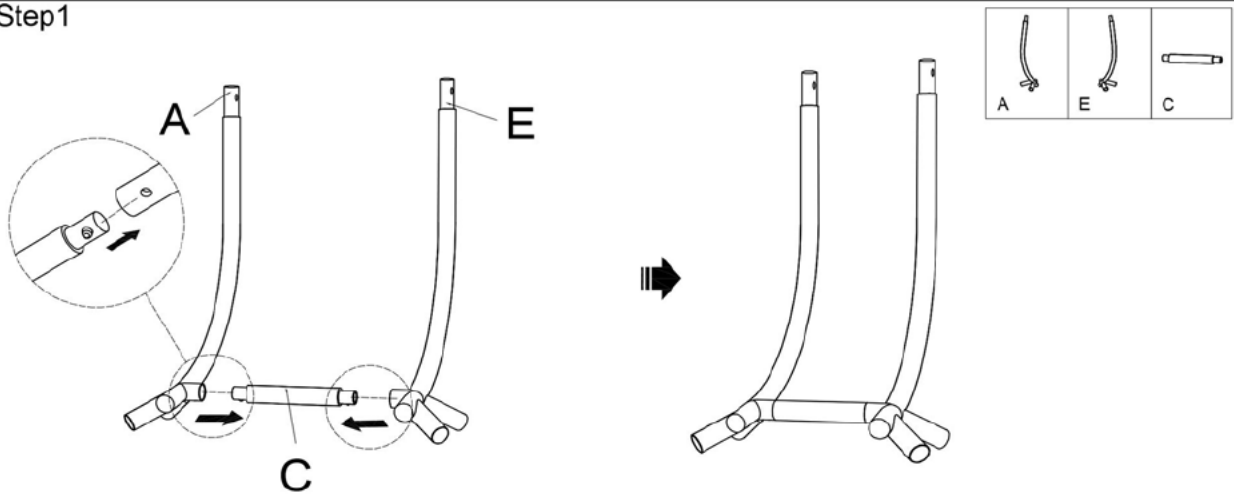

Step2

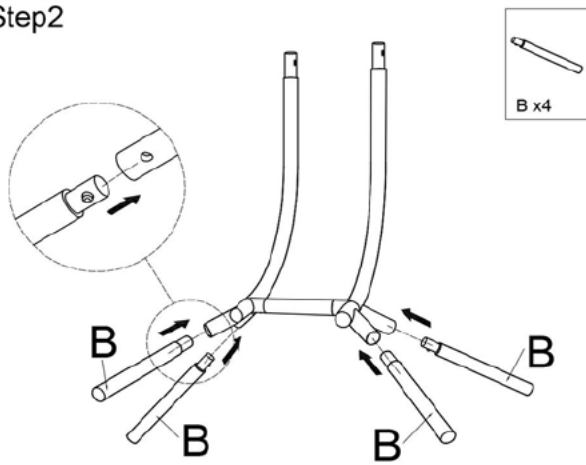

Step3

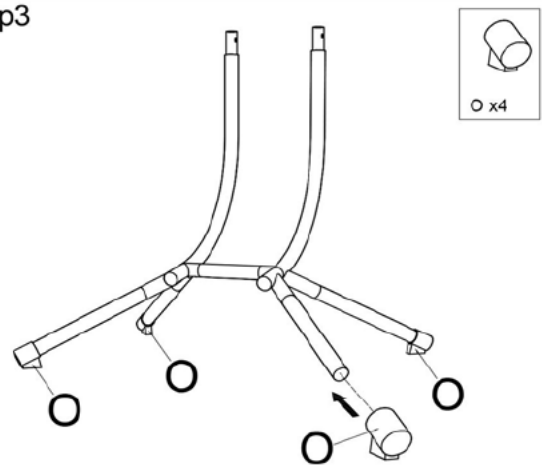

Step4

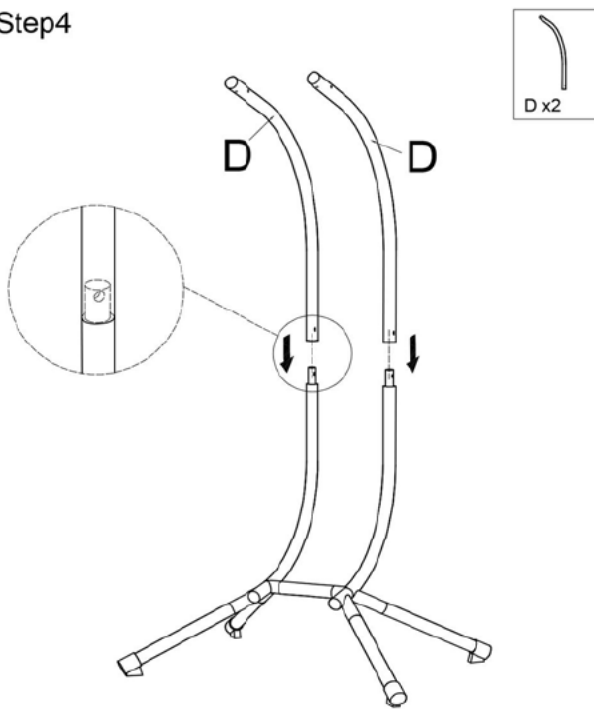

Step5

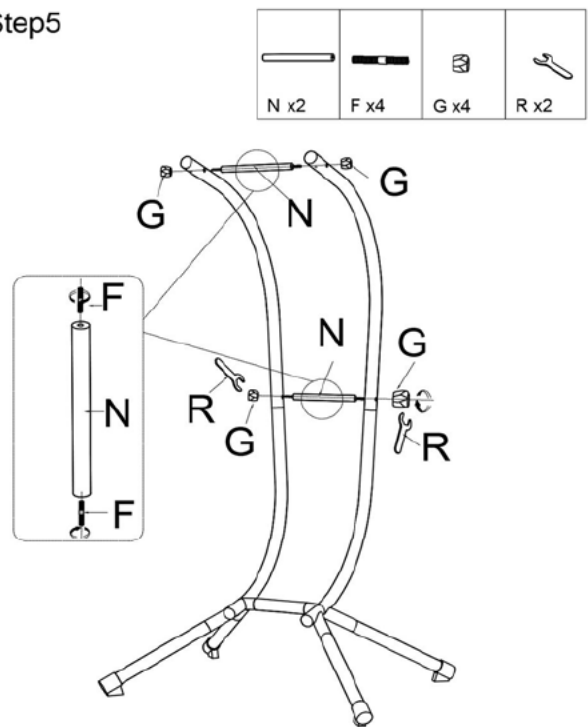

INSTALLATION STEPS

Step6

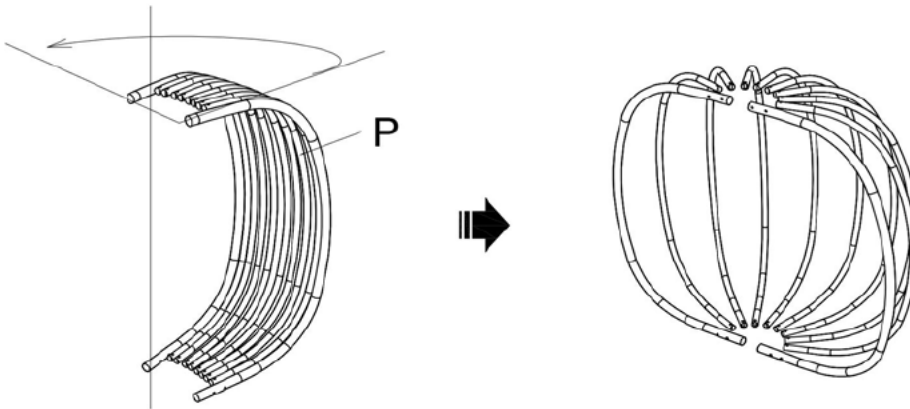

Step7

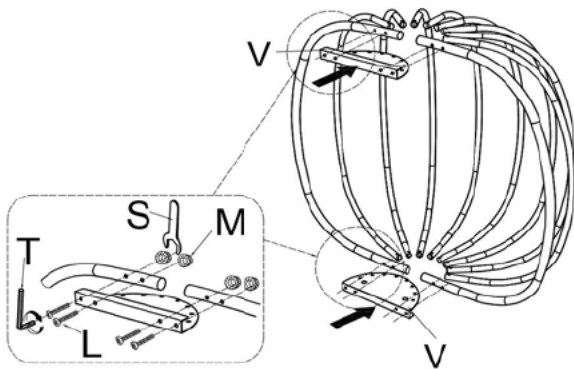
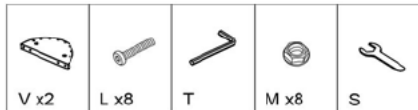

Step8

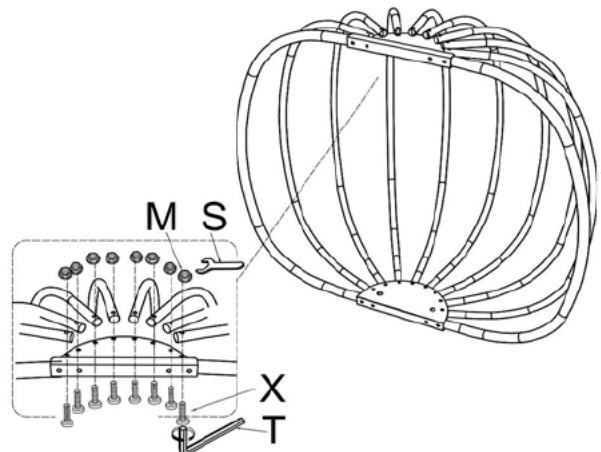
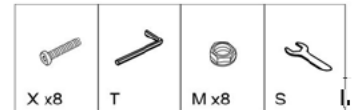

Step9

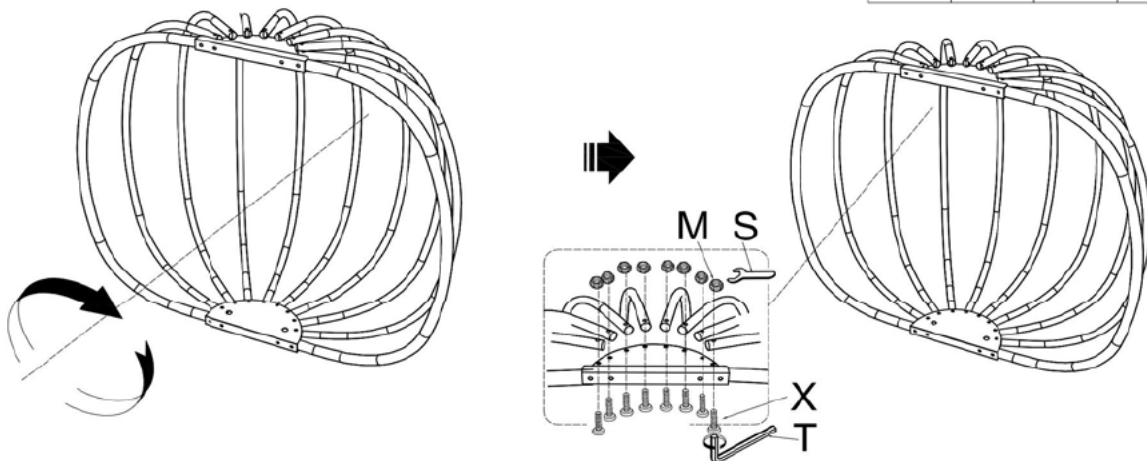
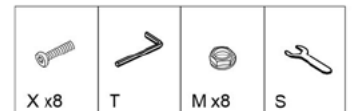

INSTALLATION STEPS

Step10

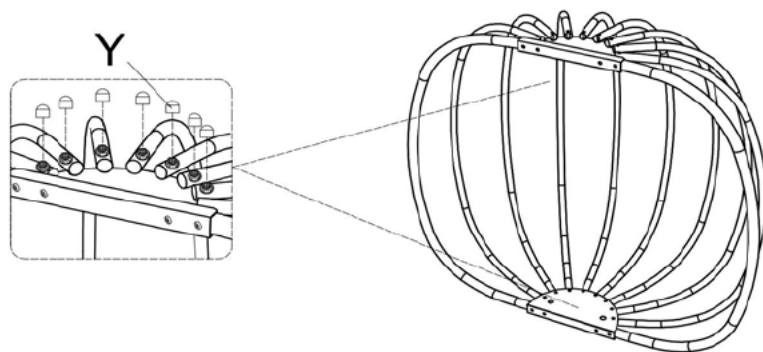

Step11

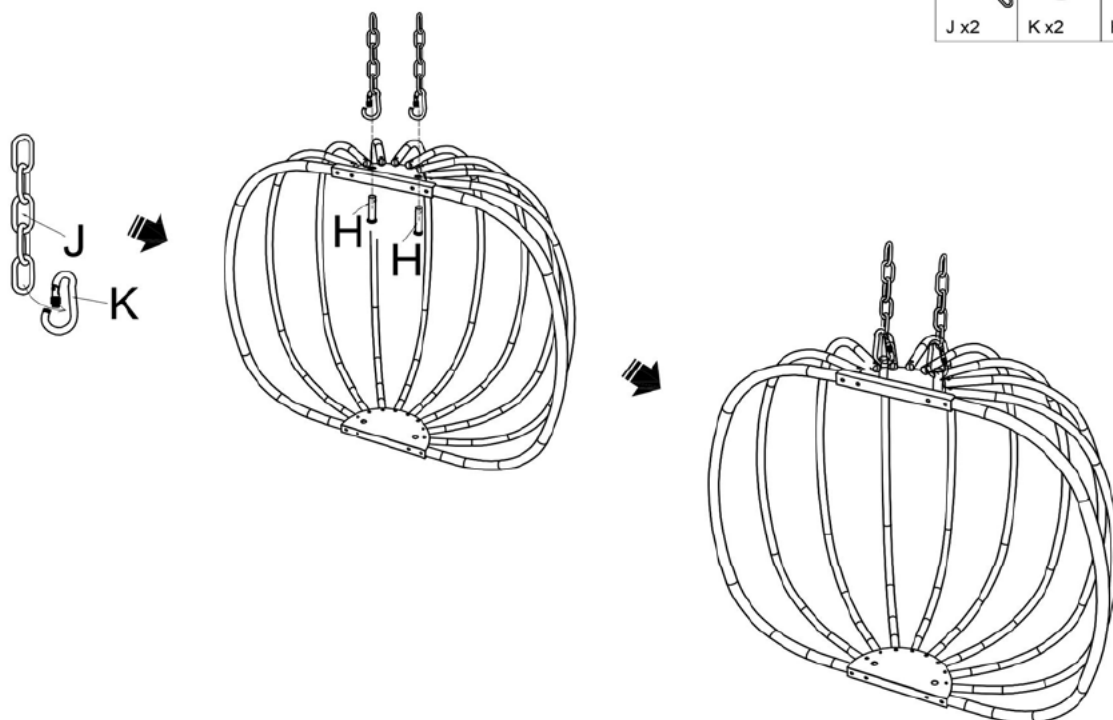
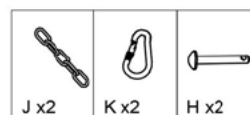

INSTALLATION STEPS

Step12

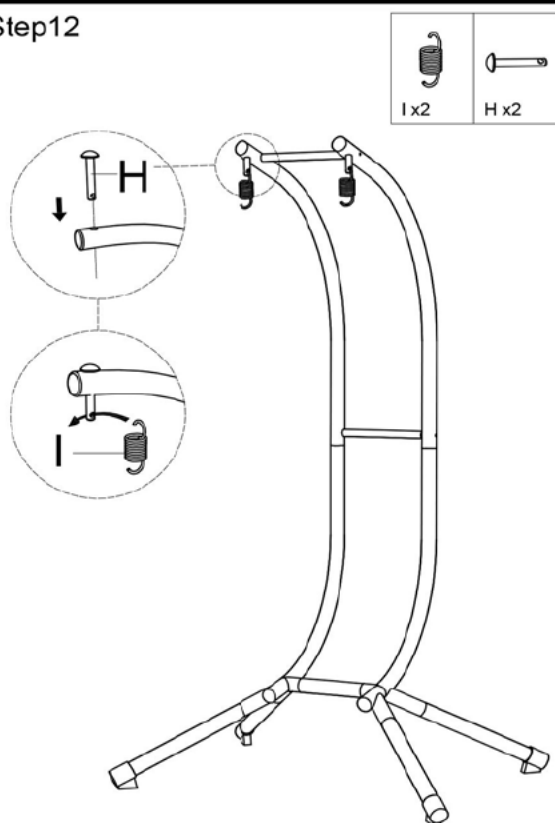

Step13

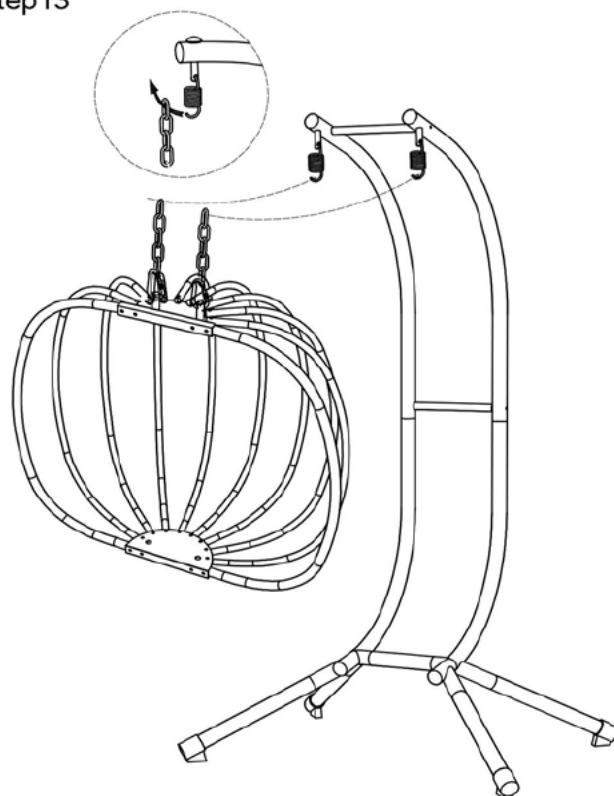

Step14

