

Thank you for your purchase!

## ASSEMBLY INSTRUCTIONS

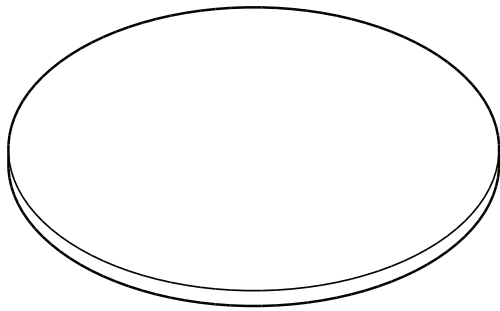

# 30x30 Commercial Tabletop

**Before You Begin:** A power drill is required to attach tabletop to a compatible base (Base not included).

Please identify all component parts and hardware pieces required before you begin. Carefully remove all of the components from the packaging and set aside for assembly. Assemble on a soft surface to prevent scratching during assembly.

**Caution:**

Tighten all components securely before use. Failure to do so may result in personal injury. DO NOT use any sharp objects to open plastic wrapped components as damage to product or components may result.

**Warning:**

**CHOKING HAZARD - Small Parts Adult Assembly Required**

Injury may result from tipping furniture. You must install the Tipping Restraint Hardware with the unit to prevent the unit from tipping and causing any accidental injury, instability, death, or damage. The tipping restraint is intended only as a safety measure. It is not a substitute for proper adult supervision.

This tipping restraint is not an earthquake restraint. If you wish to add the extra security of earthquake restraints, they must be purchased and installed separately.

Serious or fatal crushing injuries can occur from furniture tipping over. To prevent furniture from tipping over, it must be permanently fixed to the wall. Fixing devices for the wall are not included since different wall materials require different types of fixing devices. Use fixing devices suitable for the walls in your home.

Failure to detach this restraint before moving furniture may result in injury or damage.

**DO NOT ALLOW CHILDREN TO CLIMB ON FURNITURE**



We pride ourselves on providing an excellent customer experience starting right here with your package and instructions. Everything you need should be right where you need it, so you can get to enjoying your new item ASAP. But despite our best efforts, sometimes "slips happen." If you need any support, from replacement parts to recommendations, please reach out to our wonderful customer support team. We're here to help!

## EVERY UBIQUE GROUP PRODUCT



Quality &  
Durability Tested



Packaged  
with Care



Shipped from  
our U.S. Facility

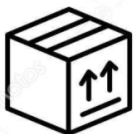

Designed  
for Easy  
Assembly



Ethically  
Sourced

**Read this manual before using this product. Failure to follow the instructions and safety precautions in this manual can result in serious injury or death. Keep this manual in a safe location for future reference.**

**PART**

**QTY : 1 PC**

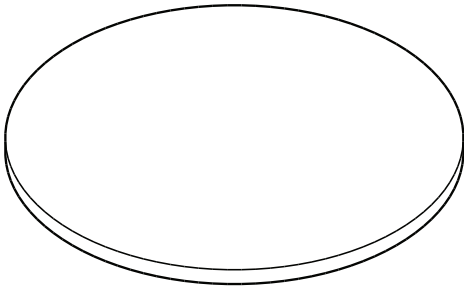

**PART 1 : TABLE TOP**

**HARDWARE**

**QTY : 8 PC**

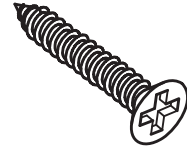

**PART A : SELF-TAPPING SCREW  
M4 x 24 MM**

**ASSEMBLY**

Base is for illustrative purposes only, not included.

**STEP 1 :**

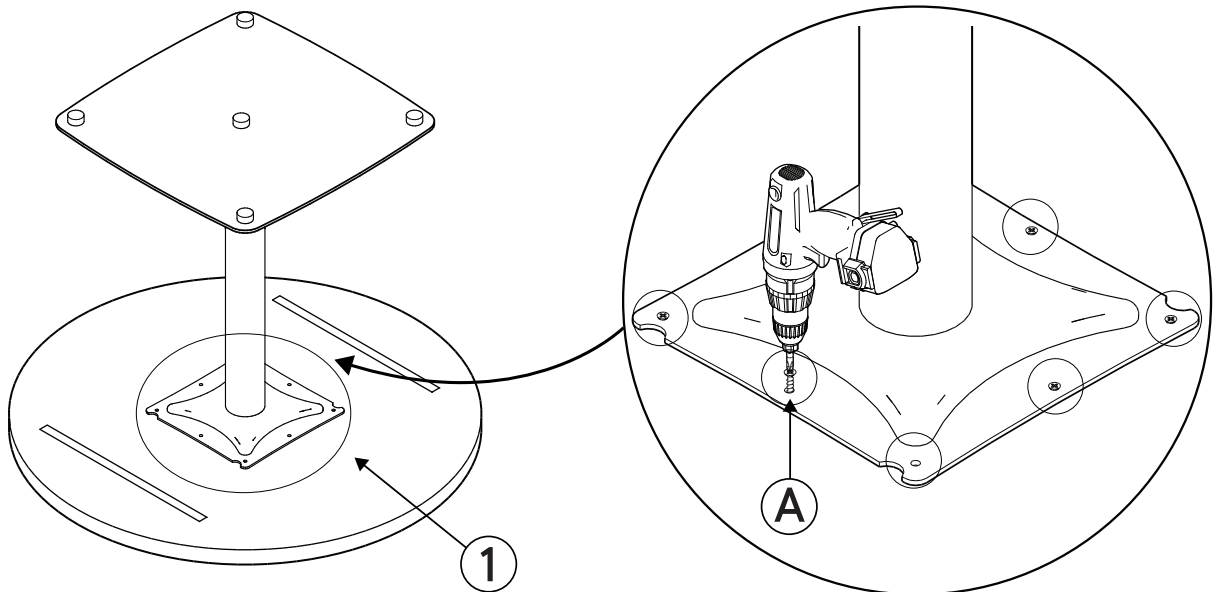

**FINISH :**

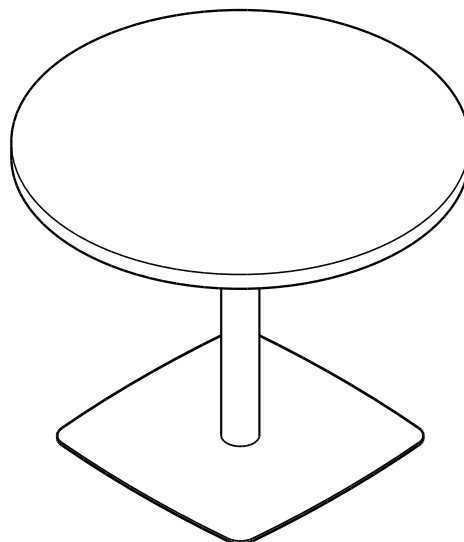

## Quality and Safety Guidelines:

- Please follow the static and dynamic weight capacity limits provided on this item. If you are unsure of the weight capacities for this product, contact us.
- Please use this item on a stable, level surface only. All table/base legs should contact the flooring surface when in use. Do not use this item if any instability is detected.
- For maintenance instructions and replacement parts, please contact us.
- This item is intended as a table only, do not climb, stand or sit on this item. Do not use as a TV stand.
- Do not slide this item when moving it.
- The item is intended to be used indoors.
- For product longevity, product safety and product integrity, protect from wet and humid weather or other wet, humid or moist conditions and store indoors in a dry location. For additional storage and usage instructions, please contact us.

Thank you for your purchase!

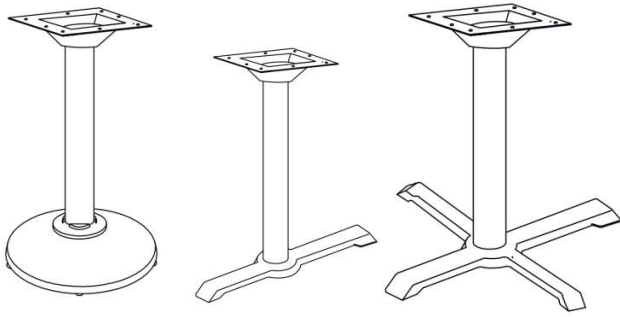

**Restaurant Table X-Base, T-Base, or Round-Base with 3" or 4" Diameters and Table Height or Bar Height Columns**

## ASSEMBLY INSTRUCTIONS

### **Before You Begin:**

Please identify all component parts and hardware pieces required before you begin. Carefully remove all of the components from the packaging and set aside for assembly. Assemble on a soft surface to prevent scratching during assembly.

### **Caution:**

Tighten all components securely before use. Failure to do so may result in personal injury. DO NOT use any sharp objects to open plastic wrapped components as damage to product or components may result.

### **Warning:**

CHOKING HAZARD - Small Parts. Adult Assembly Required.

Injury may result from tipping furniture. You must install the Tipping Restraint Hardware with the unit to prevent the unit from tipping and causing any accidental injury, instability, death or damage. The tipping restraint is intended only as a safety measure, it is not a substitute for proper adult supervision.

This tipping restraint is not an earthquake restraint. If you wish to add the extra security of earthquake restraints, they must be purchased and installed separately.

Serious or fatal crushing injuries can occur from furniture tipping over. To prevent furniture from tipping over it must be permanently fixed to the wall. Fixing devices for the wall are not included since different wall materials require different types of fixing devices. Use fixing devices suitable for the walls in your home.

Failure to detach this restraint before moving furniture may result in injury or damage.

DO NOT ALLOW CHILDREN TO CLIMB ON FURNITURE



We pride ourselves on providing an excellent customer experience starting right here with your package and instructions. Everything you need should be right where you need it, so you can get to enjoying your new item ASAP. But despite our best efforts, sometimes "slips happen." If you need any support, from replacement parts to recommendations, please reach out to our wonderful customer support team. We're here to help!

## EVERY UBIQUE GROUP PRODUCT



Quality &  
Durability Tested



Packaged  
with Care



Shipped from  
our U.S. Facility

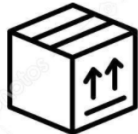





Designed  
for Easy  
Assembly

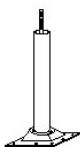
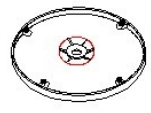
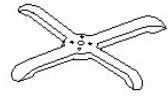
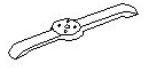

Ethically  
Sourced

**Read this manual before using this product. Failure to follow the instructions and safety precautions in this manual can result in serious injury or death. Keep this manual in a safe location for future reference.**

# PARTS

| Part List |   |   |   |   |   |   |   |   |   |   |   |   |   |
|-----------|---|---|---|---|---|---|---|---|---|---|---|---|---|
| A         |  | B |  | B |  | B |  | C |  | D |  | E |  |
|           | Column<br>1PC<br>2PCS for T base  |   | Round Floor Base<br>1PC   |   | Cross Floor Base<br>1PC   |   | T Floor Base<br>2PCS  |   | Flat Washer Q12<br>1PC<br>2PCS for T base   |   | Nut M12<br>1PC<br>2PCS for T base   |   | Bolt M5*25<br>8PCS<br>16PCS for T base  |

Option 1

Option 2

Option 3

# STEP 1

STEP 1

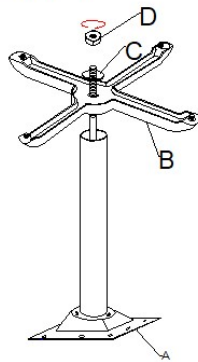

STEP 2

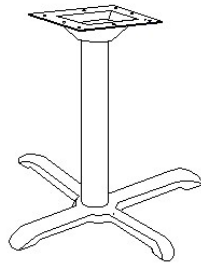

STEP 3

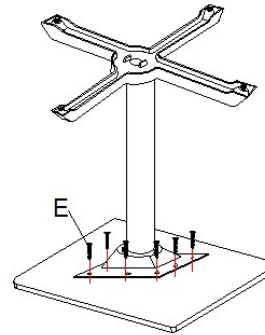

Note: "X" shape and round bases should be centered in the middle of the underside of the table top while the two T-bases should be attached on the left and right undersides of the table top.

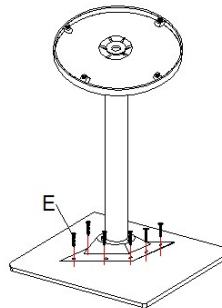
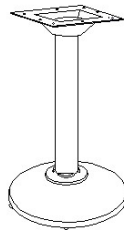
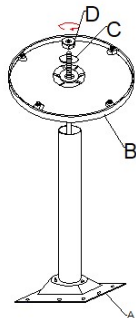

Note: Table top for illustration purposes only, not included

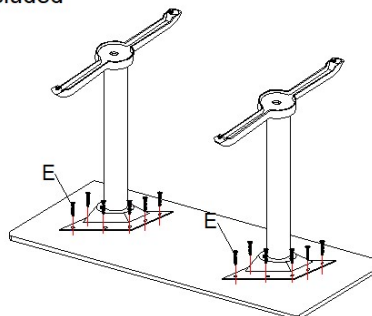
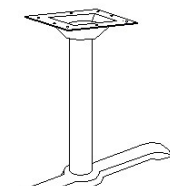
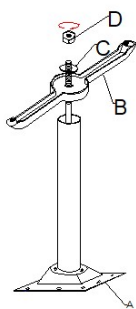

.....

*Thank you for your purchase!*

## Quality and Safety Guidelines:

- Please follow the static and dynamic weight capacity limits provided on this item. If you are unsure of the weight capacities for this product.
- Please use this item on a stable, level surface only. All Parts of the base should contact the flooring surface when in use. Do not use this item if any instability is detected.
- For maintenance instructions and replacement parts, please contact us.
- This item is intended for use with a table only, do not climb, stand or sit on this item.
- For product longevity, product safety and product integrity, protect from extended periods of wet weather and store indoors in a dry location.
- For additional storage instructions, please contact us.

