

cabinet

XY0364

ASSEMBLY INSTRUCTION

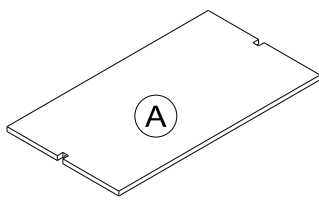
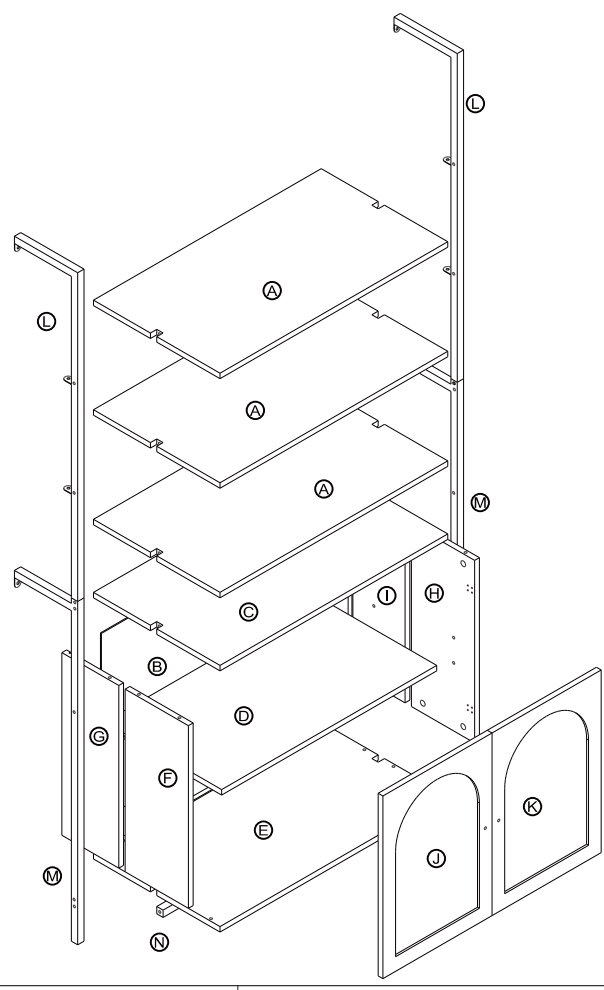

Qty: 3

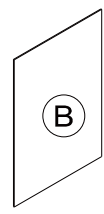

Qty: 1

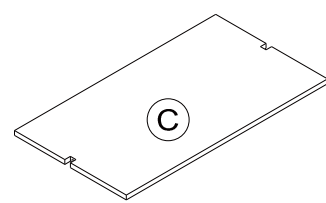

Qty: 1

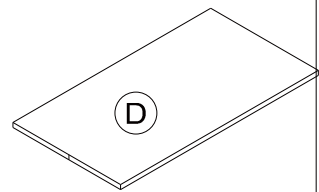

Qty: 1

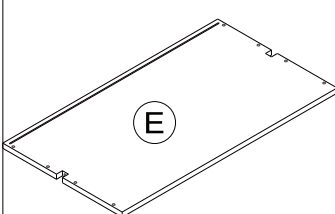

Qty: 1

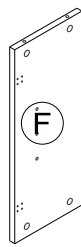

Qty: 1

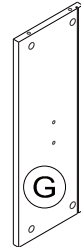

Qty: 1

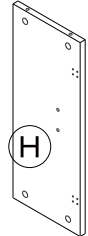

Qty: 1

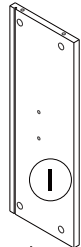

Qty: 1

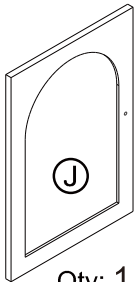

Qty: 1

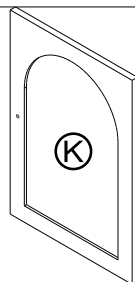

Qty: 1



Qty: 2



Qty: 2

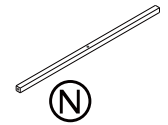

Qty: 1

ASSEMBLY INSTRUCTION



Ø15X9.5mm

| | |
|---|-----|
| ① | X16 |
|---|-----|

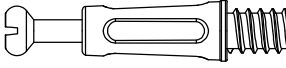

Ø6.5X35mm

| | |
|---|-----|
| ② | X16 |
|---|-----|

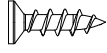

Ø3X15mm

| | |
|---|----|
| ③ | X8 |
|---|----|

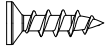

Ø4X12mm

| | |
|---|-----|
| ④ | X24 |
|---|-----|

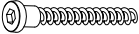

Ø6.3 X40mm

| | |
|---|-----|
| ⑤ | X10 |
|---|-----|

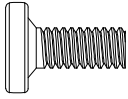

M6X12mm

| | |
|---|----|
| ⑥ | X8 |
|---|----|

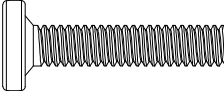

M6X30mm

| | |
|---|----|
| ⑦ | X3 |
|---|----|

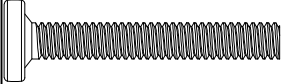

M6X35mm

| | |
|---|----|
| ⑧ | X2 |
|---|----|

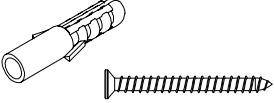

Ø4 X40mm

| | |
|---|----|
| ⑨ | X4 |
|---|----|



⑩ X2 |

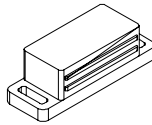

⑪ X2 |

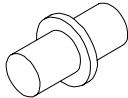

⑫ X4 |

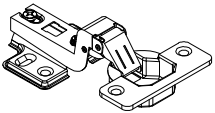

⑬ X4 |

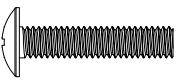

M4X20mm

| | |
|---|----|
| ⑭ | X2 |
|---|----|

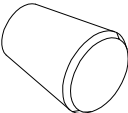

Ø20X24mm

| | |
|---|----|
| ⑮ | X2 |
|---|----|

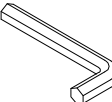

⑯ X1 |

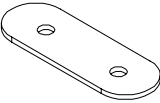

⑰ X2 |

ASSEMBLY INSTRUCTION

STEP 1

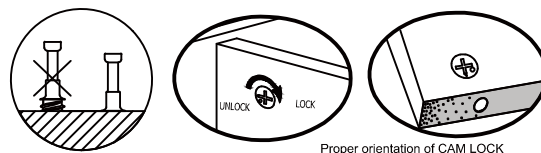
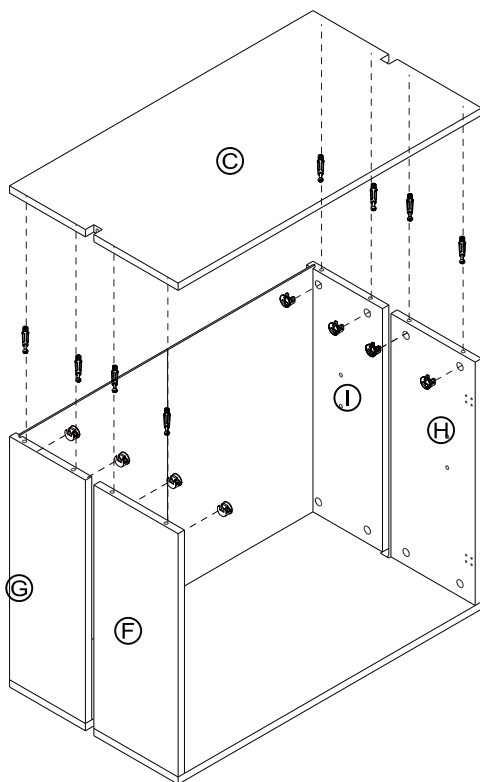
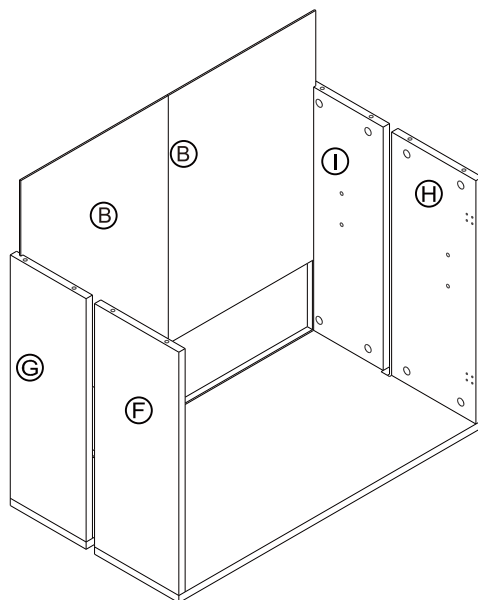
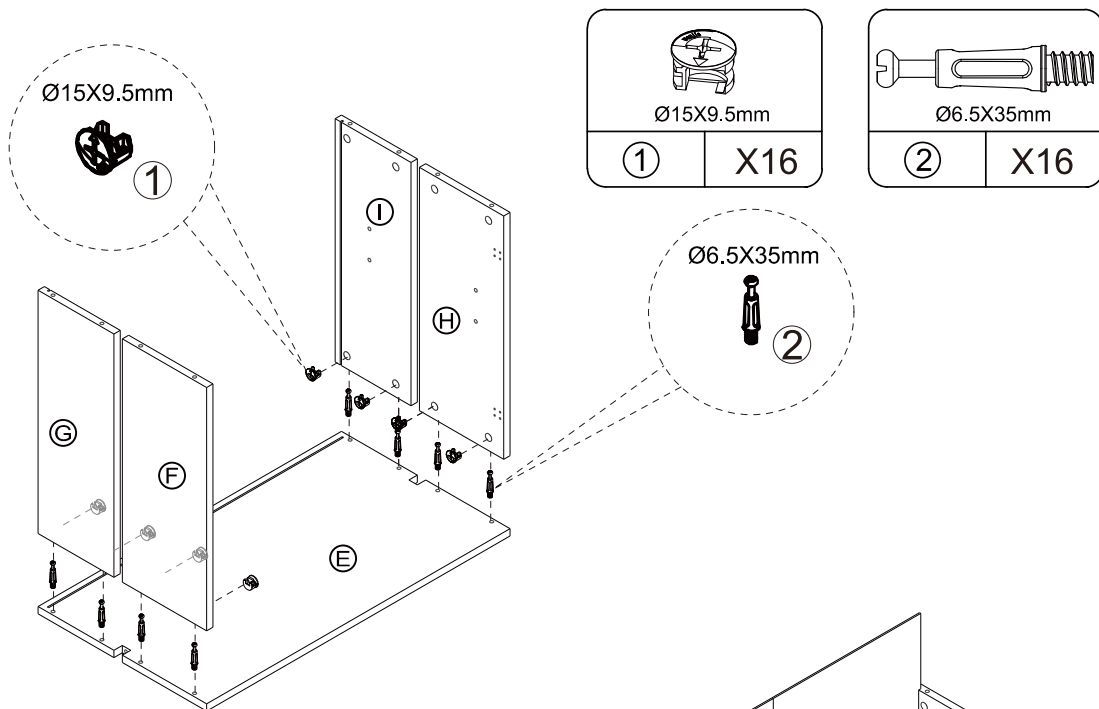

ASSEMBLY INSTRUCTION

STEP2

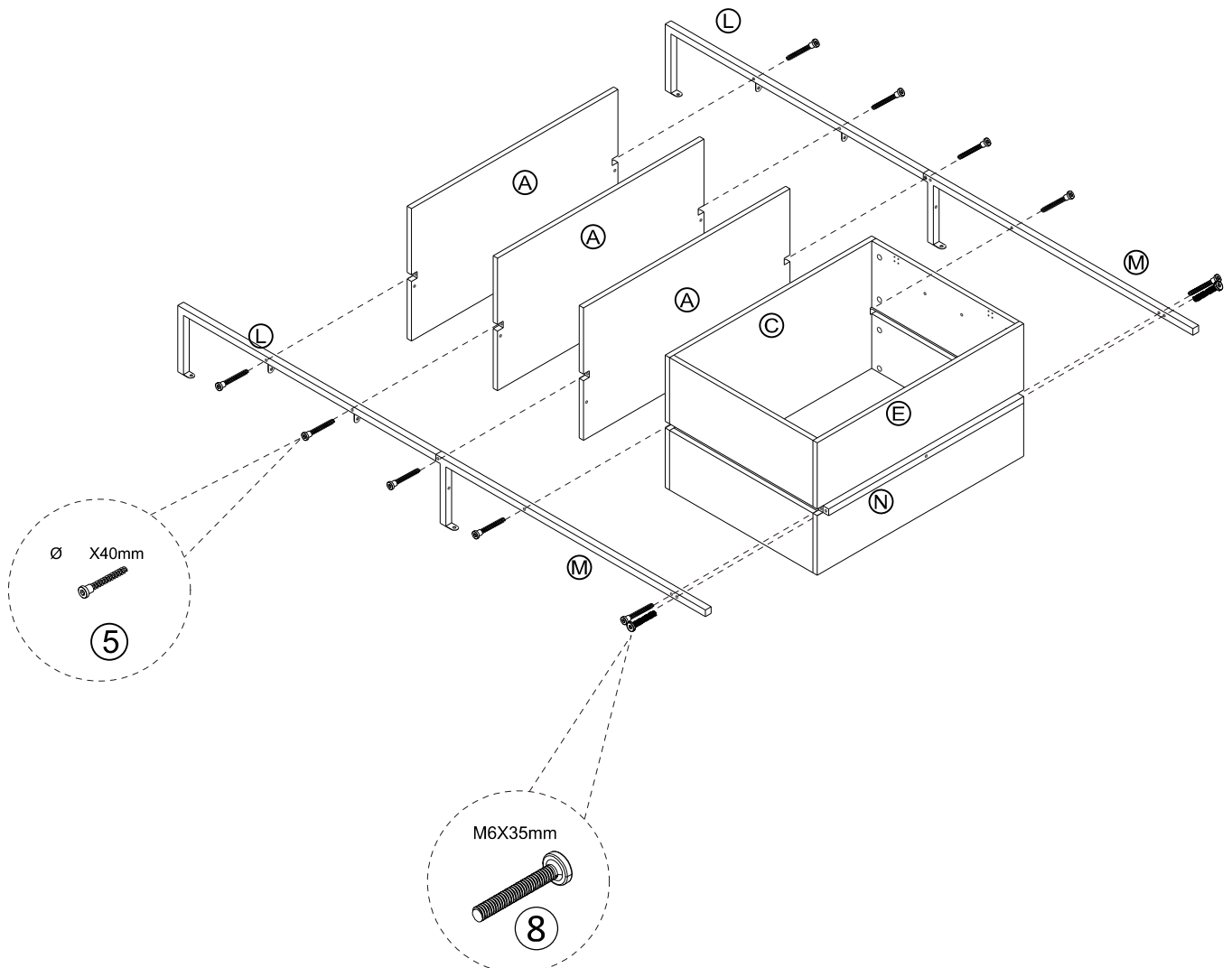
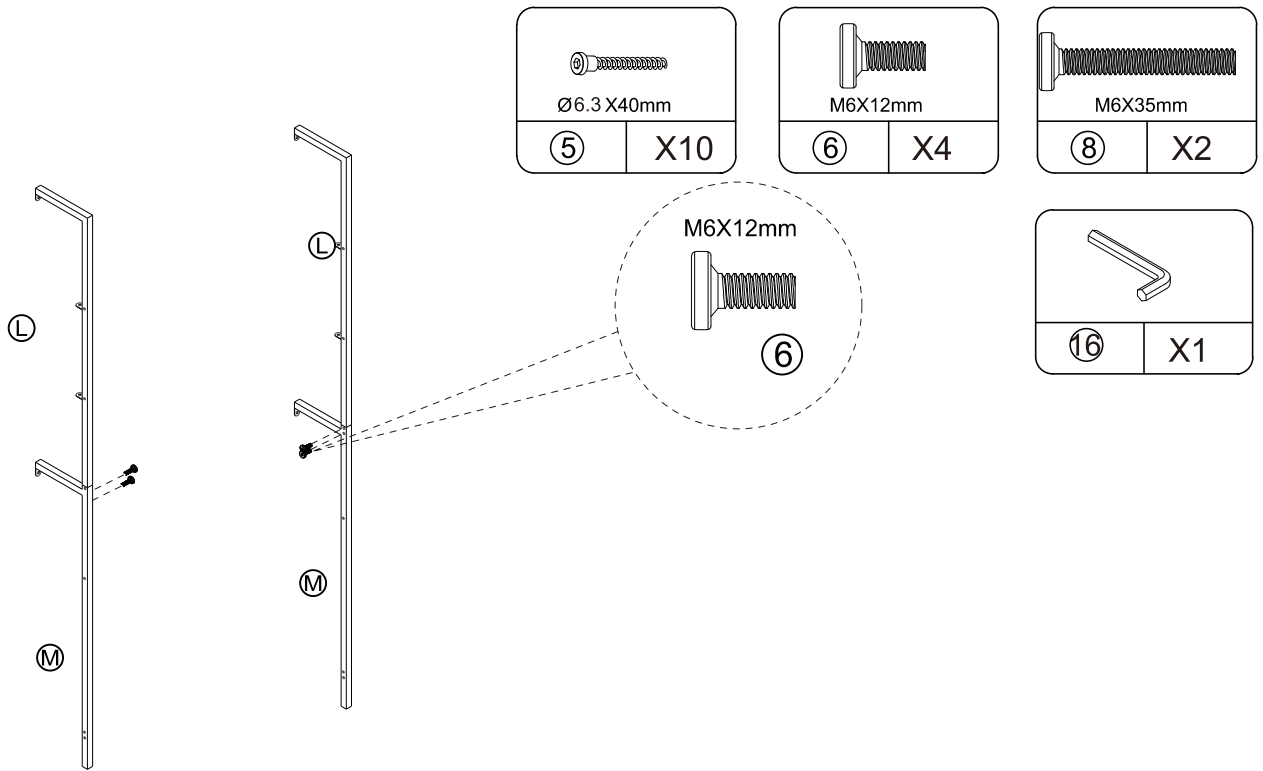

ASSEMBLY INSTRUCTION

STEP3

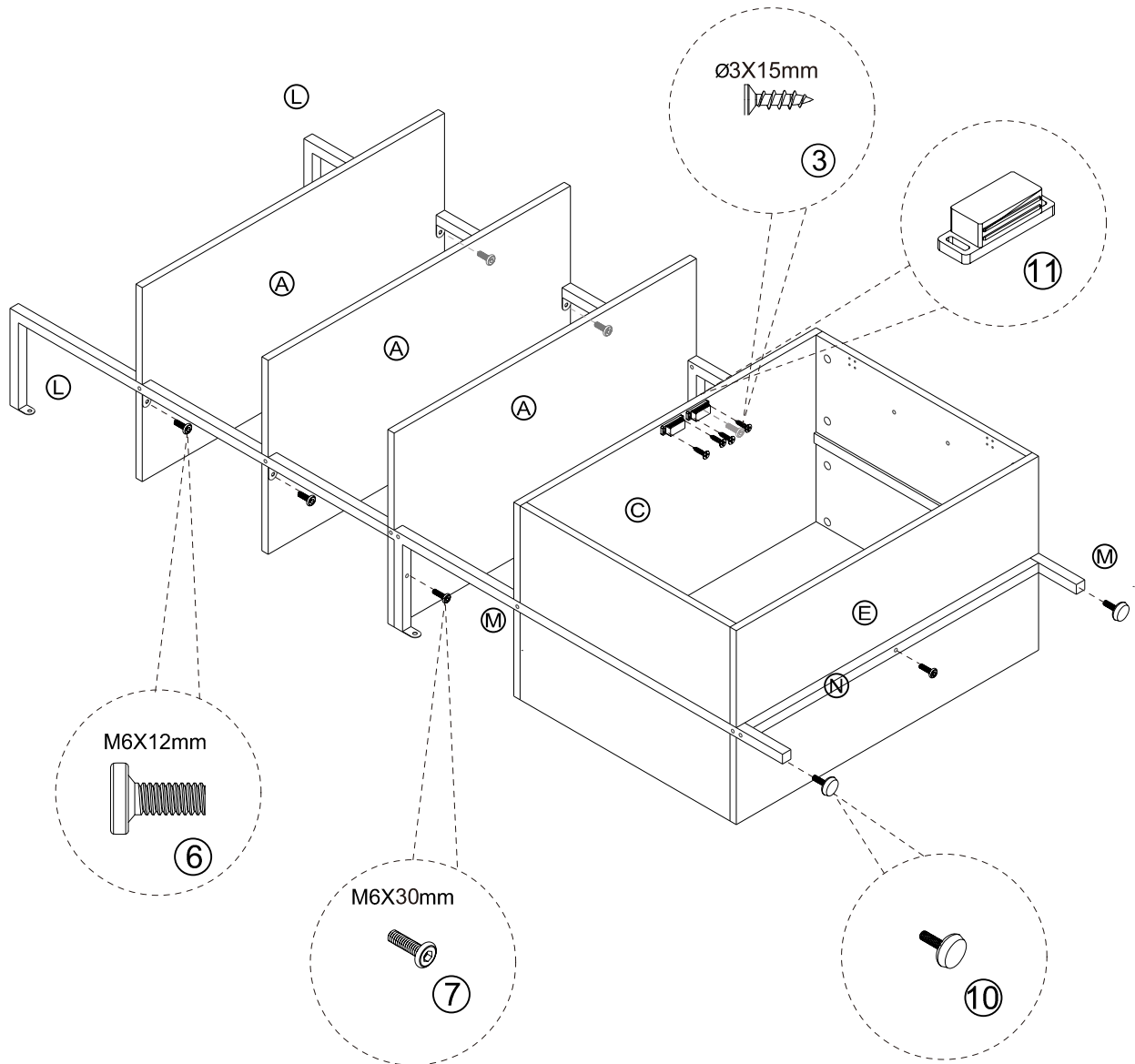
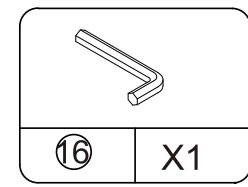
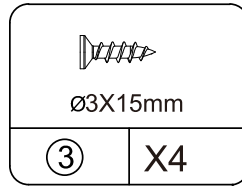
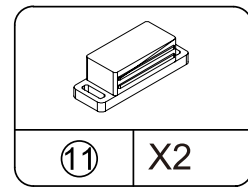
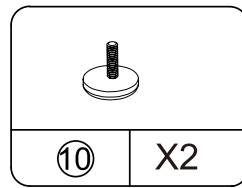
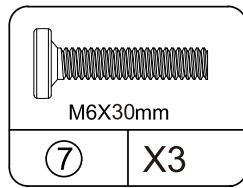
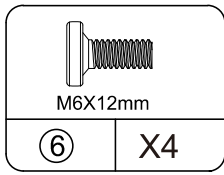

ASSEMBLY INSTRUCTION



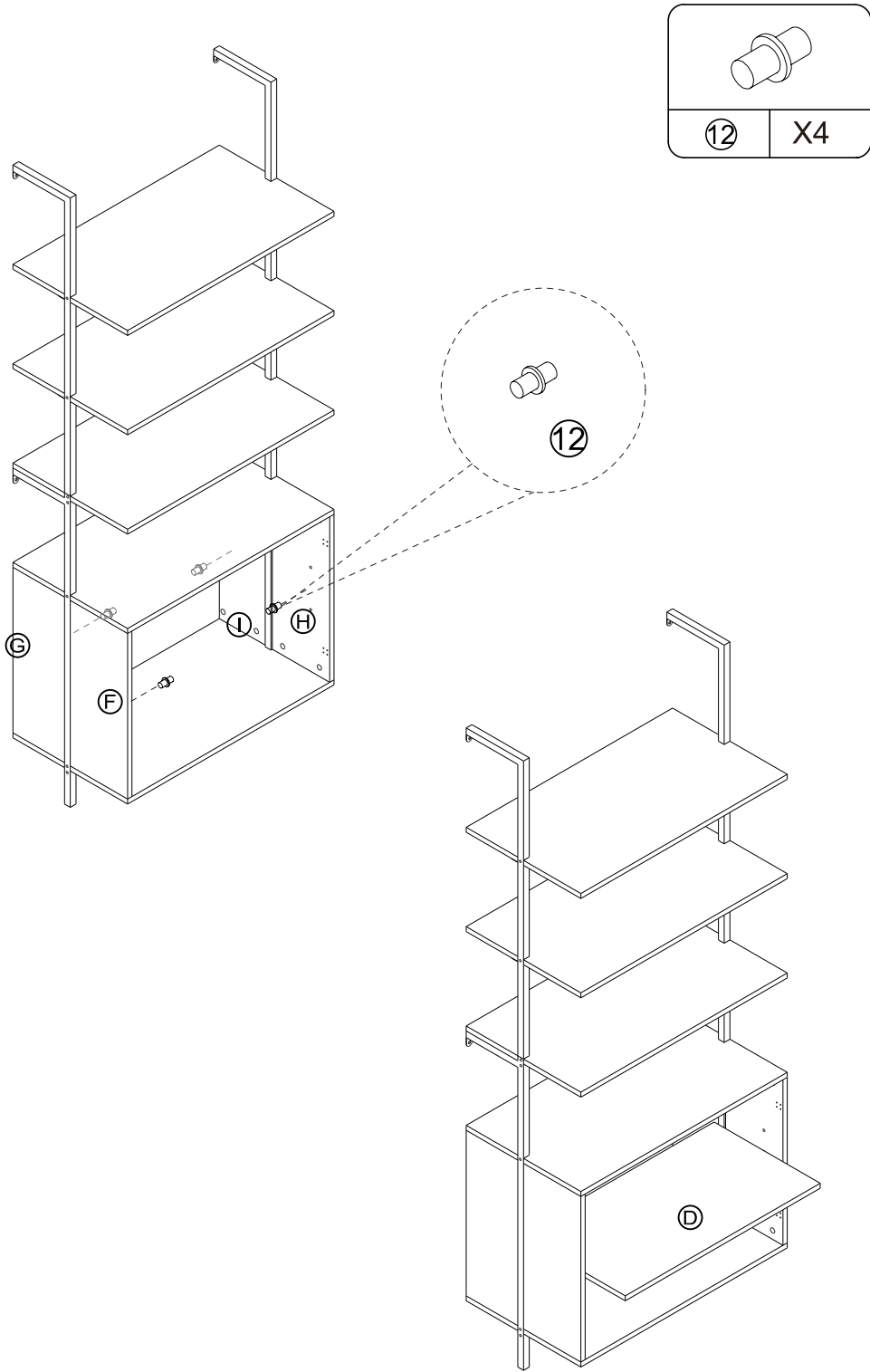



STEP4

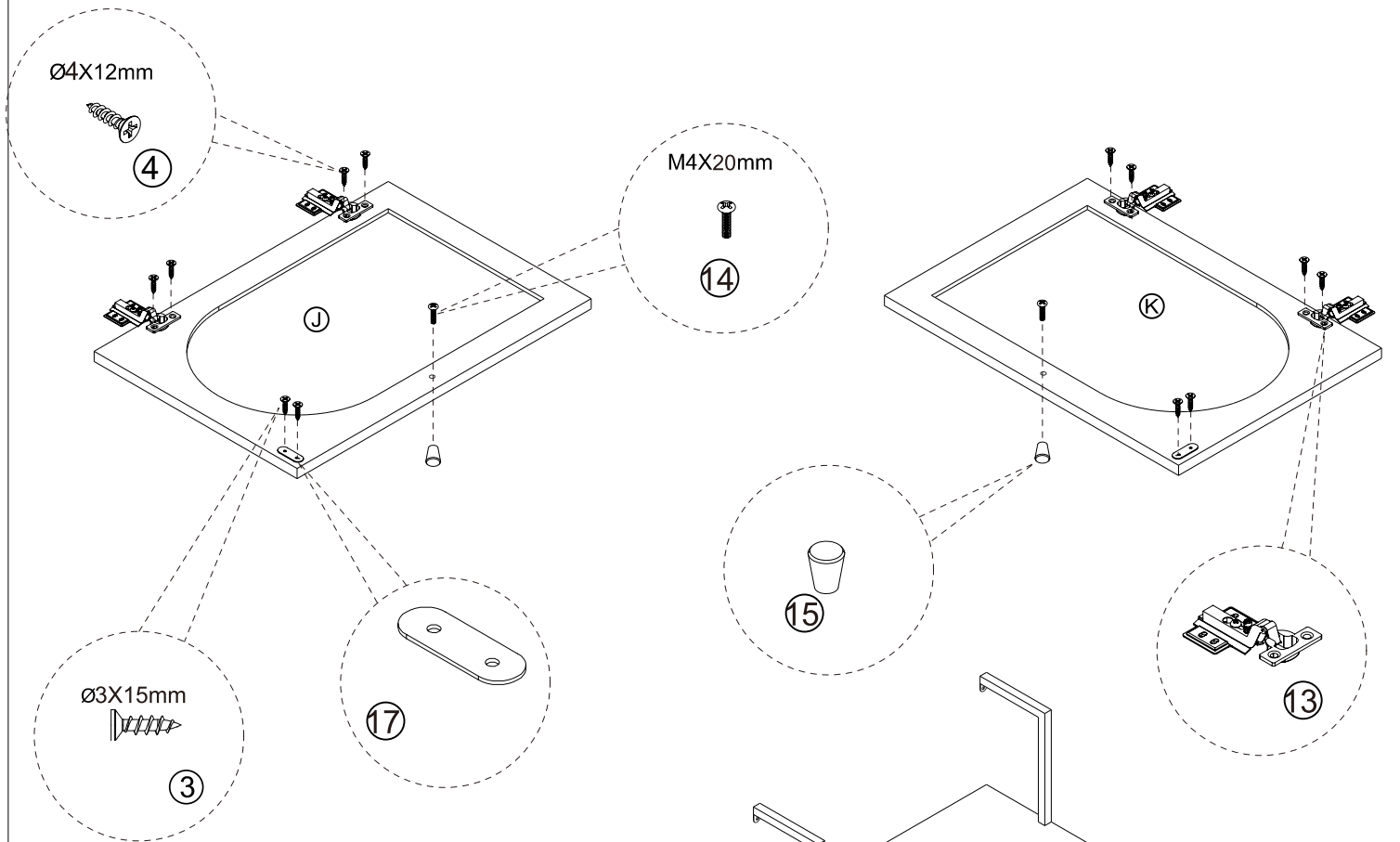

ASSEMBLY INSTRUCTION

STEP 5



| | |
|--|---|
|  $\varnothing 4 \times 12 \text{mm}$ |  |
| ④ X24 | ⑬ X4 |
|  M4X20mm |  $\varnothing 20 \times 24 \text{mm}$ |
| ⑭ X2 | ⑮ X2 |
|  $\varnothing 3 \times 15 \text{mm}$ |  $\varnothing 3 \times 15 \text{mm}$ |
| ⑰ X2 | ③ X4 |

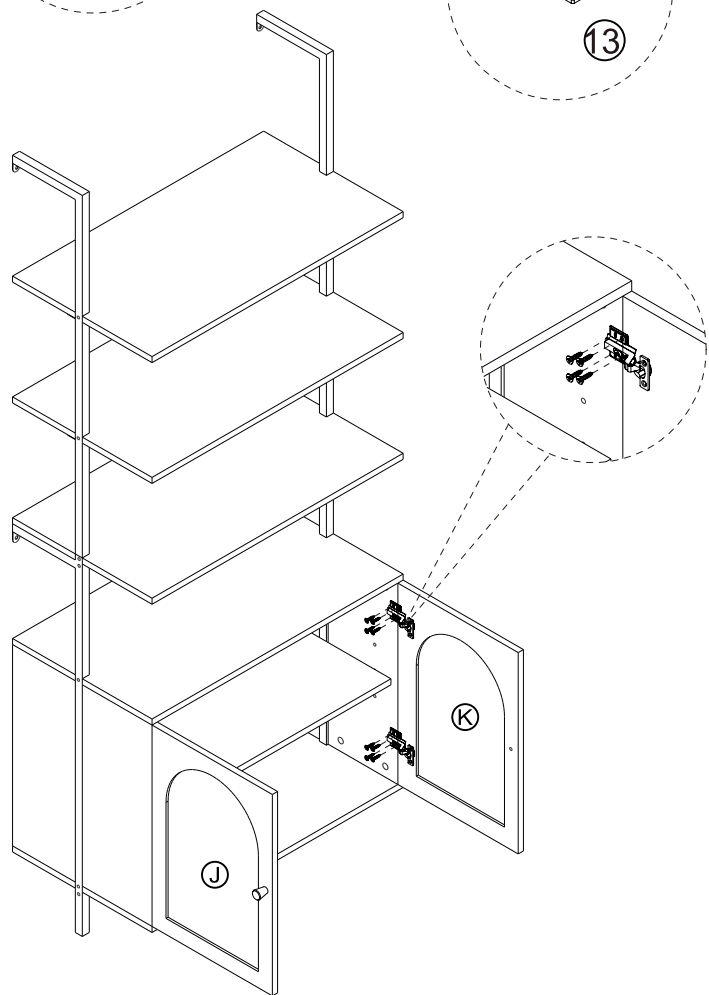

STEP 6

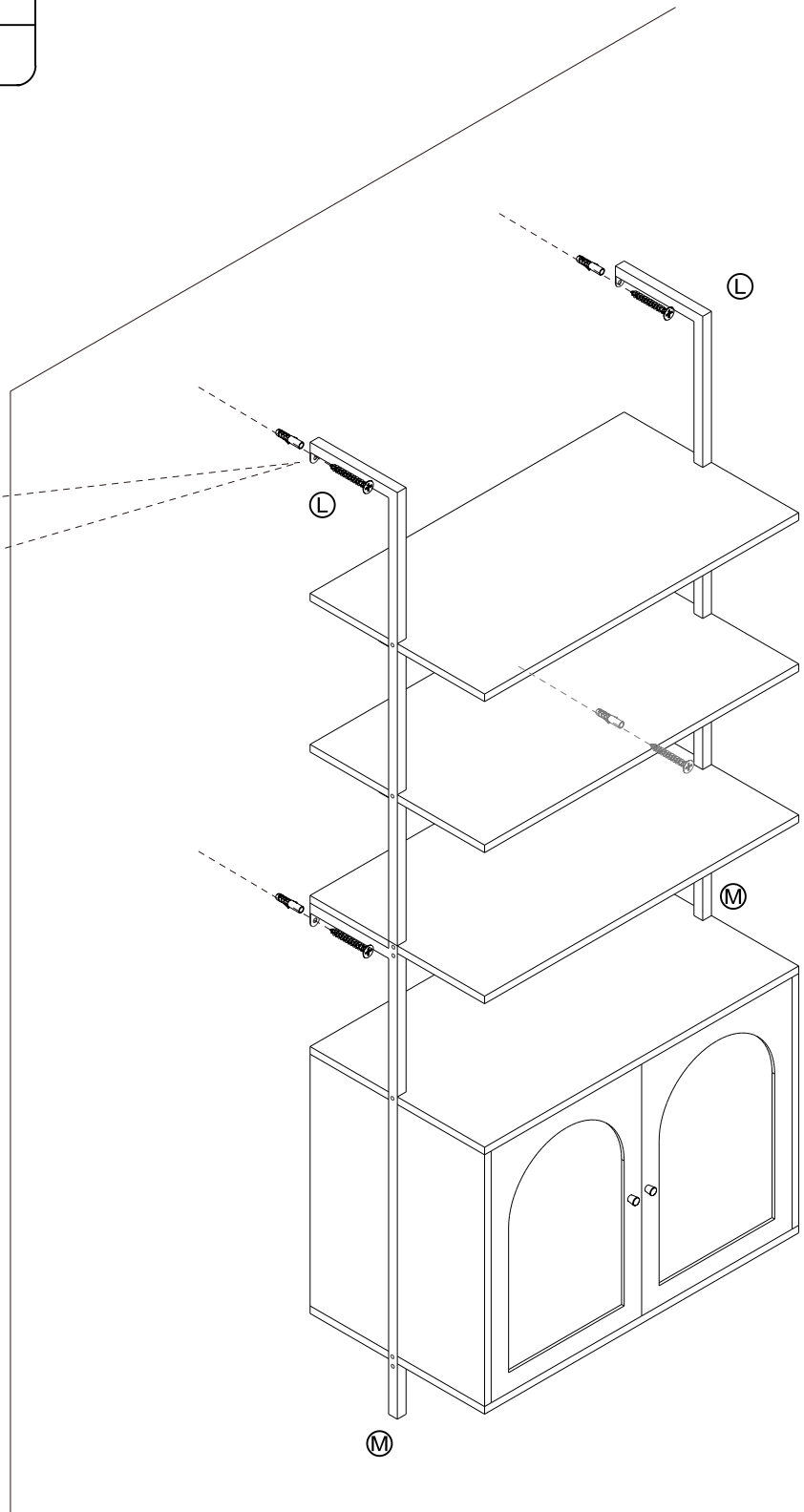
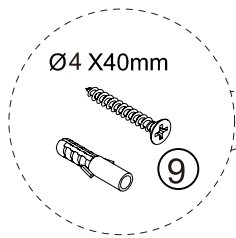
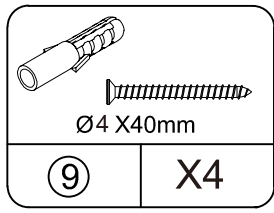

ASSEMBLY INSTRUCTION

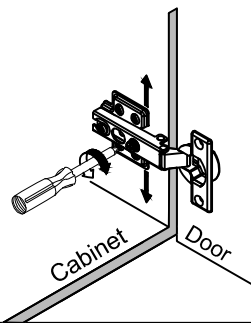
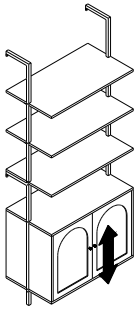
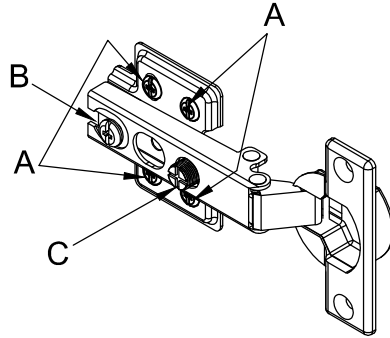

To adjust the vertical height.

Loosen the four screws "A" on both hinges. Two of them are usually in slotted holes which allows you to adjust up or down by a few mm. Then tighten back up.

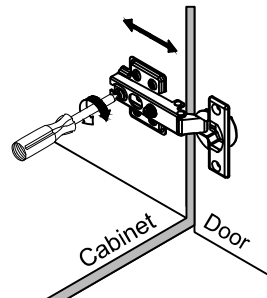
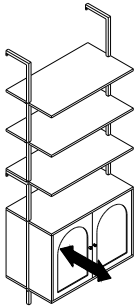

To adjust depth.

Loosen screw "B" and adjust door, if the door can not be adjusted, please loosen screw "C", then try again. Tighten screw "B" and "C".

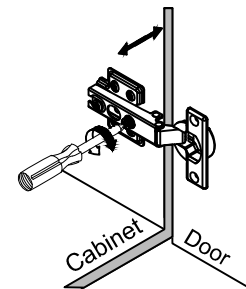
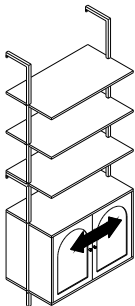

To adjust side ways.

Turning the screw "C" on BOTH hinges on each door.