

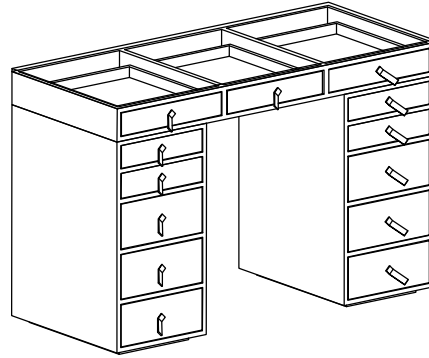





ASSEMBLY INSTRUCTION

Item NO:

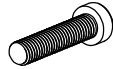

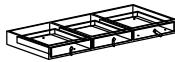
PARTS IDENTIFICATION				HARDWARE LIST			
A	Leg		1	Bolt		8pcs	
B	Leg		2	Flat waaber		8pcs	
C	Drawer		3	Allen key		1pcs	
D	Top panel	