

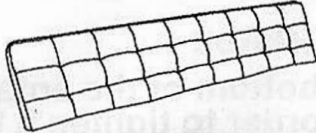

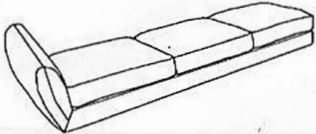

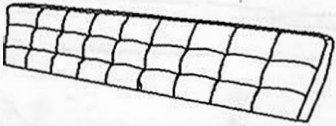
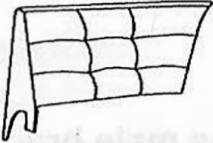
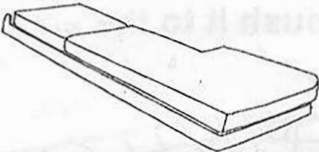

# Assembly Instruction

## 2-PCS SECTIONAL

Thanks for your purchasing our products. Please unpack the box and place the contents on a flat, level & soft surface. Please read this assembly instruction carefully and verify that you have all the parts before assembly. (Note: 2 people are required to safely assemble this product.)

### COMPONENT LIST

NO.	DRAWING	QTY	DESCRIPTION
A		1	LAF SOFA BACK REST
B		1	LAF SOFA SEAT
C		1	CHAISE RAF BACK
D		1	CHAISE LAF BACK
E		1	CHAISE SEAT
F		6	WOODEN LEG
G		4	PLASTIC LEG
H		6 PCS	
I		6 PCS	
J		6 PCS	
		1 PCS	

Please follow the drawings below to assemble the item.



Legs are stored at the bottom of the unit as shown with arrow sticker. Please take out the legs for assembly.

Step 1. Take out the leg from the bottom of the Sofa and Chaise.

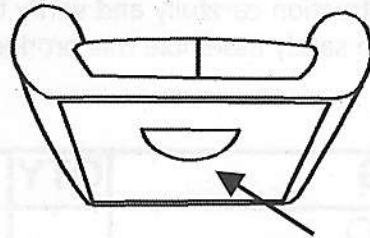

LEG INSIDE

Step 2. Attach legs onto the position at the bottom of the sofa/chaise as shown in drawing, rotate the legs in order to tighten it to the proper position.

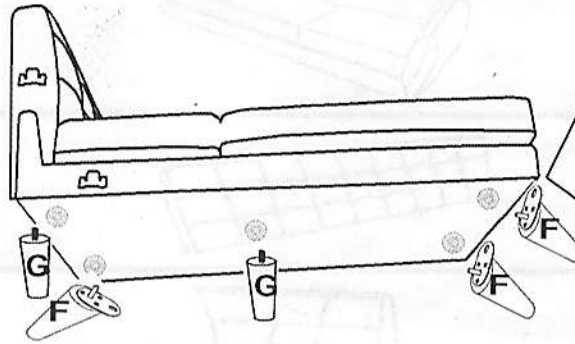
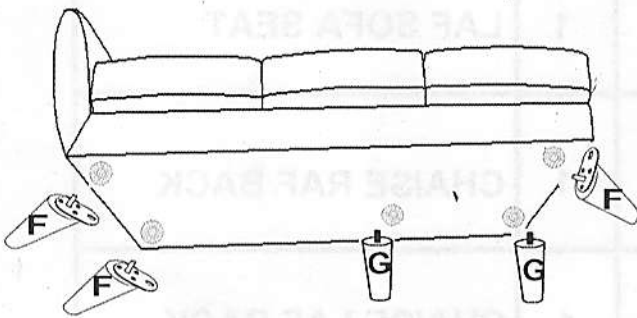

Step 3. Align female brackets at the back to the male brackets at the seat, insert the back rest to the seat and push it to the end, make sure the brackets is secured in position.

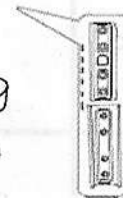
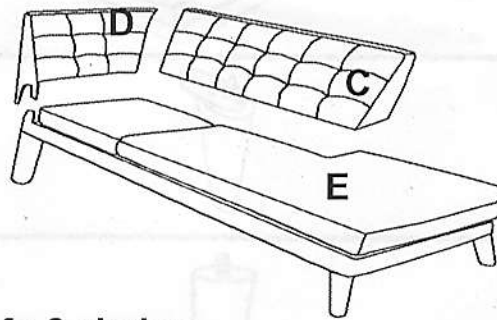
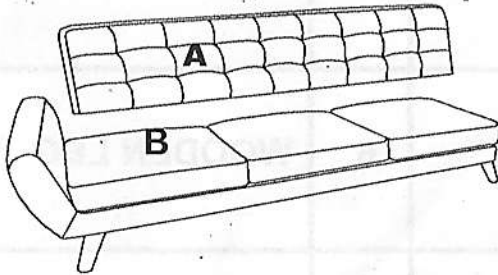

Step 4. Align the bracket at the side of sofa & chaise

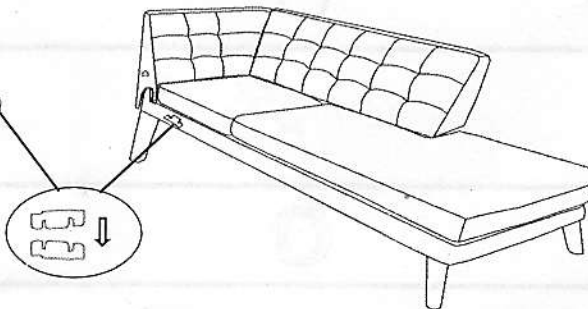
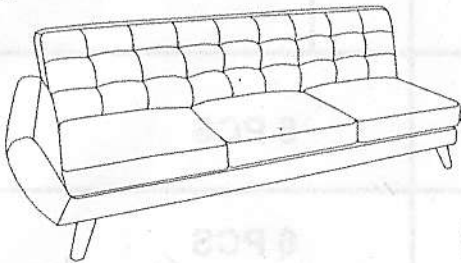

Step 5 Completed

