

THANKS FOR WATCHING

Your feedback is invaluable to us and we would love to hear about your experience. Please take the time to leave us a review.

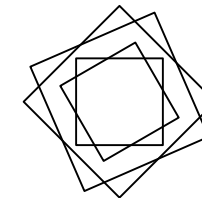

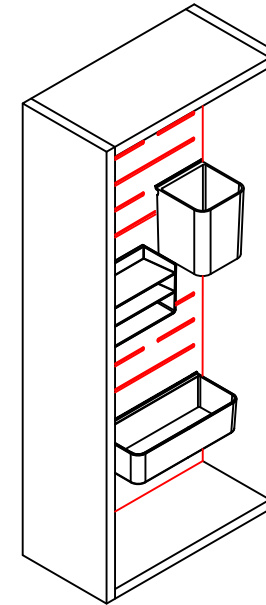





Thank you for shopping with us!

We encourage you to take a few minutes to go through this booklet. It contains important information on installation and care tips to keep your furniture looking as good as new.

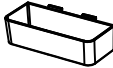
Item NO.: MC239E

Hardware

NO.	Draw	QTY	NO.	Draw	QTY
A	 45 degree wall hanging strip	2	E	 ZW-222 storage box	1
B	 Plastic anchor(Ø6mm)	4	F	 ZW-695 storage box	1
C	 (Ø4 x 45mm) Screws for fix on the wall	4	G	 ZW-695-1 storage box	1
D	 ZW-221 hook	1			

Dimensions

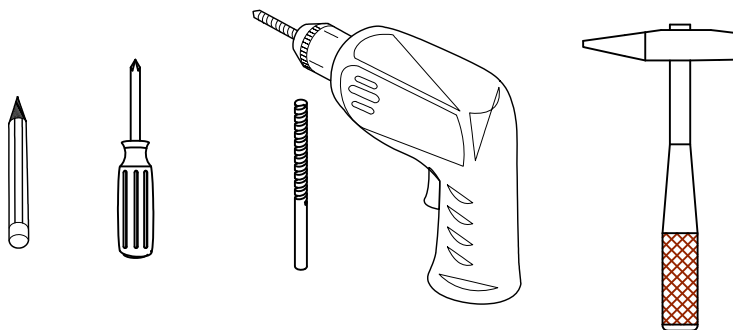

Dimensions

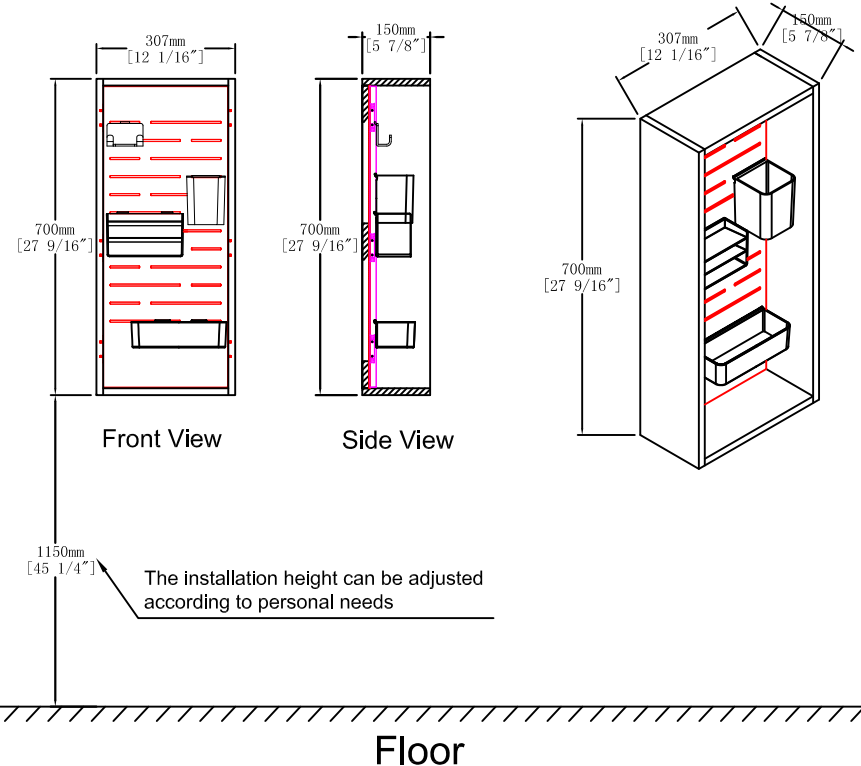

CARE CLEANING AND MAINTENANCE



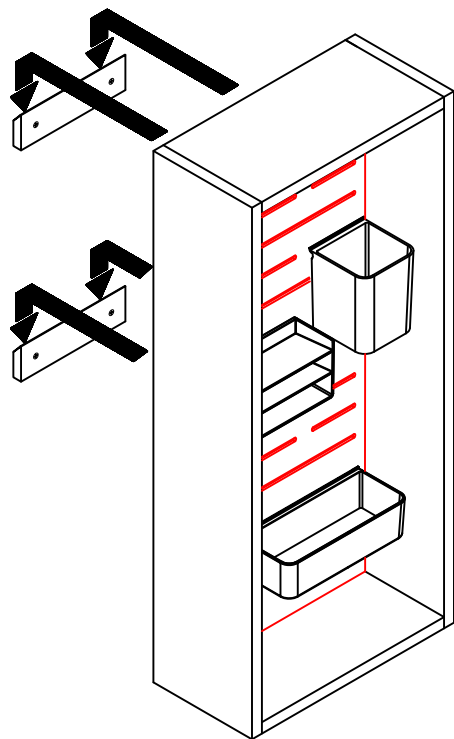

1. Dust regularly with a soft , dry cloth.
2. Avoid the use of all chemicals household cleaners, abrasives, or cleaners that contain lemon, vinegar, or other acids that may damage the finish.
3. Excessive exposure to sunlight and extreme changes in temperature and moisture can damage wood furniture.
4. Do not place hot appliances, such as curling irons and hot hair dryers directly on the countertop. Wipe spills immediately.

Finished

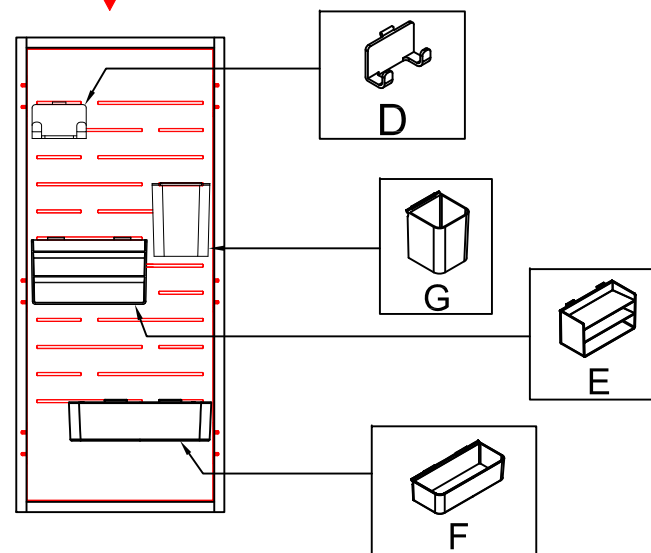
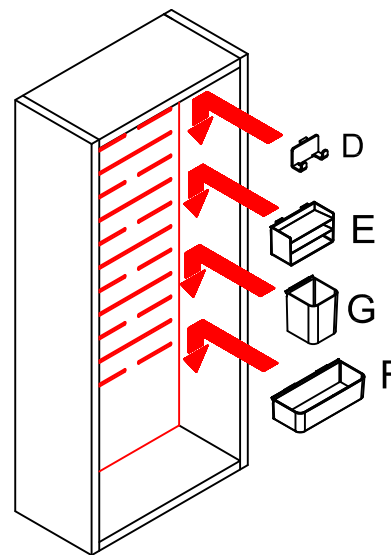

Step 1



	x1
D	
	x1
E	
	x1
F	
	x1
G	

Note: You can install storage accessories according to the diagram, or adjust the position of the storage box according to your own needs.

Step 2

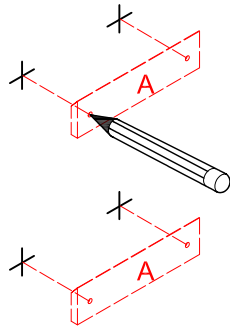
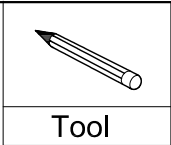

Step 4

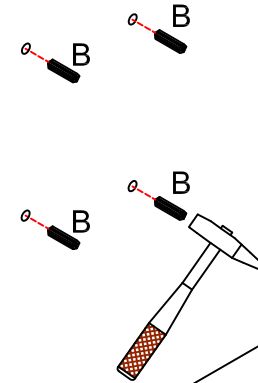
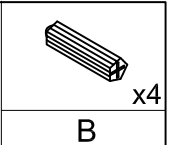

Step 3

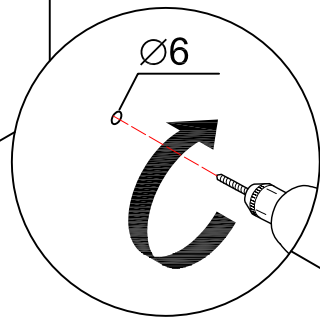
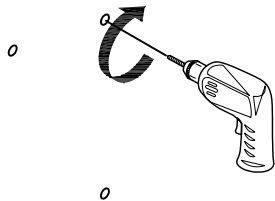

Step 5

