

ASSEMBLY INSTRUCTION

ASSEMBLY INSTRUCTION

ASSEMBLY TIPS:

- 1.Remove hardware from box and sort by size.
- 2.Please check to see that all hardware and parts are present prior to start of assembly.
- 3.Please follow attached instructions in the same sequence as numbered to assure fast & easy assembly.



Warning !

- 1.Don't attempt to repair or modify parts that are broken or defective.Please contact the store immediately.
- 2.This product is for home use only and not intended for commercial establishment.

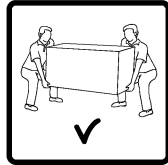

ASSEMBLY TIME PER UNIT: 40 MINUTES

PARTS IDENTIFICATION:

(A) SIDE PANEL

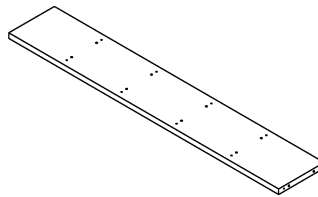

1PC

(B) BOTTOM PANEL

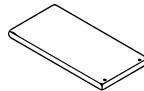

1PC

(C) CROSS PANEL

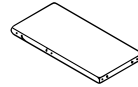

4PCS

(D) TOP PANEL

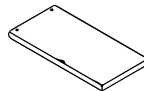



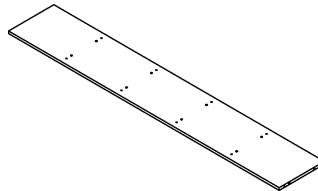

1PC

(E) BACK PANEL

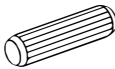
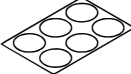

1PC

Z	HARDWARE PACKAGE						
NO	DESCRIPTION	FIGURE	Q'TY	NO	DESCRIPTION	FIGURE	Q'TY
1	GLUE 40g		1PC	4	SCREW $\phi 4.5 \times 42 \text{mm}$		8PCS
2	WOODEN DOWEL $\phi 8 \times 30 \text{mm}$		24PCS	5	STICKER $\phi 20 \text{mm}$		4PCS
3	BOLT $\phi 9.5 \times 55 \text{mm}$		16PCS				

STEP 2 :

Apply glue on all wooden dowels to ensure integrity of the structure.

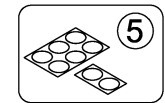
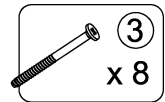
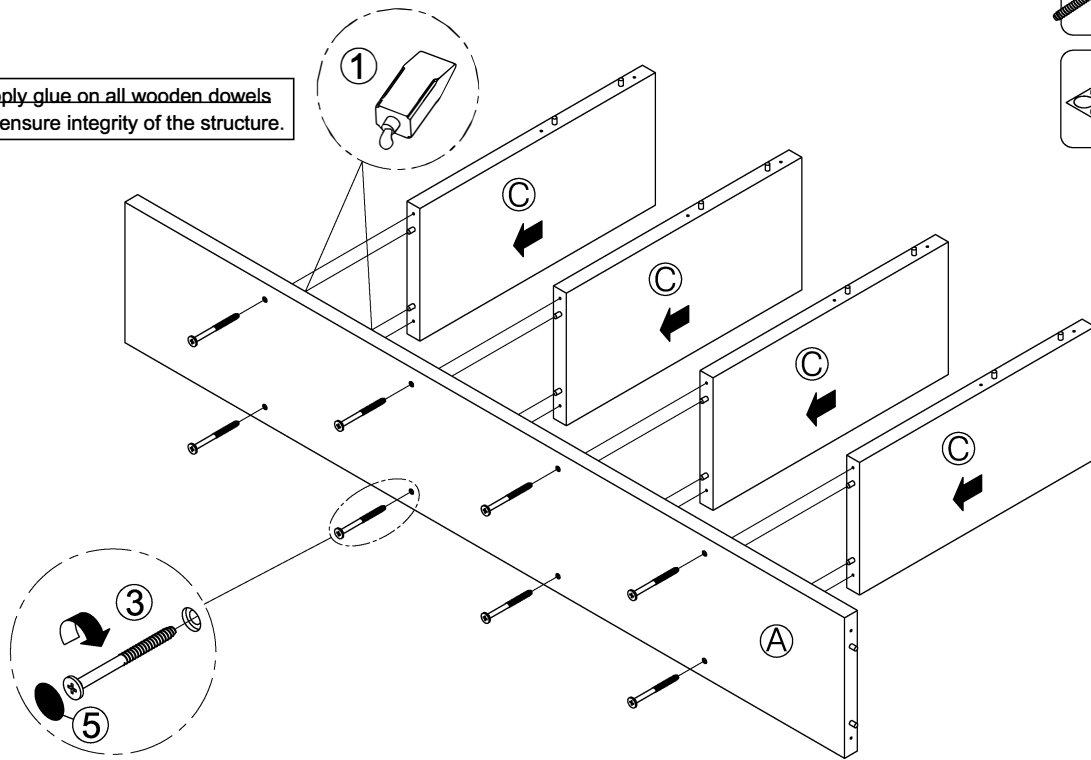

STEP 3 :

Apply glue on all wooden dowels to ensure integrity of the structure.

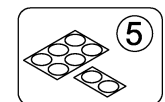
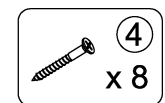
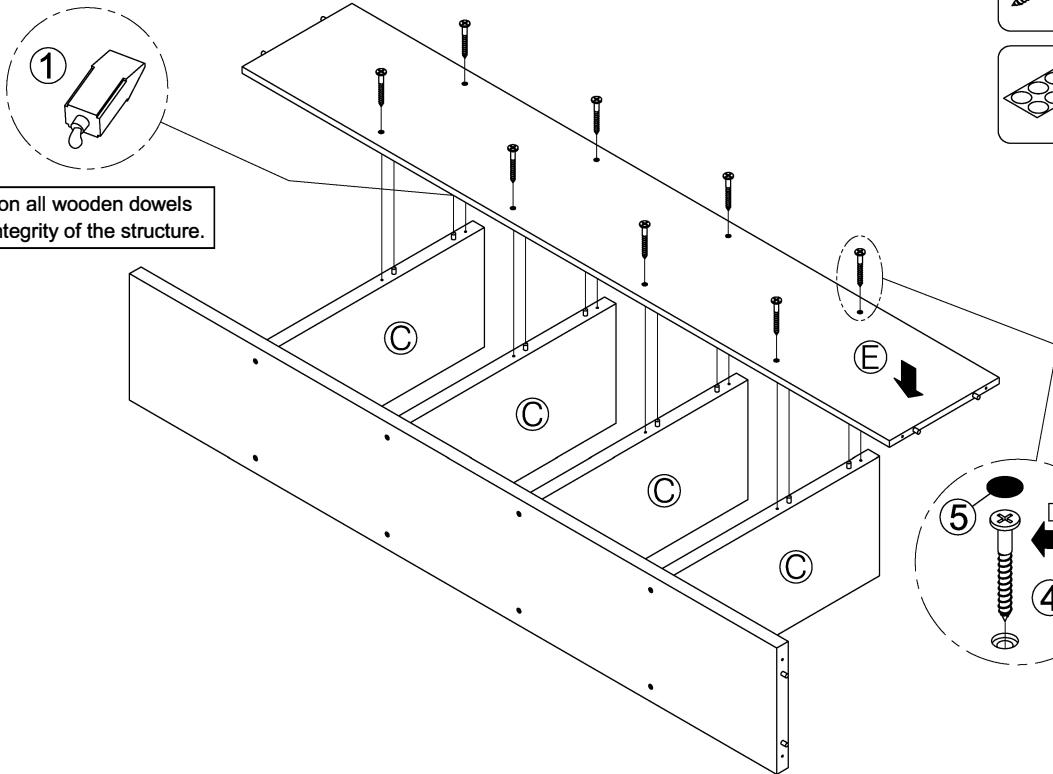

STEP 4 :

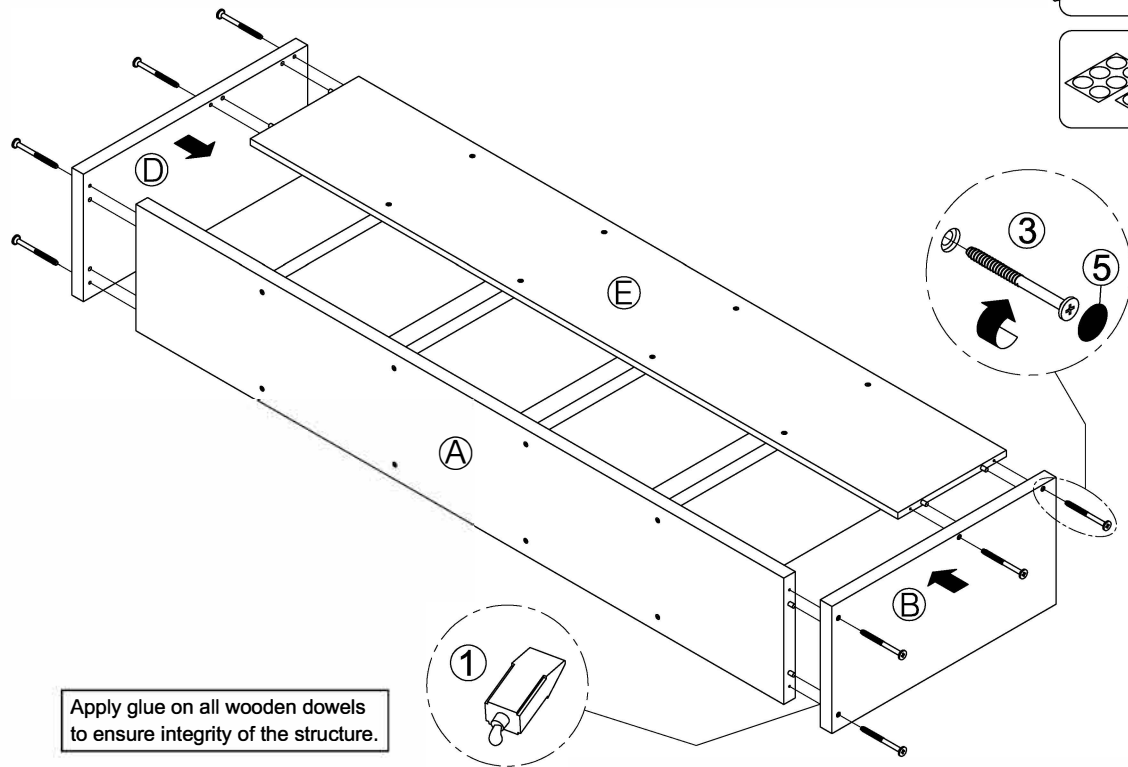

Apply glue on all wooden dowels to ensure integrity of the structure.

STEP 5 :

ATTENTION: ANTI TIPPING SAFEGUARD

Please install the anti-tipping hardware as shown in the drawing. This can help to prevent any tipping issues.

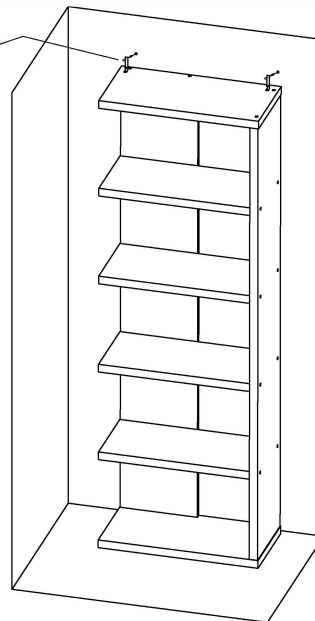
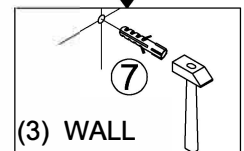
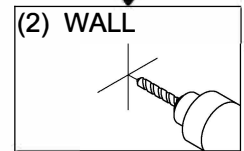
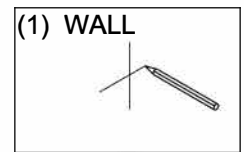
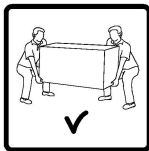
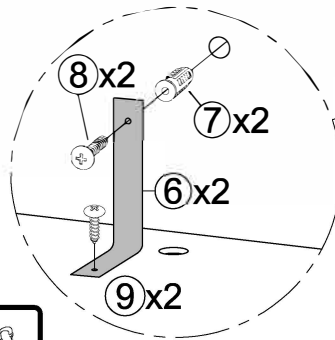

WARNING

Injury may result from tipping furniture

This restraint is not a substitute for proper adult supervision.
 This restraint may provide protection against tipping furniture.
 Do not allow children to climb on furniture.
 Failure to detach this restraint before moving furniture may result in injury and damage