









Assembly Instruction

PartsList			
Item	Description	Part	Qty Pcs
1	Table Top		1
2	Bottom frame		1
3	Foot		1
4	Foot		1

HardwareList			
Item	Description	Part	Qty Pcs
A	Allen Wrench		1
B	Bolt		12
C	Spring washer(ø8)		12
D	Metalwasher		12

- 1、 Please check all items against the product list to ensure nothing is missing. Contact us at any time if any parts are not included.
- 2、 Before installation, place the packing foam from the box or prepare a thick cushion on the floor to protect the mirrored surface from scratches.

STEP 1

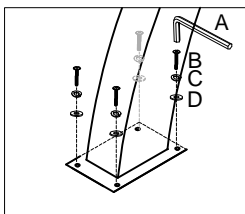

Place four screws inside before starting to tighten them

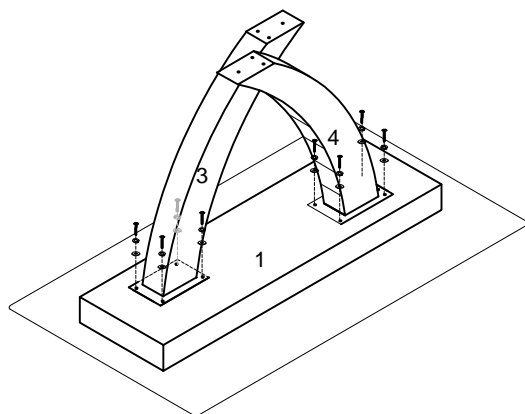
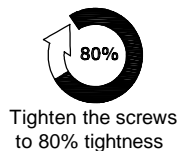

Place EPS or blankets underneath the product to prevent damage to the mirror surface

Two people work together to lift the top and slowly flip it over

STEP 2

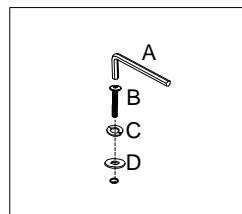

Place four screws inside before starting to tighten them



Adjust the chair balance, then tighten the screws to 100% tightness

